

Ls79_CATALISTINO_PARETI DOCCIA





Con il nuovo catalogo abbiamo voluto presentarvi una nuova linea che sfida le leggi della fisica.

Il nuovo astro di SAMO è Pyxis: la risposta alla tendenza che vuole una parete doccia con telaio quasi invisibile, mantenendo le caratteristiche di robustezza e solidità di una doccia tradizionale. I profili delle pareti doccia hanno un tratto minimo, simile a un bordo che la delinea.

Così gli antichi Greci, scrutando l'orizzonte, si affidavano alle flebili luci della costellazione Pyxis per trovare la rotta di casa dopo un lungo viaggio in mare.

Con le stelle di Samo si riconosce sempre la rotta giusta per approdare comodamente a casa!

Il mio augurio è quello che possiate far vostra anche questa nuova proposta di successo.

Il presidente
Denis Venturato

NEW

- 26 Pyxis,**
nuova collezione
- 48 Open,**
nuove finiture L73 e .76 Sage opaco, L86 e .86 Ambra opaco
- 100 Grand Polaris,**
nuove finiture L91 Bianco opaco e L96 Nero opaco
- 116 Acrux,**
nuove immagini
- 222 Cee Art,**
nuove immagini
- 246 Polaris,**
nuove finiture L91 Bianco opaco
- 272 Alter,**
nuove immagini e nuove finiture L91 Bianco opaco e L96 Nero opaco
- 286 America quattro SP,**
nuove finiture L96 Nero opaco
- 300 America quattro,**
nuove finiture L96 Nero opaco

Indice generale



04	Portfolio
06	Finiture pannelli e finiture profili
08	Finiture dei piatti doccia
10	Come creare il codice
14	Stampa digitale su vetro piano
18	Certificazione EPD
20	Sostenibilità ambientale
22	Responsabilità
24	Istà e Fòra
26	Pyxis
58	Open Side con mensola
60	Open Side parete fissa con mensola per abbinamenti
62	Open Deflettore
64	Open Scorrevole
66	Kit Open scorrevole per chiusura in nicchia
68	Parete fissa per Open scorrevole
70	Open Side
72	Open Shot
74	Open Screen
76	Combinazioni Open
78	Sistemi di fissaggio, palo pavimento-soffitto
80	Zenith
100	Grand Polaris
116	Acrux
138	Europa SP
156	Europa
190	Piatti doccia StoneFit
198	Pannelli rivestimenti StoneFit
200	Piatti doccia Stone
204	Cee Art SP
222	Cee Art
246	Polaris
272	Alter
278	Flex
286	America quattro SP
300	America quattro
314	America
328	Ciao
334	Pareti Vasca
346	Prodotti Speciali
366	Profili Speciali
368	Profili di Compensazione
374	Ricambi
390	Servizi di pre e post vendita
392	La Qualità - I Materiali
394	StarClean - Raccomandazioni utili per la Pulizia
396	e-samo Web Services
398	Condizioni generali di trasporto e vendita

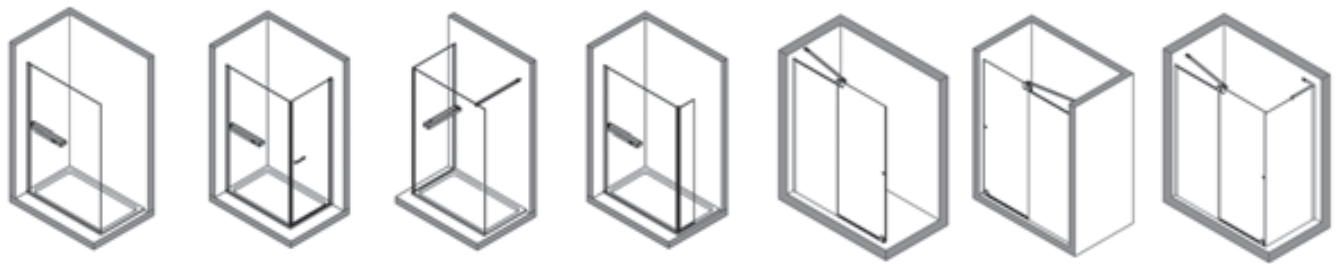

OPEN	p. 58	p. 59	p. 60	p. 62	p.64	p. 66	p. 68
------	-------	-------	-------	-------	------	-------	-------

angolo scorrevole	angolo battente	angolo ripieghevole	porta battente	porta con fisso in linea	porta battente 3 ante	porta battente 4 ante
-------------------	-----------------	---------------------	----------------	--------------------------	-----------------------	-----------------------



PYXIS	Prossimamente in arrivo			p. 44 - 46	p. 40 - 42	
-------	-------------------------	--	--	------------	------------	--

ZENITH		p. 90		p. 92		p. 96
--------	--	-------	--	-------	--	-------

GRAND POLARIS		p. 110		p. 112 - 114		
---------------	--	--------	--	--------------	--	--

ACRUX	p. 126			p. 134		
-------	--------	--	--	--------	--	--

EUROPA SP	p. 146				p. 150	
-----------	--------	--	--	--	--------	--

EUROPA	p. 164			p. 174 - 176	p. 168 - 170	
--------	--------	--	--	--------------	--------------	--

CEE ART SP	p. 212					
------------	--------	--	--	--	--	--

CEE ART	p. 230			p. 236		
---------	--------	--	--	--------	--	--

POLARIS - ALTER		p. 254 - 258 - 276	p. 272	p. 256 - 260 - 274	p. 264	p. 266
-----------------	--	--------------------	--------	--------------------	--------	--------

AMERICA QUATTRO SP	p. 290 - 291- 292					
--------------------	-------------------	--	--	--	--	--

AMERICA QUATTRO	p. 302-303-304			p. 309		
-----------------	----------------	--	--	--------	--	--

AMERICA	p. 316-318			p. 321		
---------	------------	--	--	--------	--	--

CIAO	p. 330					
------	--------	--	--	--	--	--

FLEX			p. 280 - 281			
------	--	--	--------------	--	--	--



p. 67



p. 67



p. 70



p. 71



p. 72



p. 74

porta soffietto



porta saloon



porta scorrevole 2/3 ante



porta scorrevole 4 ante



tondo scorrevole 2 ante



tondo scorrevole 4 ante



tondo battente 2/4 ante



parete fissa



p. 36 - 38

p. 38-42-46

p. 94 - 98

p. 112

p. 128 - 130

p. 132

p. 136

p. 148

p.152

p.154

p. 178

p. 180

p. 166

p. 172

p. 164

p. 182-184

p. 188

p. 214 - 216

p. 218

p. 220

p. 240

p. 238

p. 232

p. 234

p. 242

p. 244

p. 262

p. 268

p. 270

p. 297

p. 294

p. 296

p. 298

p. 310

p. 311

p. 306 - 308

p. 312

p. 313

p. 323

p. 322

p. 317

p. 320

p. 324-325

p. 326

p. 331

p. 332

p. 284

Finitura pannelli

Vetro temperato

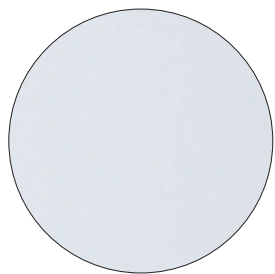

TR
trasparente

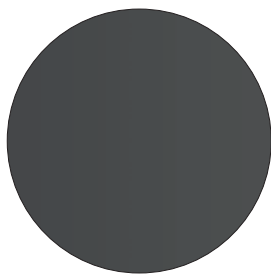

TG
trasparente Grigio

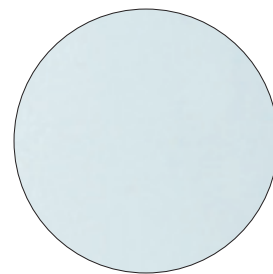

AS
satinato Acqua

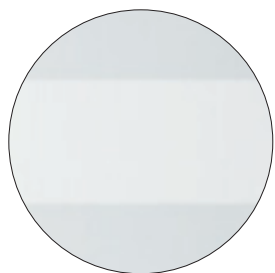

RF
trasparente
con fascia Satinata

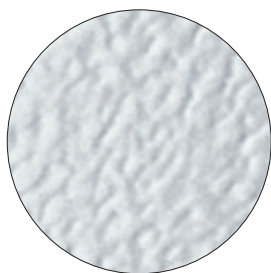

ST
stampato

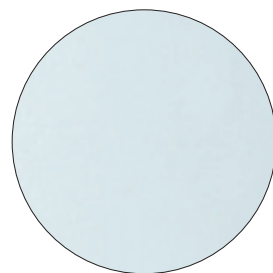

RS
satinato
(negli stondati all'interno)

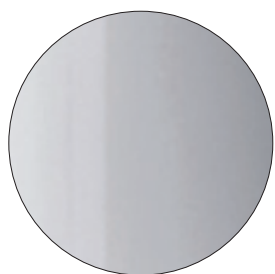

SY
vetro a specchio

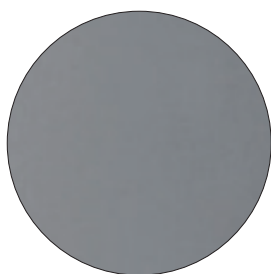

GS
grigio satinato

Polystyrene



SE
Setola



JU
Juta

Alluminio

Finitura profili

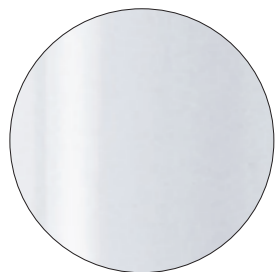

L01
bianco

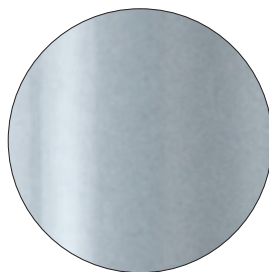

SAR
satinato argento

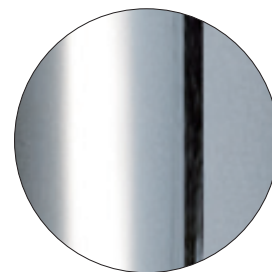

ULU
brillantato Cromo



NEW
SNK
nickel spazzolato opaco



NEW
AL4
bronzo spazzolato opaco

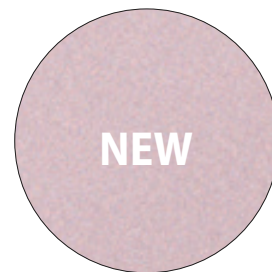

NEW
L55
rosa metallizzato opaco



NEW
L73
sage opaco

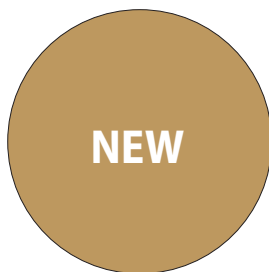

NEW
L86
ambra opaco

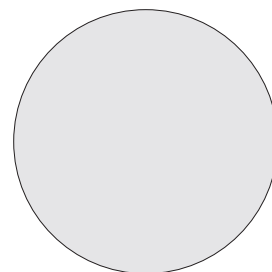

L90
artic opaco

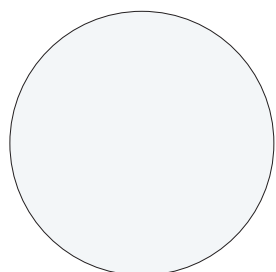

L91
bianco opaco

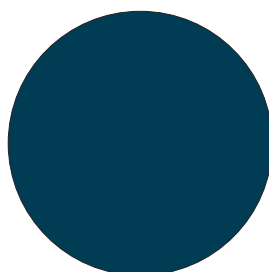

L92
sailor blue opaco

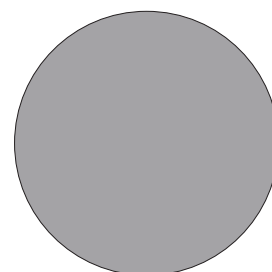

L95
grigio opaco

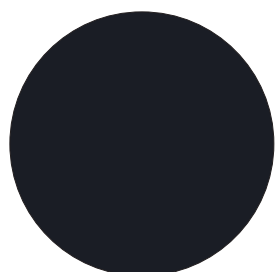

L96
nero opaco

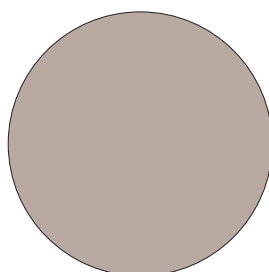

L98
sabbia opaco

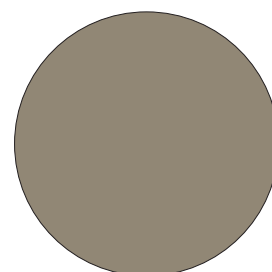

L99
tortora opaco

Finitura piatti

StoneFit



R01
bianco



R06
nero



R08
sabbia



R10
arctic



R17
grigio

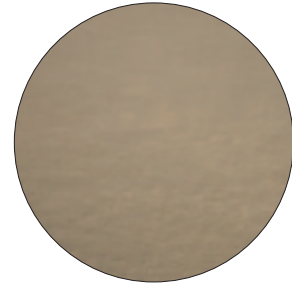

R19
tortora

Stone



R01
bianco



R06
nero

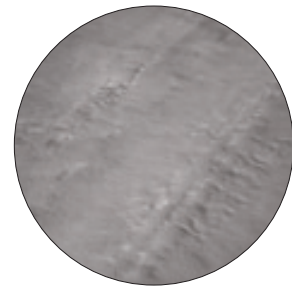

R17
grigio

Finitura accessori

Metacrilato

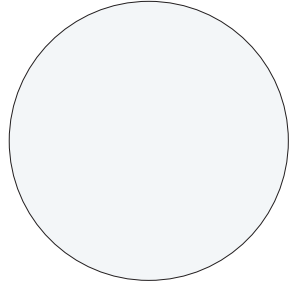

.80
bianco

Alluminio

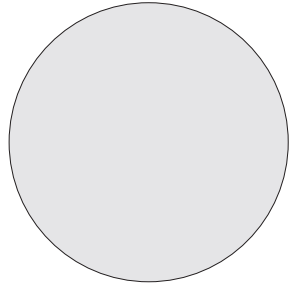

.09
bianco goffrato

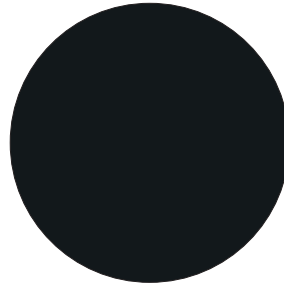

.18
nero goffrato

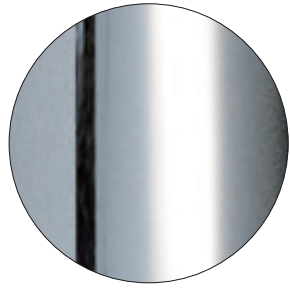

.29
brillantato cromo



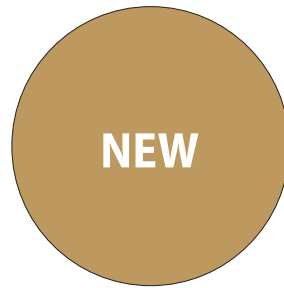

NEW
.73
sage opaco



NEW
.86
ambra opaco

Come comporre il codice

Z [cm]	Cod.	Z1 [cm]	A [cm]	B [cm]	C [cm]	 [dm³]	 [kg]	 [n°]	L01 [€]
64-66,5	B3750	62,2-68,7	//	//	//	99	29	1	TR
									AS
									RF

B **3750** **L01** **TR** **DX**
/M

Identifica la particolarità del prodotto
(Non è sempre necessaria)
DX = versione destra o lato destro
/M = un solo lato reversibile

Finitura pannelli
TR = vetro trasparente

Finitura profili
L01 = bianco

Serie, modello e misura del prodotto
3750 = Grand Polaris, parete fissa per abbinamento con lanto angolo, 64-66,5 cm.

Tipologia di prodotto
B = cabina doccia

Come comporre il codice di un prodotto speciale

Z [cm]	Cod.	Z1 [cm]	A [cm]	B [cm]	C [cm]	 [dm³]	 [kg]	 [n°]	L01 [€]
64-66,5	B3750	62,2-68,7	//	//	//	99	29	1	TR
									AS
									RF

B S 3750 L01 TR

Per la creazione del codice del prodotto speciale bisogna aggiungere la lettera **S** tra la lettera **B** (Tipologia di prodotto) e il numero di Serie del modello-misura

Standard	Tipo (Livello)	Forme SPECIALI			
 ALTEZZA standard e LARGHEZZA standard di riferimento	I	 ALTEZZA inferiore	 ALTEZZA superiore	 LARGHEZZA inferiore	 LARGHEZZA superiore
	II	 ALTEZZA inferiore LARGHEZZA inferiore	 ALTEZZA superiore LARGHEZZA inferiore	 ALTEZZA inferiore LARGHEZZA superiore	 ALTEZZA superiore LARGHEZZA superiore
	III	 VETRO ritagliato	 VETRO sopra muretto	 VETRO sagomato	 LARGHEZZA ante personalizzata
	IIII	SOLUZIONI DIVERSE da quelle contemplate nei livelli I, II, III: si veda la sezione dedicata da pag. 352 a pag. 363 CONTATTARE UFFICIO CLIENTI per avere la fattibilità e il prezzo			

LARGHEZZE INTERMEDIE: sommare al prezzo della misura superiore.

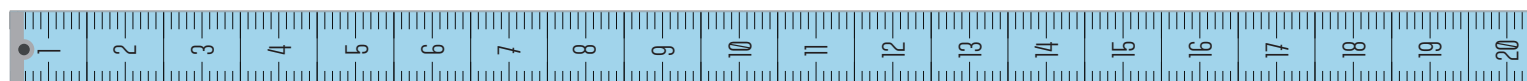

Siamo Samo



60+ anni di storia imprenditoriale

230+ dipendenti

50+ MLN di € fatturato

55.000 m² di stabilimenti produttivi

1.000+ cabine doccia prodotte al giorno

Siamo digitali

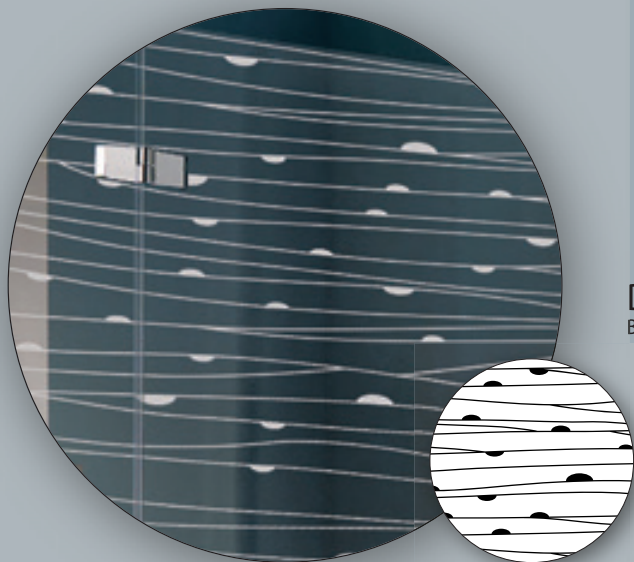

DD
Brezza

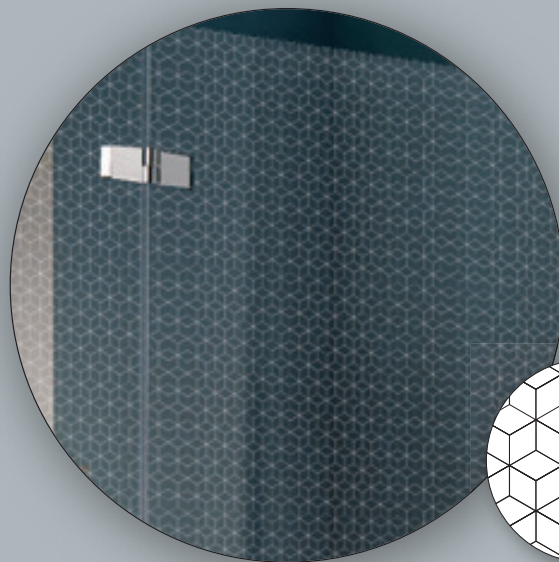

DH
Cubix



DI
Fronda

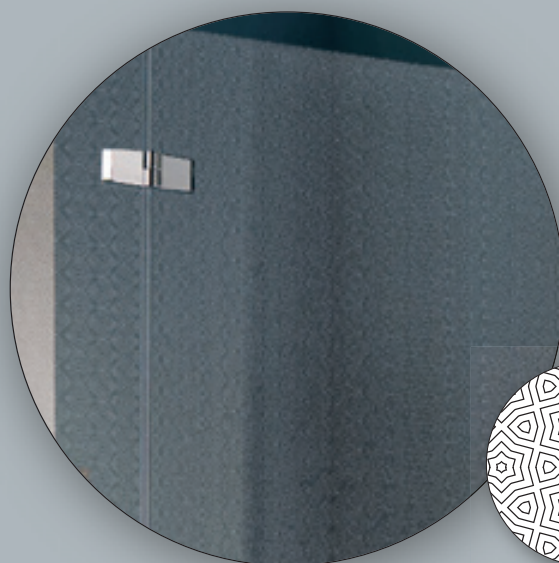

DK
Exagon

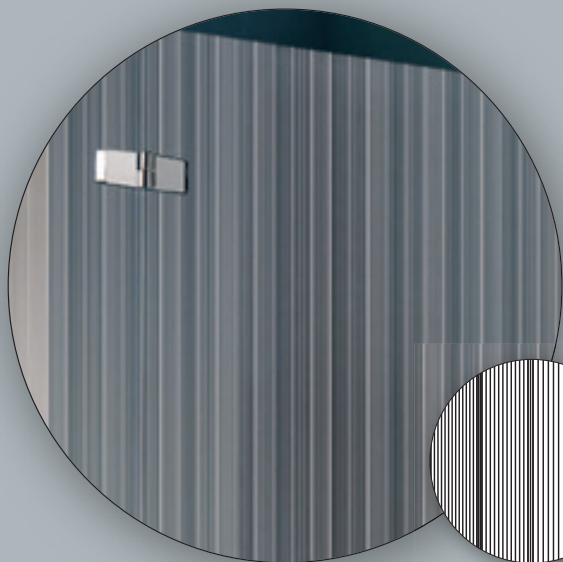

DM
Wave

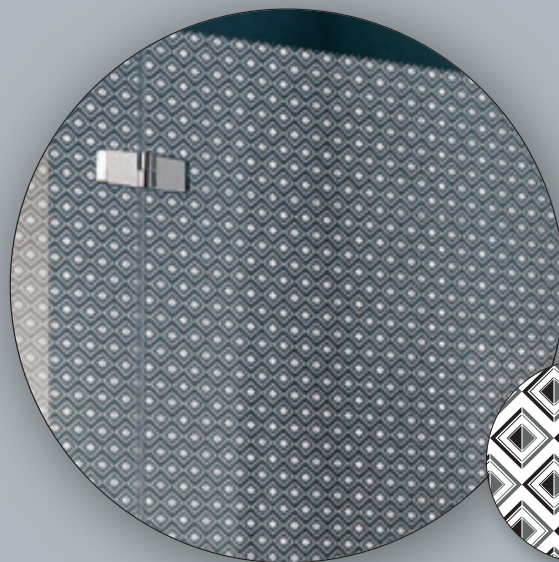

DN
Rombi

Stampa digitale

La tecnologia di stampa digitale su vetro è una tecnica avanzata che permette di stampare, su lastre in vetro temperato, immagini e fotografie, disegni e scritte ricevute tramite un supporto digitale. Si tratta di una stampa ad alta definizione e in quadricromia: il getto d'inchiostro ceramico a 4 colori in un'unica applicazione garantisce un'ottima risoluzione dell'immagine sulla superficie del vetro e la massima durata nel tempo, ricreando infinite sfumature. In particolare la stampa digitale consiste nell'utilizzo di speciali vernici ceramiche che, vetrificando durante il processo di tempra, garantiscono inalterata nel tempo la qualità dell'immagine impressa sul vetro.

Il processo di serigrafia è stato fino ad ora il solo modo di decorare vetri con vernici colorate.

La serigrafia necessita dell'utilizzo di specifici telai serigrafici per applicare la vernice e riprodurre l'immagine ed è possibile applicare un solo colore alla volta senza poter donare all'immagine sfumature o gradazioni cromatiche.

Con la stampa digitale le immagini, le fotografie e i disegni sono elaborati da un software dedicato della stampante che riproduce fedelmente il soggetto utilizzando contemporaneamente i 4 colori in un unico passaggio di stampa garantendo, quindi, un'altissima qualità di definizione, colori con sfumature e giochi di trasparenza.

Stampe il cui aspetto, intensità e colore, non si sbiadiranno con il tempo per il contatto con l'acqua o l'uso quotidiano della parete doccia.

L'immagine da stampare dovrà essere in alta risoluzione (risoluzione di almeno 300 DPI, dimensioni minime 21x30cm) in formato digitale (.jpg, .tif, .eps, .raw) o in formato vettoriale (.ai). La stampa digitale è realizzabile su vetri con superfici perfettamente lisce: TR trasparente (consigliato); TG trasparente grigio.

È possibile la stampa anche di immagini personalizzate. Non è possibile realizzare stampe digitali su vetri con finiture acidate, vetri stampati o satinati.

Attenzione: la percezione visiva di un'immagine può cambiare a seconda del supporto sulla quale viene realizzata: la stessa immagine ha una resa cromatica diversa a seconda che venga stampata su carta, vetro, o a video.

Siamo tecnologici



Incollaggio UV

Soluzione ideale per il fissaggio della componentistica, è la tecnologia d'incollaggio UV, mutuato dalla tecnologia aerea, che ha trovato una grande applicazione nell'industria del vetro in quanto consente di ottenere incollaggi invisibili, ma dotati di un'elevata resistenza meccanica.

Nel corso di questi ultimi anni, il gruppo Samo Industries ha sviluppato questa tecnologia su alcuni dei suoi prodotti. Rispetto all'incollaggio tradizionale, dove l'adesivo viene lasciato asciugare reagendo con l'aria o altre sostanze reagenti, questa tecnologia impiega speciali lampade che emettono raggi UV.

Le colle utilizzate per questa tecnologia polimerizzano una volta esposte ai raggi ultravioletti, garantendo una rapida e sicura giunzione delle parti da unire.

Con questa tecnologia si possono incollare svariate tipologie di materiale, spaziando per diversi settori di utilizzo. Nel nostro caso, questa tecnica è applicata nella giunzione di elementi metallici (cerniere, zanche, maniglie) al vetro.

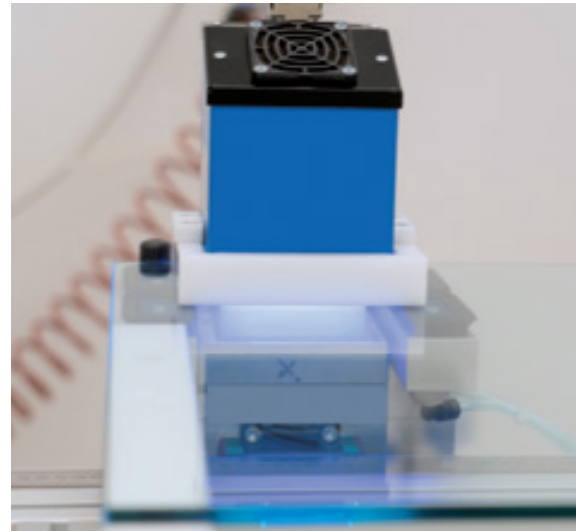

Siamo certificati



Il gruppo Samo Industries prosegue la propria missione di tutela nei confronti dell'ambiente e ottiene la prima dichiarazione **EPD** per pareti doccia al mondo per una selezione di prodotti Samo, grazie a un lavoro iniziato nel 2015 condotto in sinergia con il "Gruppo di Lavoro Tecnico Cabine Doccia" all'interno di Assobagno.

L'EPD (Environmental Product Declaration) è una dichiarazione ambientale verificata da un ente indipendente e riconosciuta a livello internazionale che comunica le performance ambientali di un prodotto attraverso l'uso di informazioni oggettive, confrontabili e credibili, considerando variabili come il consumo energetico e di materie prime, le emissioni atmosferiche, la produzione di rifiuti e gli scarichi in corpi idrici. Non si tratta semplicemente di avere a cuore l'ambiente, ma di impegnarsi a fare passi concreti in direzione di una nuova visione industriale che sia davvero sostenibile.

Il conseguimento di questa dichiarazione, oltre ad attestare la sensibilità del Gruppo alle tematiche ambientali, porta un valore aggiunto al prodotto, in quanto il cliente finale acquista un elemento di altissima qualità con un'etichetta ambientale trasparente, mentre progettisti e professionisti del settore si trovano a lavorare con prodotti già certificati in vista del conseguimento di dichiarazioni ambientali complessive per i propri progetti.

La certificazione dei prodotti si è incentrata su un totale di tre modelli:

Cee Art

(parete doccia con porte scorrevoli a telaio integrale)

Polaris

(parete doccia con porta battente e parete fissa senza telaio)

Open Side

(parete divisoria a tutto vetro).

Siamo sostenibili

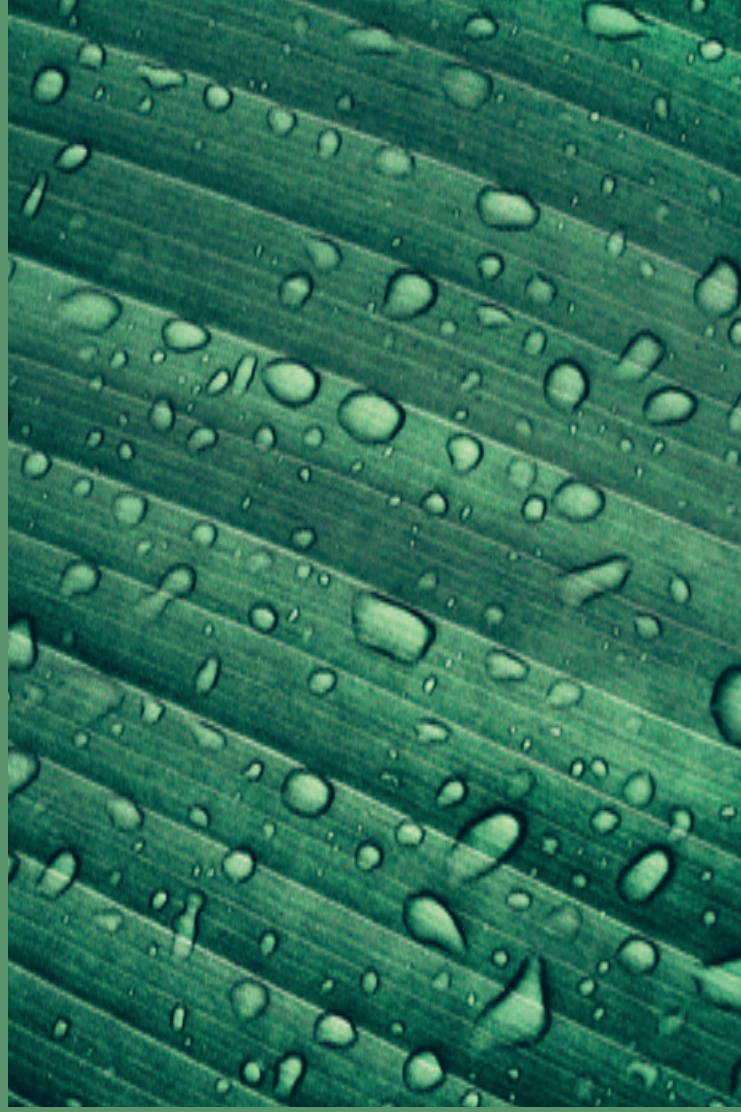

SAMO utilizza al 100% energia da fonti rinnovabili. Un impegno costante nel tempo.

Le Garanzie d'Origine GO sono dei certificati internazionali che vengono riconosciuti a quegli impianti di produzione di energia elettrica che rispettano determinate caratteristiche di sostenibilità ambientale. Nati nel 2009, ad oggi sono lo strumento principale per garantire la tracciabilità dell'energia prodotta e sostengono la promozione e lo sviluppo di un mercato su base volontaria dell'energia pulita prodotta da fonti rinnovabili.

L'obiettivo della certificazione GO è quello di garantire al cliente che una quantità di energia pari a quella da lui consumata sia stata prodotta da impianti alimentati da una fonte rinnovabile ben definita in un determinato periodo di tempo. Mediante l'utilizzo di certificati GO, l'acquirente finanzia l'energia pulita testimoniando il proprio impegno a favore dell'ambiente

Quando l'impegno a favore dell'ambiente e dell'ecosostenibilità delle attività produttive umane facevano i primi vagiti, Samo creò la prima cabina doccia completamente ecologica in collaborazione con Legambiente, realizzata in legno lamellare, alluminio e vetro - materiali riciclabili al 100% - con alcune versioni realizzate con pareti in plastica postconsumo, ovvero in PET riciclato da raccolta differenziata.

Dopo questo primo exploit nel mondo green, l'impegno di Samo si è indirizzato verso il consumo di energia – per

la propria attività produttiva – derivata al 100% da fonti rinnovabili.

Come produttori di docce, l'impegno si è poi esteso – attraverso il progetto "Save water" – verso la promozione di un uso consapevole e responsabile dell'acqua, in primo luogo promuovendo quei comportamenti quotidiani che consentano un utilizzo corretto e senza sprechi del bene "acqua", fonte primaria della vita.

A questo impegno fa eco la certificazione CO₂ della produzione delle docce, e la compensazione dell'impatto nell'ambiente di diossido di carbonio di tutte le attività di marketing del marchio Samo, attraverso l'acquisto di Carbon Credits.

L'impegno a favore dell'ambiente è un cammino che Samo desidera percorrere da protagonista, con la consapevolezza che non ci si può mai sentire "abbastanza" soddisfatti dei propri passi e dei propri comportamenti, a favore di un'economia realmente sostenibile dal nostro amato pianeta.

Siamo responsabili



Materiali plastici da recupero e facilmente riutilizzabili

La vita all'aria aperta è un miraggio per molti, ma anche una realtà per tutti coloro che cercano un contatto con il mondo fuori dalle mura domestiche.

Istà è la doccia disegnata da Joe Velluto proposta da Samo per un pubblico legato all'outdoor. L'estate ci porta a vivere momenti spensierati alla luce del sole e nulla è più desiderato che una doccia rinfrescante dopo una splendida e calda giornata estiva.

Istà si presenta con un design lineare e semplice, che le permette di adattarsi a tutti gli ambienti esterni, senza alterare l'equilibrio di stili e materiali.



Istà

H 236 cm.

Finitura base

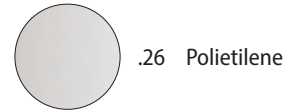

Finitura struttura in metallo



236
cm

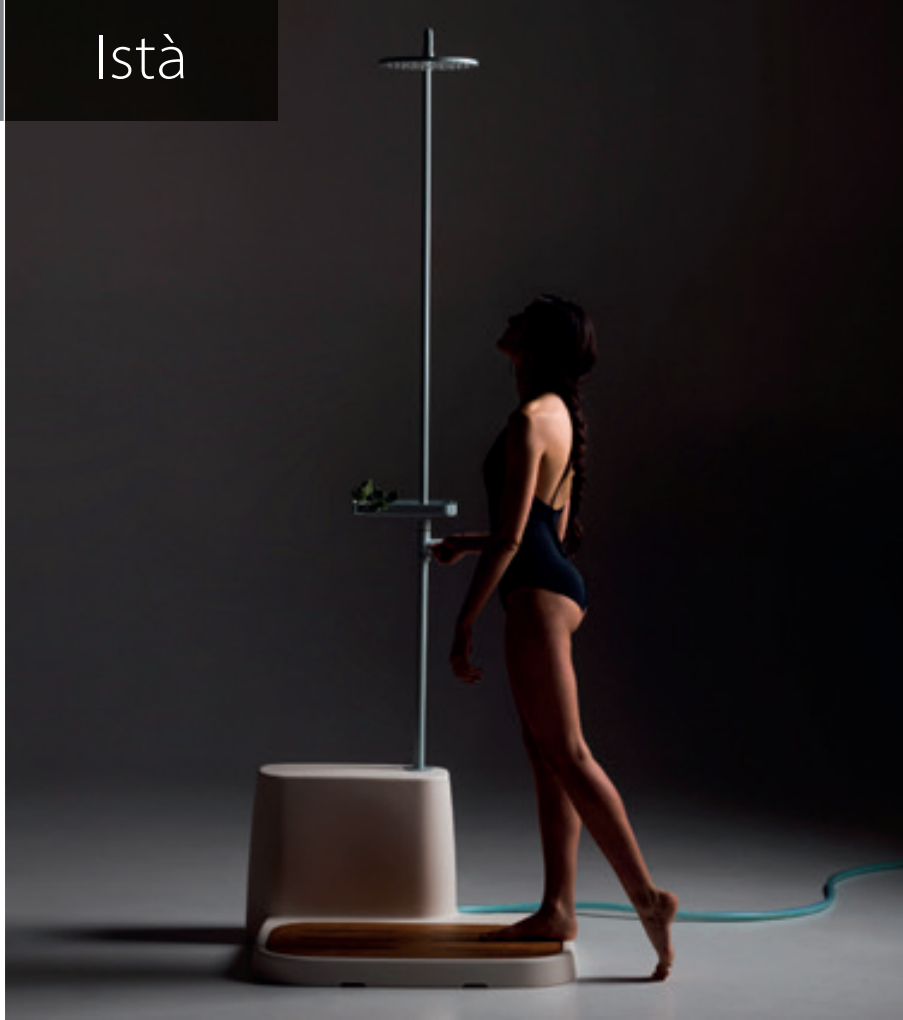

Doccia da esterni mobile con base in polietilene, staffa e soffione in metallo verniciato a polveri.
Designer: Studio JoeVelluto



Doccia da esterni

Z [cm]	Cod.	A [cm]	B [cm]	B1 [cm]	[dm ³]	[kg]	[n°]	.20 [€]
87x87	53830.09	236	45,5	//	//	//	1	**

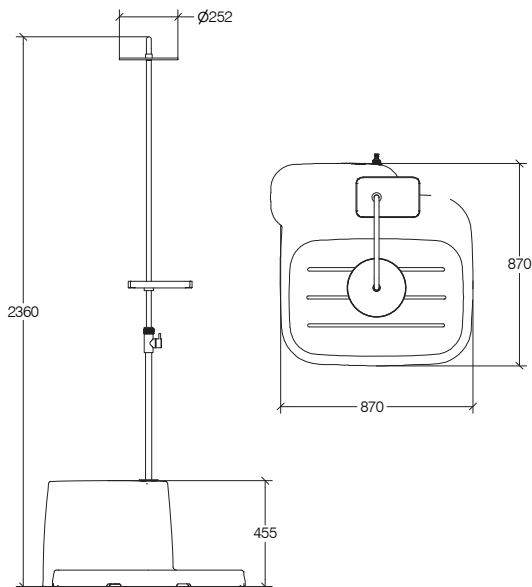
** Vedi catalistino Lineabeta

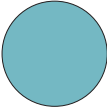

Finitura base



-  .76 Azzurro
-  .95 Grigio
-  .99 Tortora

Il lavabo può essere installato a parete (indoor) con relativo kit da acquistare separatamente cod. A53565K1, o in appoggio (outdoor) con apposito kit da acquistare separatamente cod. A53565K2.
Il rubinetto non è incluso nell'imballo.



Lavabo in materiale plastico riciclato,
Designer: Studio JoeVelluto

Lavabo outdoor e/o indoor

	Cod.	A [cm]	H [cm]	P [cm]	 [dm ³]	 [kg]	 [n°]	.76 - .95 - .99 [€]
//	53565.	70	85	40	238	18	1	**

** Vedi catalistino Lineabeta



Pyxis









B1748AL4TR



B1785SNKTR_B1795SNKTR

PLUS DI PRODOTTO



- H 200 cm
- Pannelli in vetro temperato 6 mm per porte scorrevoli e pareti fisse
- Pannelli in vetro temperato 8 mm per porte battenti
- Struttura in alluminio
 - _ profili orizzontali H.1,5 cm
 - _ profili verticali a muro H. 3 cm
- Assenza di profilo inferiore su porta scorrevole 2 ante e parete fissa ad angolo dedicata
- Cerniere pivot e cuscinetti incollati con tecnologia UV (facilità di pulizia e impatto estetico)
- Profilo magnetico di chiusura in alluminio su porte scorrevoli
- Profilo magnetico di chiusura in alluminio bilaterale a scomparsa a triplo magnete su porte battenti
- Trattamento anticalcare StarClean di serie incluso nel prezzo

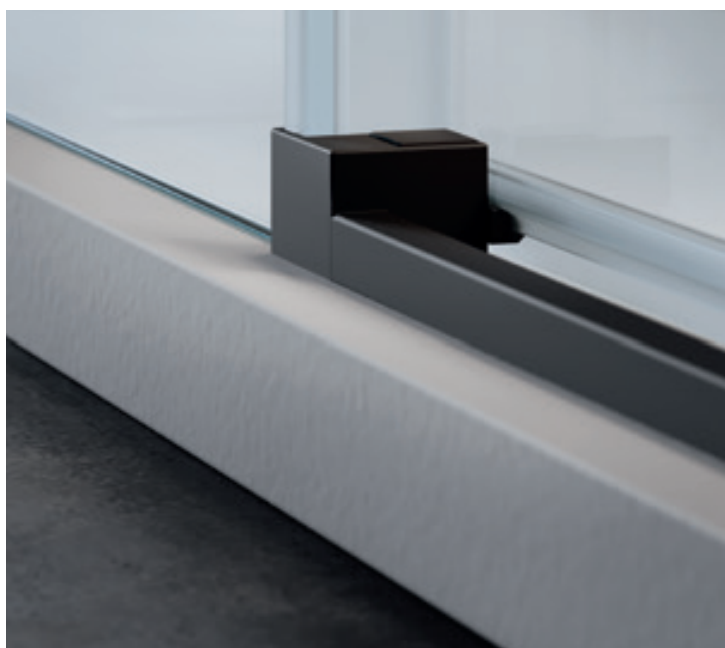



Stampa digitale
disponibile su tutti vetri piani TR e TG

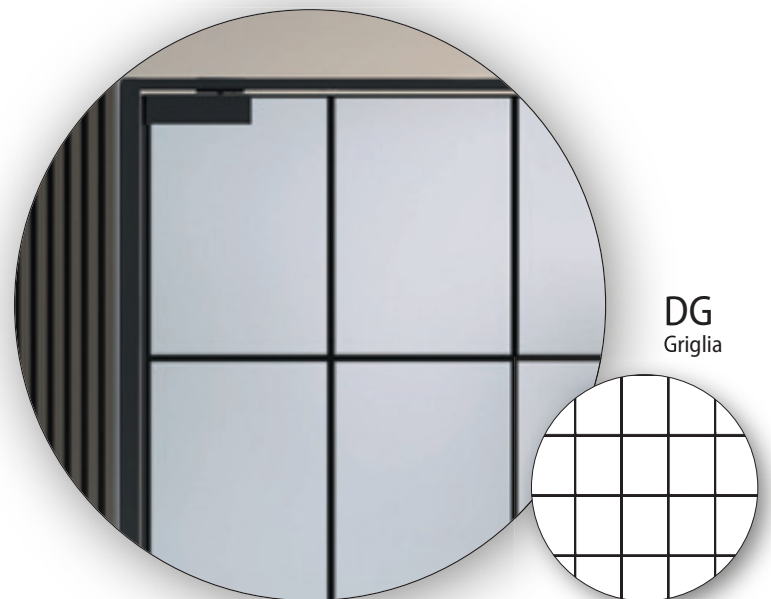
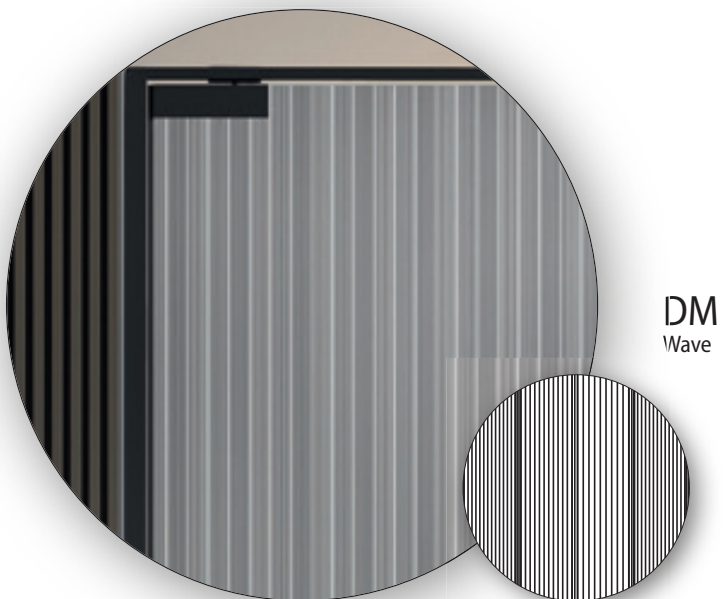
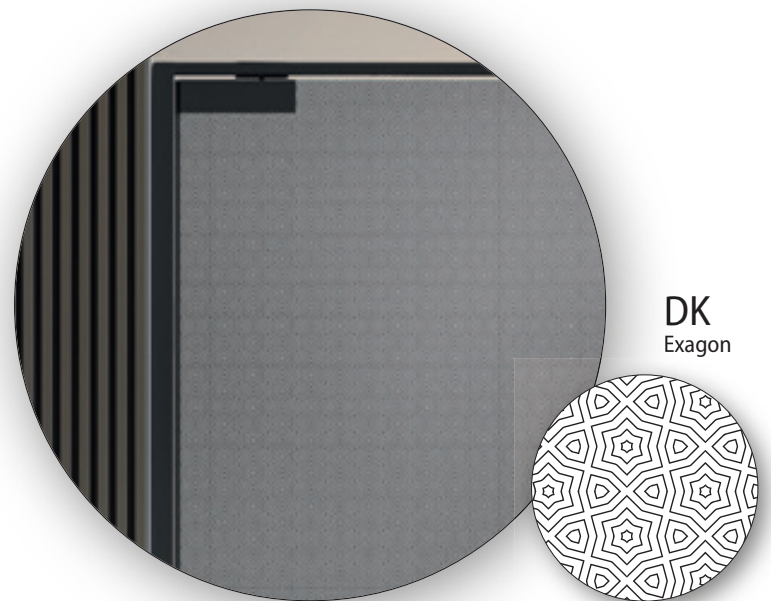
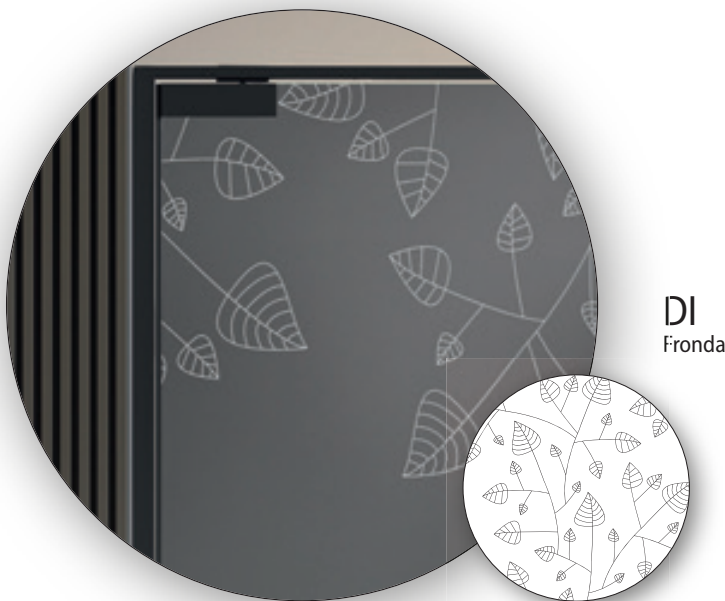
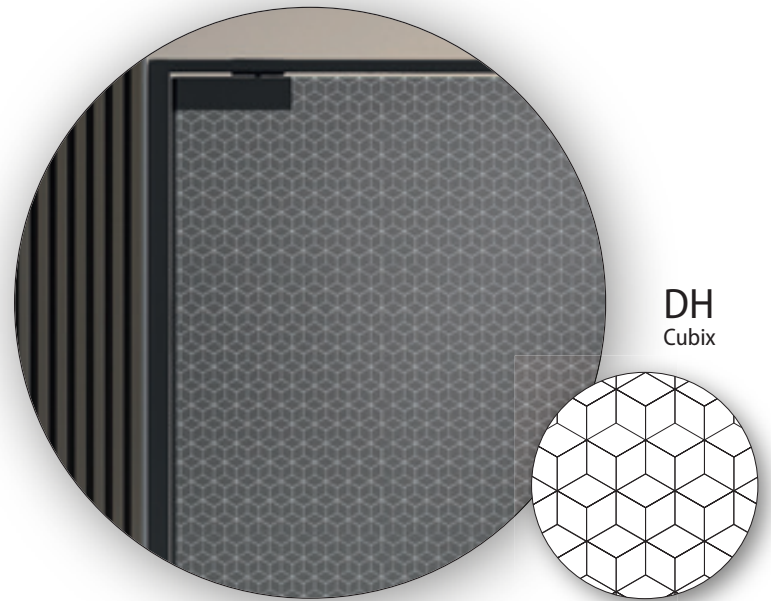
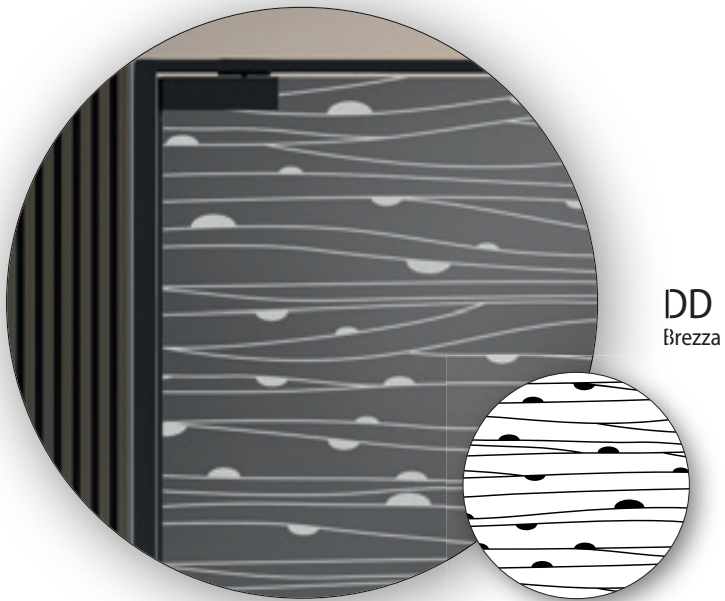

Pyxis

Stampa
digitale



DN
Rombi

Pyxis



Finitura pannelli

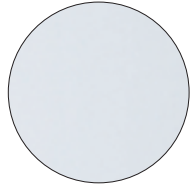

TR
Trasparente

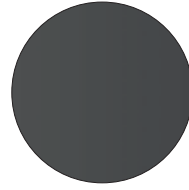

TG
Trasparente Grigio

Profili in alluminio



ULU
Brillantato cromo

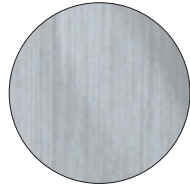

SNK
Nickel spazzolato opaco

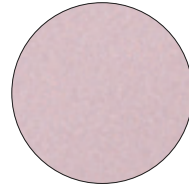

L55
Rosa metallizzato opaco

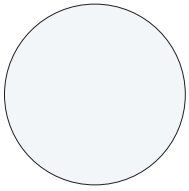

L91
Bianco opaco

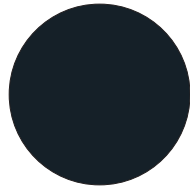

L96
Nero opaco

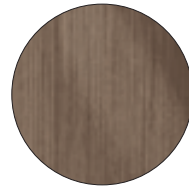

AL4
Bronzo spazzolato opaco

Angolo



In arrivo

Porte per nicchia

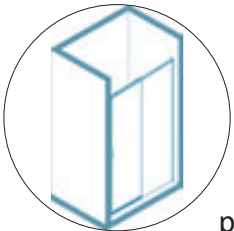

p. 36

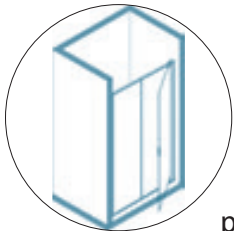

p. 40

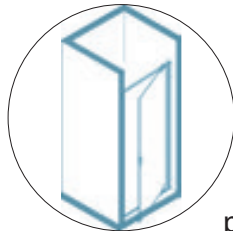

p. 44

Porte per angolo con parete fissa dedicata

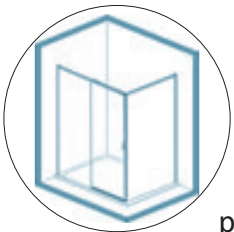

p. 38

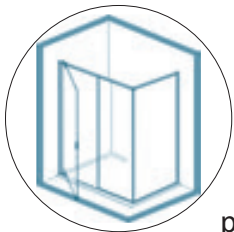

p. 42

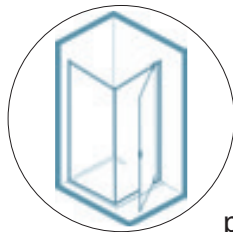

p. 46

5
anni di
GARANZIA

200
cm

6
mm



UV
TECH



Finitura pannelli

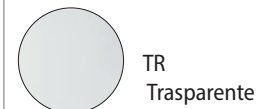

Profili in alluminio

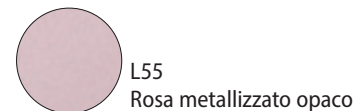
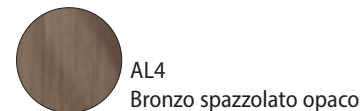
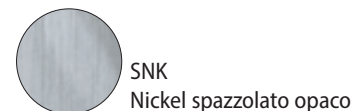
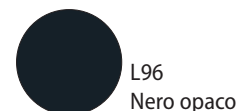

Porta scorrevole a due ante. Apertura laterale ad anta scorrevole, una fissa ed una apribile.
Profili superiori e verticali portanti, assenza di quelli inferiori. Sgancio rapido dell'anta per agevolare la pulizia.





SX

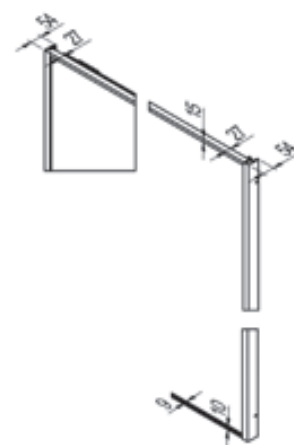

DX



Le dimensioni sono espresse in mm.

Z [cm]	Cod.	A [cm]	B [cm]	C [cm]	 [dm³]	 [kg]	 [n°]	Pannelli	ULU [€]	L91-L96 [€]	L55 [€]	SNK-AL4 [€]
96,5-98,5	B1770	48	48	40	184	36	2	TR	930	930	930	1209
								TG	1070	1070	1070	1391
98,5-100,5	B1771	50	48	40	187	37	2	TR	930	930	930	1209
								TG	1070	1070	1070	1391
106,5-108,5	B1772	53	53	45	203	40	2	TR	970	970	970	1261
								TG	1116	1116	1116	1451
108,5-110,5	B1773	55	53	45	206	41	2	TR	970	970	970	1261
								TG	1116	1116	1116	1451
116,5-118,5	B1774	58	58	50	222	44	2	TR	1000	1000	1000	1300
								TG	1150	1150	1150	1495
118,5-120,5	B1775	60	58	50	226	44	2	TR	1000	1000	1000	1300
								TG	1150	1150	1150	1495
136,5-138,5	B1776	68	68	60	260	51	2	TR	1080	1080	1080	1404
								TG	1242	1242	1242	1615
138,5-140,5	B1777	70	68	60	264	52	2	TR	1080	1080	1080	1404
								TG	1242	1242	1242	1615
156,5-158,5	B1778	78	78	70	298	59	2	TR	1180	1180	1180	1534
								TG	1357	1357	1357	1765
158,5-160,5	B1779	80	78	70	302	59	2	TR	1180	1180	1180	1534
								TG	1357	1357	1357	1765

Tempi di consegna

1-2 settimane

2-3 settimane

3-4 settimane

Prodotti Speciali	Misure limite	I [€]	II [€]	III [€]
		H max 200 cm - min 150 cm / L max 158,5 cm - min 80 cm	135	185

Modulo di richiesta disponibile on-line sul sito: www.samo.it/it/prodotti-speciali - In caso di annullamento dopo l'accettazione, sarà addebitato il costo totale dell'ordine.



Inquadrare il QR code per collegarsi alla pagina del sito www.samo.it per vedere altre combinazioni di pannelli e vetri



Trattamento anticalcare di serie compreso nel prezzo

5
anni di
GARANZIA

200
cm

6
mm



Finitura pannelli

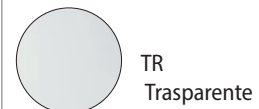

TR
Trasparente



TG
Trasparente grigio

Profili in alluminio



ULU
Brillantato cromo

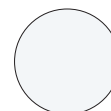

L91
Bianco opaco



L96
Nero opaco

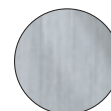

SNK
Nickel spazzolato opaco



AL4
Bronzo spazzolato opaco

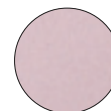

L55
Rosa metallizzato opaco

Porta scorrevole a due ante. Apertura laterale ad anta scorrevole, una fissa ed una apribile.
Profili superiori e verticali portanti, assenza di quelli inferiori, anche su parete fissa per angolo.
Sgancio rapido dell'anta per agevolare la pulizia.



DX

SX



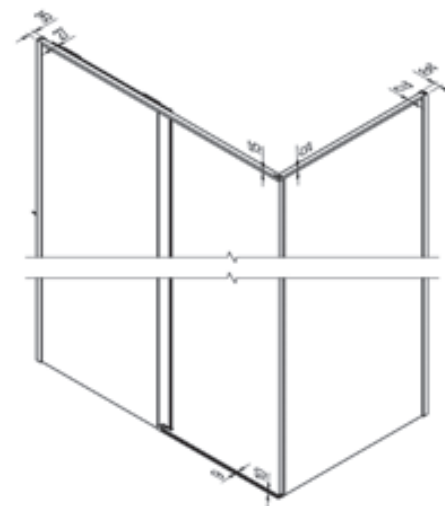
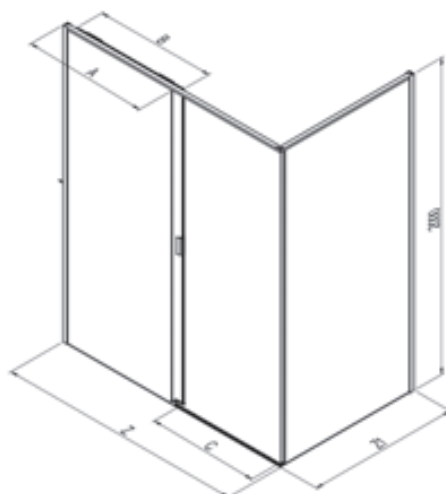

SX

DX



Le dimensioni sono espresse in mm.

Z [cm]	Cod.	A [cm]	B [cm]	C [cm]	 [dm³]	 [kg]	 [n°]	Pannelli	ULU [€]	L91-L96 [€]	L55 [€]	SNK-AL4 [€]
97,5-98,5	B1780	50	48	40	184	36	2	TR	880	880	880	1144
								TG	1012	1012	1012	1316
98,5-99,5	B1781	50	48	40	186	36	2	TR	880	880	880	1144
								TG	1012	1012	1012	1316
107,5-108,5	B1782	55	53	45	203	40	2	TR	920	920	920	1196
								TG	1058	1058	1058	1376
108,5-109,5	B1783	55	53	45	205	40	2	TR	920	920	920	1196
								TG	1058	1058	1058	1376
117,5-118,5	B1784	60	58	50	222	44	2	TR	950	950	950	1235
								TG	1093	1093	1093	1421
118,5-119,5	B1785	60	58	50	224	44	2	TR	950	950	950	1235
								TG	1093	1093	1093	1421
137,5-138,5	B1786	70	68	60	260	51	2	TR	1030	1030	1030	1339
								TG	1185	1185	1185	1540
138,5-139,5	B1787	70	68	60	262	51	2	TR	1030	1030	1030	1339
								TG	1185	1185	1185	1540
157,5-158,5	B1788	80	78	70	298	58	2	TR	1120	1120	1120	1456
								TG	1288	1288	1288	1675
158,5-159,5	B1789	80	78	70	300	59	2	TR	1120	1120	1120	1456
								TG	1288	1288	1288	1675

Z1 [cm]	Parete fissa per angolo dedicata solo per porta scorrevole 							H 200 cm. - V 6 mm.				
67,5-68,5	B1790	//	//	//	121	24	1	TR	380	380	380	494
								TG	437	437	437	569
68,5-69,5	B1791	//	//	//	123	24	1	TR	380	380	380	494
								TG	437	437	437	569
72,5-73,5	B1792	//	//	//	126	26	1	TR	390	390	390	507
								TG	449	449	449	584
73,5-74,5	B1793	//	//	//	128	26	1	TR	390	390	390	507
								TG	449	449	449	584
77,5-78,5	B1794	//	//	//	130	28	1	TR	400	400	400	520
								TG	460	460	460	598
78,5-79,5	B1795	//	//	//	132	28	1	TR	400	400	400	520
								TG	460	460	460	598
87,5-88,5	B1796	//	//	//	142	31	1	TR	420	420	420	546
								TG	483	483	483	628
88,5-89,5	B1797	//	//	//	144	31	1	TR	420	420	420	546
								TG	483	483	483	628
97,5-98,5	B1798	//	//	//	149	33	1	TR	440	440	440	572
								TG	506	506	506	658
98,5-99,5	B1799	//	//	//	151	33	1	TR	440	440	440	572
								TG	506	506	506	658

Tempi di consegna

1-2 settimane

2-3 settimane

3-4 settimane

Prodotti Speciali	Misure limite	I [€]	II [€]	III [€]
Porta scorrevole	H max 200 cm - min 150 cm / L max 158,5 cm - min 80 cm	135	185	200
Parete fissa	H max 200 cm - min 150 cm / L max 140 cm - min 30 cm	70	90	105

Modulo di richiesta disponibile on-line sul sito: www.samo.it/it/prodotti-speciali - In caso di annullamento dopo l'accettazione, sarà addebitato il costo totale dell'ordine.



Inquadrare il QR code per collegarsi alla pagina del sito www.samo.it per vedere altre combinazioni di pannelli e vetri



Trattamento anticalcare di serie compreso nel prezzo

5
anni di
GARANZIA

200
cm

8
mm

6
mm



Finitura pannelli

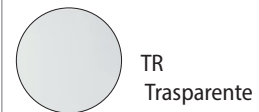

TR
Trasparente



TG
Trasparente grigio

Profili in alluminio



ULU
Brillantato cromo

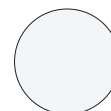

L91
Bianco opaco



L96
Nero opaco

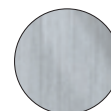

SNK
Nickel spazzolato opaco



AL4
Bronzo spazzolato opaco

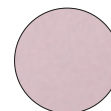

L55
Rosa metallizzato opaco

Porta ad un'anta a battente pivotante (8 mm.) con parete fissa in linea (6 mm.). Apertura verso l'interno e l'esterno.





SX

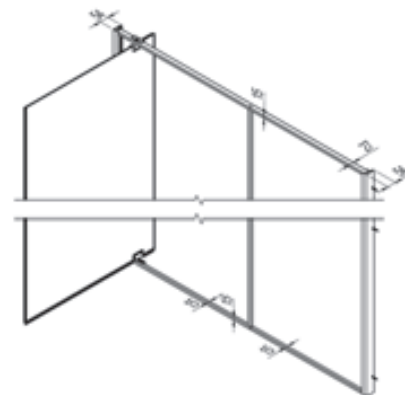
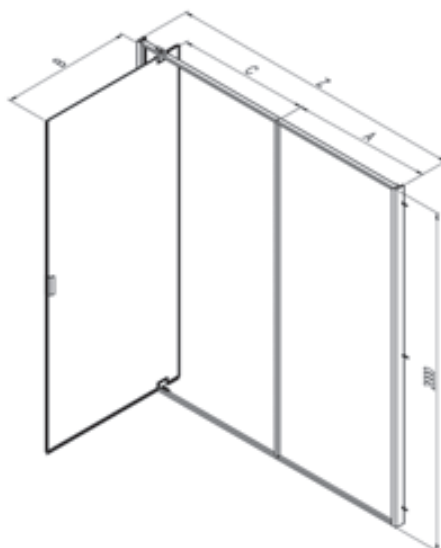

DX



Le dimensioni sono espresse in mm.

Z [cm]	Cod.	A [cm]	B [cm]	C [cm]	 [dm³]	 [kg]	 [n°]	Pannelli	ULU [€]	L91-L96 [€]	L55 [€]	SNK-AL4 [€]
97-99	B1740	33	47	48	184	36	2	TR	1360	1360	1360	1768
								TG	1564	1564	1564	2034
99-101	B1741	33	49	50	188	37	2	TR	1360	1360	1360	1768
								TG	1564	1564	1564	2034
117-119	B1742	33	67	68	222	44	2	TR	1420	1420	1420	1846
								TG	1633	1633	1633	2123
119-121	B1743	33	69	70	226	44	2	TR	1420	1420	1420	1846
								TG	1633	1633	1633	2123
137-139	B1744	53	67	68	260	51	2	TR	1450	1450	1450	1885
								TG	1668	1668	1668	2168
139-141	B1745	53	69	70	264	52	2	TR	1450	1450	1450	1885
								TG	1668	1668	1668	2168
157-159	B1746	73	67	68	298	58	2	TR	1500	1500	1500	1950
								TG	1725	1725	1725	2243
159-161	B1747	73	69	70	302	59	2	TR	1500	1500	1500	1950
								TG	1725	1725	1725	2243
177-179	B1748	83	77	78	336	66	2	TR	1530	1530	1530	1989
								TG	1760	1760	1760	2288
179-181	B1749	83	79	80	340	67	2	TR	1530	1530	1530	1989
								TG	1760	1760	1760	2288

Tempi di consegna

1-2 settimane

2-3 settimane

3-4 settimane

Prodotti Speciali

Misure limite

I [€]

II [€]

III [€]

H max 200 cm - min 150 cm / L max 200 cm - min 90 cm

135

155

185

Modulo di richiesta disponibile on-line sul sito: www.samo.it/it/prodotti-speciali - In caso di annullamento dopo l'accettazione, sarà addebitato il costo totale dell'ordine.



Inquadrare il QR code per collegarsi alla pagina del sito www.samo.it per vedere altre combinazioni di pannelli e vetri



Trattamento anticalcare di serie compreso nel prezzo

5
anni di
GARANZIA

200
cm

8
mm

6
mm



Finitura pannelli

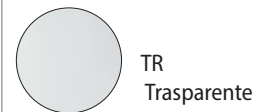

TR
Trasparente



TG
Trasparente grigio

Profili in alluminio



ULU
Brillantato cromo

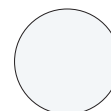

L91
Bianco opaco



L96
Nero opaco

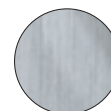

SNK
Nickel spazzolato opaco



AL4
Bronzo spazzolato opaco

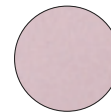

L55
Rosa metallizzato opaco

Porta ad un'anta a battente pivotante (8 mm.) con parete fissa in linea (6 mm.). Apertura verso l'interno e l'esterno.





SX

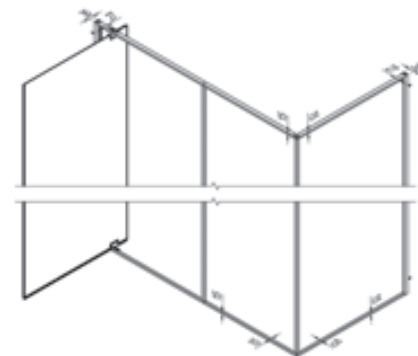
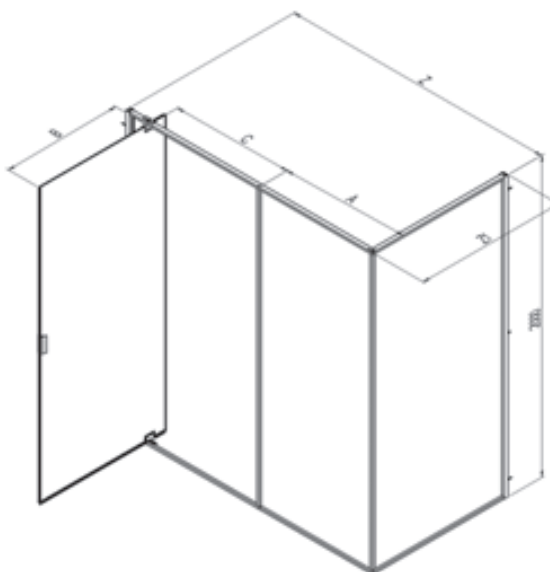

DX



Le dimensioni sono espresse in mm.

Z [cm]	Cod.	A [cm]	B [cm]	C [cm]	 [dm ³]	 [kg]	 [n°]	Pannelli	ULU [€]	L91-L96 [€]	L55 [€]	SNK-AL4 [€]
97-98	B1750	34	47	48	184	36	2	TR	1300	1300	1300	1690
								TG	1495	1495	1495	1944
98-99	B1751	34	48	49	186	36	2	TR	1300	1300	1300	1690
								TG	1495	1495	1495	1944
117-118	B1752	34	67	68	222	44	2	TR	1350	1350	1350	1755
								TG	1553	1553	1553	2019
118-119	B1753	34	68	69	224	44	2	TR	1350	1350	1350	1755
								TG	1553	1553	1553	2019
137-138	B1754	54	67	68	260	51	2	TR	1390	1390	1390	1807
								TG	1599	1599	1599	2079
138-139	B1755	54	68	69	262	51	2	TR	1390	1390	1390	1807
								TG	1599	1599	1599	2079
157-158	B1756	74	67	68	298	58	2	TR	1430	1430	1430	1859
								TG	1645	1645	1645	2138
158-159	B1757	74	68	69	300	59	2	TR	1430	1430	1430	1859
								TG	1645	1645	1645	2138
177-178	B1758	84	77	78	336	66	2	TR	1460	1460	1460	1898
								TG	1679	1679	1679	2183
178-179	B1759	84	78	79	338	66	2	TR	1460	1460	1460	1898
								TG	1679	1679	1679	2183

Z1 [cm]	Parete fissa per angolo solo per porta battente con fissa in linea 							H 200 cm. - V 6 mm.				
67-68	B1760	//	//	//	121	24	1	TR	380	380	380	494
								TG	437	437	437	569
68-69	B1761	//	//	//	123	24	1	TR	380	380	380	494
								TG	437	437	437	569
72-73	B1762	//	//	//	126	26	1	TR	390	390	390	507
								TG	449	449	449	584
73-74	B1763	//	//	//	128	26	1	TR	390	390	390	507
								TG	449	449	449	584
77-78	B1764	//	//	//	130	28	1	TR	400	400	400	520
								TG	460	460	460	598
78-79	B1765	//	//	//	132	28	1	TR	400	400	400	520
								TG	460	460	460	598
87-88	B1766	//	//	//	142	31	1	TR	420	420	420	546
								TG	483	483	483	628
88-89	B1767	//	//	//	144	31	1	TR	420	420	420	546
								TG	483	483	483	628
97-98	B1768	//	//	//	149	33	1	TR	440	440	440	572
								TG	506	506	506	658
98-99	B1769	//	//	//	151	33	1	TR	440	440	440	572
								TG	506	506	506	658

Tempi di consegna

1-2 settimane

2-3 settimane

3-4 settimane

Prodotti Speciali	Misure limite	I [€]	II [€]	III [€]
Porta battente con fissa in linea	H max 200 cm - min 150 cm / L max 200 cm - min 90 cm	135	155	185
Parete fissa	H max 200 cm - min 150 cm / L max 140 cm - min 30 cm	70	90	105

Modulo di richiesta disponibile on-line sul sito: www.samo.it/it/prodotti-speciali - In caso di annullamento dopo l'accettazione, sarà addebitato il costo totale dell'ordine.



Inquadrare il QR code per collegarsi alla pagina del sito www.samo.it per vedere altre combinazioni di pannelli e vetri



Tattamento anticallcare di serie compreso nel prezzo

5
anni di
GARANZIA

200
cm

8
mm



Finitura pannelli

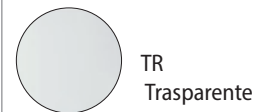

TR
Trasparente



TG
Trasparente grigio

Profili in alluminio



ULU
Brillantato cromo



L91
Bianco opaco

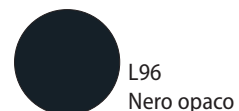

L96
Nero opaco

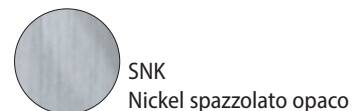

SNK
Nickel spazzolato opaco

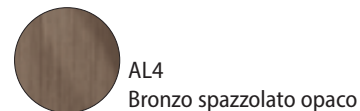

AL4
Bronzo spazzolato opaco

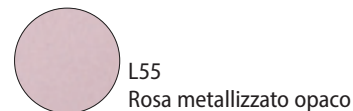

L55
Rosa metallizzato opaco

Porta ad un'anta a battente pivotante con apertura verso l'interno e l'esterno.





SX

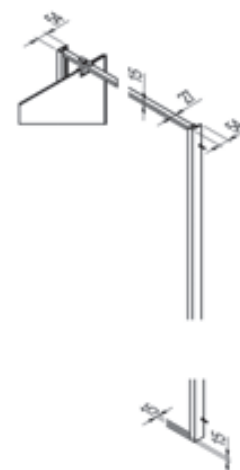

DX



Le dimensioni sono espresse in mm.

Z [cm]	Cod.	A [cm]	B [cm]	C [cm]	 [dm³]	 [kg]	 [n°]	Pannelli	ULU [€]	L91-L96 [€]	L55 [€]	SNK-AL4 [€]
67-69	B1700	//	47	48	117	24	1	TR	1090	1090	1090	1417
								TG	1254	1254	1254	1630
69-71	B1701	//	49	50	120	25	1	TR	1090	1090	1090	1417
								TG	1254	1254	1254	1630
72-74	B1702	//	52	53	131	27	1	TR	1110	1110	1110	1443
								TG	1277	1277	1277	1660
74-76	B1703	//	54	55	135	28	1	TR	1110	1110	1110	1443
								TG	1277	1277	1277	1660
77-79	B1704	//	57	58	148	30	1	TR	1120	1120	1120	1456
								TG	1288	1288	1288	1675
79-81	B1705	//	59	60	152	31	1	TR	1120	1120	1120	1456
								TG	1288	1288	1288	1675
87-89	B1706	//	67	68	163	33	1	TR	1140	1140	1140	1482
								TG	1311	1311	1311	1705
89-91	B1707	//	69	70	167	34	1	TR	1140	1140	1140	1482
								TG	1311	1311	1311	1705
97-99	B1708	//	77	78	175	35	1	TR	1180	1180	1180	1534
								TG	1357	1357	1357	1765
99-101	B1709	//	79	80	179	36	1	TR	1180	1180	1180	1534
								TG	1357	1357	1357	1765

Tempi di consegna	1-2 settimane	2-3 settimane	3-4 settimane
-------------------	---------------	---------------	---------------

Prodotti Speciali	Misure limite	I [€]	II [€]	III [€]
	H max 200 cm - min 150 cm / L max 99 cm - min 60 cm	115	135	150

Modulo di richiesta disponibile on-line sul sito: www.samo.it/it/prodotti-speciali - In caso di annullamento dopo l'accettazione, sarà addebitato il costo totale dell'ordine.



Inquadrare il QR code per collegarsi alla pagina del sito www.samo.it per vedere altre combinazioni di pannelli e vetri



Trattamento anticalcare di serie compreso nel prezzo

5
anni di
GARANZIA

200
cm

8
mm

6
mm



Finitura pannelli

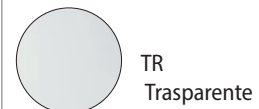

TR
Trasparente



TG
Trasparente grigio

Profili in alluminio



ULU
Brillantato cromo

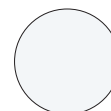

L91
Bianco opaco



L96
Nero opaco

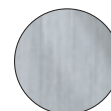

SNK
Nickel spazzolato opaco



AL4
Bronzo spazzolato opaco

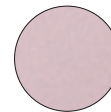

L55
Rosa metallizzato opaco

Porta ad un'anta a battente pivotante con apertura verso l'interno e l'esterno.





SX

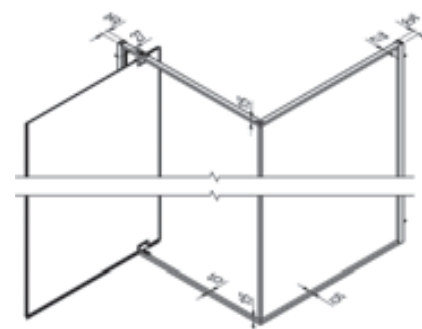
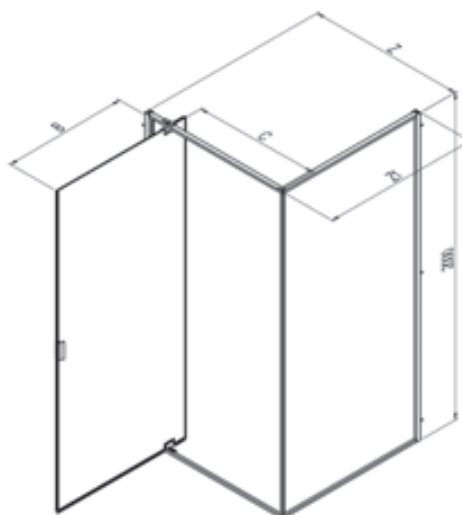

DX



Le dimensioni sono espresse in mm.

Z [cm]	Cod.	B [cm]	C [cm]	 [dm ³]	 [kg]	 [n°]	Pannelli	ULU [€]	L91-L96 [€]	L55 [€]	SNK-AL4 [€]
67-68	B1720	47	48	117	24	1	TR	1040	1040	1040	1352
							TG	1196	1196	1196	1555
68-69	B1721	48	49	119	24	1	TR	1040	1040	1040	1352
							TG	1196	1196	1196	1555
72-73	B1722	52	53	131	27	1	TR	1060	1060	1060	1378
							TG	1219	1219	1219	1585
73-74	B1723	53	54	133	27	1	TR	1060	1060	1060	1378
							TG	1219	1219	1219	1585
77-78	B1724	57	58	148	30	1	TR	1070	1070	1070	1391
							TG	1231	1231	1231	1600
78-79	B1725	58	59	150	30	1	TR	1070	1070	1070	1391
							TG	1231	1231	1231	1600
87-88	B1726	67	68	163	33	1	TR	1090	1090	1090	1417
							TG	1254	1254	1254	1630
88-89	B1727	68	69	165	33	1	TR	1090	1090	1090	1417
							TG	1254	1254	1254	1630
97-98	B1728	77	78	175	35	1	TR	1130	1130	1130	1469
							TG	1300	1300	1300	1690
98-99	B1729	78	79	177	35	1	TR	1130	1130	1130	1469
							TG	1300	1300	1300	1690

Z1 [cm]	Parete fissa per angolo solo per porta battente pivotante 						H 200 cm. - V 6 mm.				
67-68	B1730	//	//	121	24	1	TR	380	380	380	494
							TG	437	437	437	569
68-69	B1731	//	//	123	24	1	TR	380	380	380	494
							TG	437	437	437	569
72-73	B1732	//	//	126	26	1	TR	390	390	390	507
							TG	449	449	449	584
73-74	B1733	//	//	128	26	1	TR	390	390	390	507
							TG	449	449	449	584
77-78	B1734	//	//	130	28	1	TR	400	400	400	520
							TG	460	460	460	598
78-79	B1735	//	//	132	28	1	TR	400	400	400	520
							TG	460	460	460	598
87-88	B1736	//	//	142	31	1	TR	420	420	420	546
							TG	483	483	483	628
88-89	B1737	//	//	144	31	1	TR	420	420	420	546
							TG	483	483	483	628
97-98	B1738	//	//	149	33	1	TR	440	440	440	572
							TG	506	506	506	658
98-99	B1739	//	//	151	33	1	TR	440	440	440	572
							TG	506	506	506	658

Tempi di consegna

1-2 settimane

2-3 settimane

3-4 settimane

Prodotti Speciali	Misure limite	I [€]	II [€]	III [€]
Porta battente	H max 200 cm - min 150 cm / L max 99 cm - min 60 cm	115	135	150
Parete fissa	H max 200 cm - min 150 cm / L max 140 cm - min 30 cm	70	90	105

Modulo di richiesta disponibile on-line sul sito: www.samo.it/it/prodotti-speciali - In caso di annullamento dopo l'accettazione, sarà addebitato il costo totale dell'ordine.



Inquadrare il QR code per collegarsi alla pagina del sito www.samo.it per vedere altre combinazioni di pannelli e vetri



Treatmento anticalcare di serie compreso nel prezzo





Open

libera creatività

Open



Open

B4055L96TG



B4055ULUGS
B4771ULUGS
B4045ULUGS



B4055ULUGS + KTO

Open



B4063L91RF

PLUS DI PRODOTTO

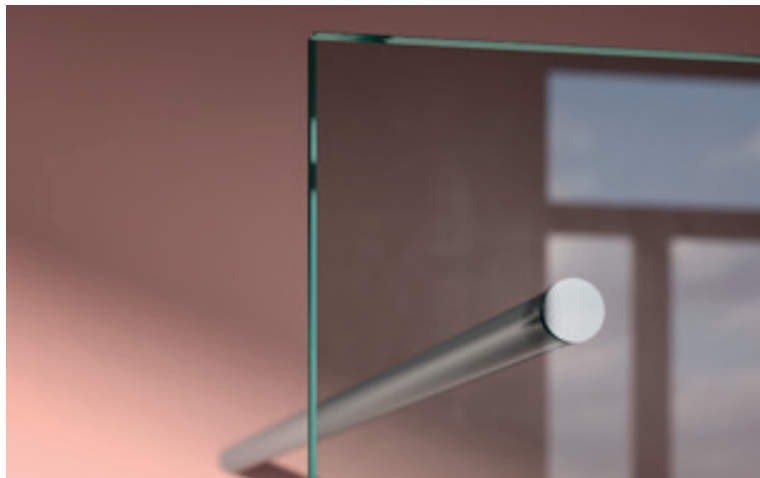

- H 200 cm – V 6/8 mm
- 2 cm di regolazione del fuorisquadra
- Prodotto reversibile
- Profili verticali con fissaggio a pinza (gestione dell'estensibilità nascosta)
- Paretine di combinazione per abbinamenti (solo per 8 mm)
- Porte di chiusura dedicate
- Barre accessorie per diverse configurazioni
- Anticalcare compreso nel prezzo
- Stampa digitale disponibile su tutti i vetri piani TR e TG





Open

Stampa digitale
disponibile su tutti vetri piani TR e TG



DD
Brezza

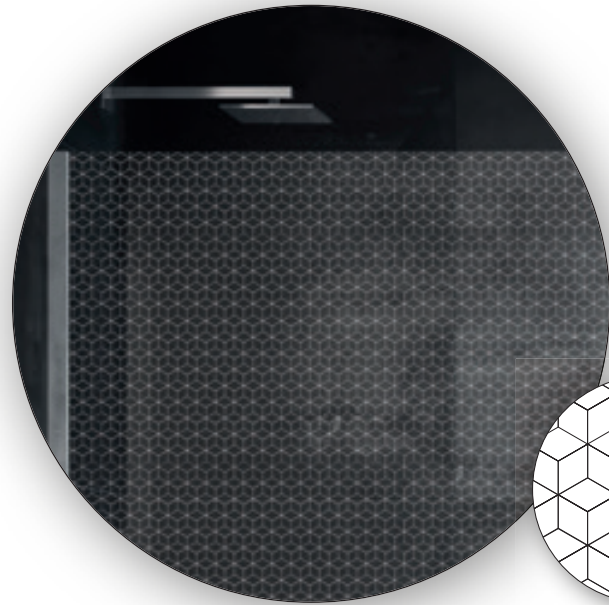
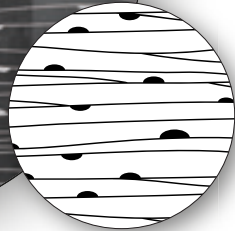

DH
Cubix

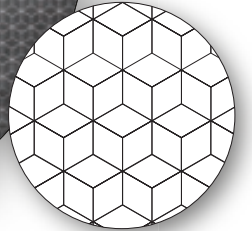

DI
Fronda



DK
Exagon

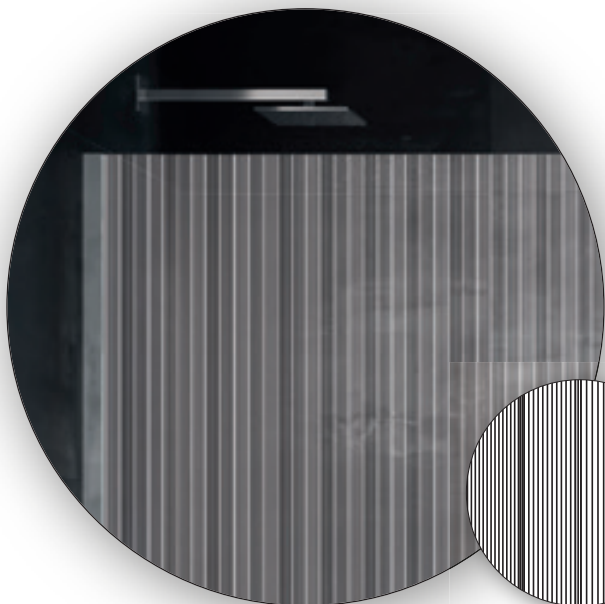

DM
Wave

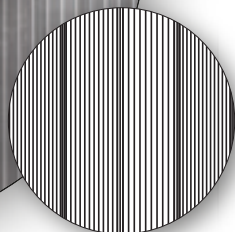

DN
Rombi



Open

Stampa
digitale

Open

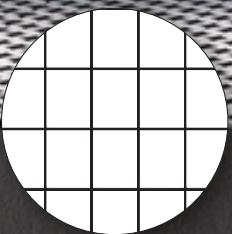

DG
Griglia

Open



Finitura pannelli

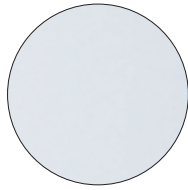

TR
Trasparente

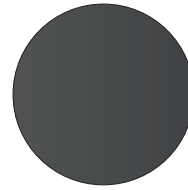

TG
Trasparente grigio

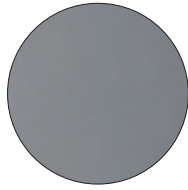

GS
Grigio satinato

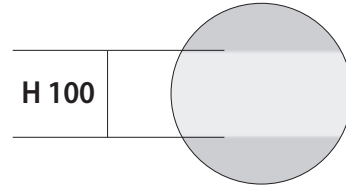

H 100 **RF**
Trasparente con fascia satinata H. 100 cm.

Open

Finitura profili



ULU
Alluminio cromato

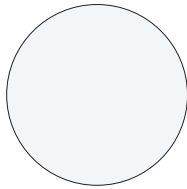

L91
Alluminio bianco opaco

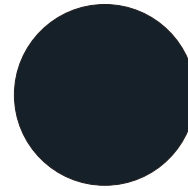

L96
Alluminio nero opaco



NEW **L73**
Alluminio Sage opaco



NEW **L86**
Alluminio Ambra opaco

Open Side

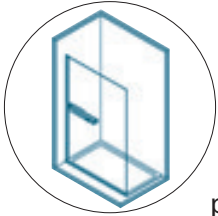

p. 58

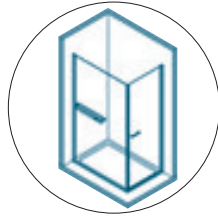

p. 59

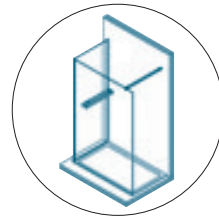

p. 60

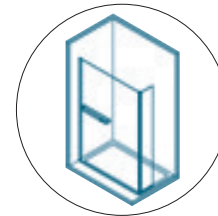

p. 62

Open Side

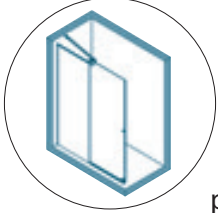

p. 64

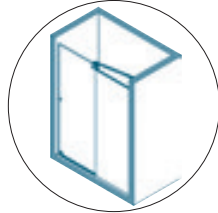

p. 66

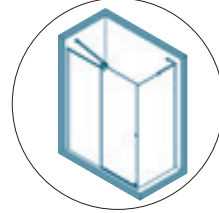

p. 68

Open Side

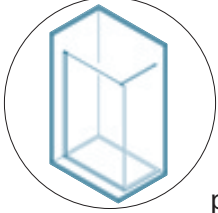

p. 70

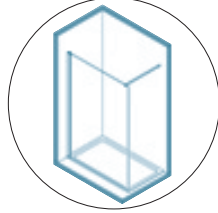

p. 72

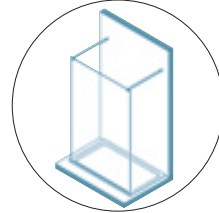

p. 74

Open

5

anni di
GARANZIA

200
cm

8
mm



Finitura pannelli

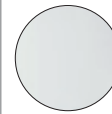

TR
Trasparente



TG
Trasparente grigio

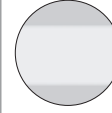

RF
Trasparente con fascia satinata
H 100 cm.



GS
Grigio satinato

Profili in alluminio



ULU
Brillantato cromo

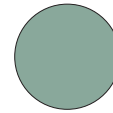

L73
Sage opaco

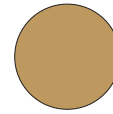

L86
Ambra opaco

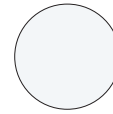





L91
Bianco opaco

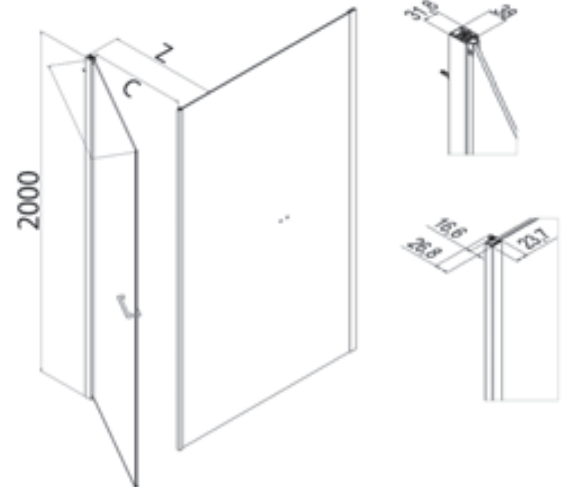
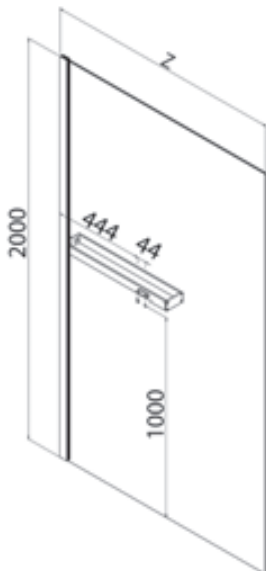

L96
Nero opaco

Cabina doccia spaziosa caratterizzata da area di accesso dedicata e anta fissa con mensola.
Il vano di accesso alla doccia è totalmente libero.
È possibile il montaggio anche senza piatto doccia.



Z [cm]	Cod.	C [cm]	 [dm ³]	 [kg]	 [n°]	Pannelli	ULU [€]	L91 [€]	L96 [€]	L73 - L86 [€]
76-78	B4781		145	34	1	TR	748	748	748	748
						TG	861	861	861	861
78-80	B4751		145	34	1	RF	861	861	861	861
						GS	973	973	973	973
86-88	B4782		165	39	1	TR	828	828	828	828
						TG	953	953	953	953
88-90	B4752		165	39	1	RF	953	953	953	953
						GS	1077	1077	1077	1077
96-98	B4783		183	44	1	TR	828	828	828	828
						TG	953	953	953	953
98-100	B4753		183	44	1	RF	953	953	953	953
						GS	1077	1077	1077	1077
116-118	B4784		201	54	1	TR	891	891	891	891
						TG	1025	1025	1025	1025
118-120	B4754		201	54	1	RF	1025	1025	1025	1025
						GS	1159	1159	1159	1159
136-138	B4785		220	64	1	TR	997	997	997	997
						TG	1147	1147	1147	1147
138-140	B4755		220	64	1	RF	1147	1147	1147	1147
						GS	1297	1297	1297	1297
156-158	B4786		280	75	1	TR	1063	1063	1063	1063
						TG	1223	1223	1223	1223
158-160	B4756		280	75	1	RF	1223	1223	1223	1223
						GS	1382	1382	1382	1382
176-178	B4787		310	83	1	TR	1272	1272	1272	1272
						TG	1463	1463	1463	1463
178-180	B4757		310	83	1	RF	1463	1463	1463	1463
						GS	1654	1654	1654	1654

Porta battente (6 mm.)



H 200 cm. - V 6 mm.

70-85,9	B478X	62-78	107	25	1	TR	603	603	603	603
						TG	694	694	694	694
						RF	694	694	694	694
						GS	784	784	784	784
86-100	B478Y	78-92	120	32	1	TR	652	652	652	652
						TG	750	750	750	750
						RF	750	750	750	750
						GS	848	848	848	848

Tempi di consegna

1-2 settimane

2-3 settimane

3-4 settimane

Prodotti Speciali

Misure limite

I [€]

II [€]

III [€]

Side con mensola

H max 220 cm - min 150 cm / L min 50 cm

120

170

240

Modulo di richiesta disponibile on-line sul sito: www.samo.it/it/prodotti-speciali - In caso di annullamento dopo l'accettazione, sarà addebitato il costo totale dell'ordine.

Trattamento anticalcare di serie compreso nel prezzo



SX



DX

Porta non reversibile, indicare se DX o SX.
Apertura solo verso l'esterno.
Estensibilità = 2 cm.



Inquadrare il QR code per collegarsi alla pagina del sito
www.samo.it per vedere altre combinazioni di pannelli e vetri

Open

5

anni di
GARANZIA

200
cm

8
mm



Finitura pannelli

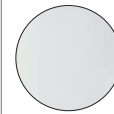

TR
Trasparente



TG
Trasparente grigio

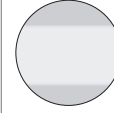

RF
Trasparente con fascia satinata
H 100 cm.

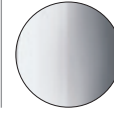

GS
Grigio satinato

Profili in alluminio



ULU
Brillantato cromo



L73
Sage opaco



L86
Ambra opaco



L91
Bianco opaco



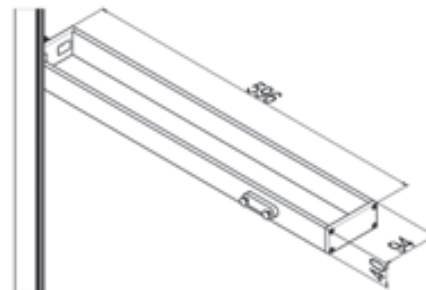
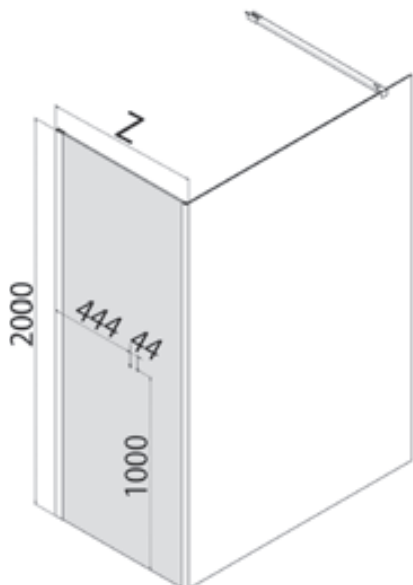

L96
Nero opaco

Parete fissa per abbinamenti, è possibile formare cabine doccia a due lati, anche per misure rettangolari. È possibile il montaggio anche senza piatto doccia.





Le dimensioni sono espresse in mm.

Z [cm]	Cod.	 [dm³]	 [kg]	 [n°]	Pannelli	ULU [€]	L91 [€]	L96 [€]	L73 - L86 [€]
78-80	B4745	116	44	1	TR	673	673	673	673
					TG	774	774	774	774
					RF	774	774	774	774
					GS	875	875	875	875
88-90	B4746	131	49	1	TR	745	745	745	745
					TG	857	857	857	857
					RF	857	857	857	857
					GS	969	969	969	969
88-100	B4747	145	54	1	TR	745	745	745	745
					TG	857	857	857	857
					RF	857	857	857	857
					GS	969	969	969	969

Open

Accessori mensola

Dimensioni [mm]	Cod.	Descrizioni	 [dm³]	 [kg]	 [n°]	Finiture	[€]
85x105x85	5146-S	Porta spazzolini	22	0,100	1	.09 - .18 - .29	46
						.80	39
						.73 - .86	57
130x60x85	5147-S	Portasapone	25	0,120	1	.09 - .18 - .29	46
						.80	39
						.73 - .86	57
205x60x85	5148-S	Portaoggetti	35	0,200	1	.09 - .18 - .29	51
						.80	44
						.73 - .86	61
90x150x85	5152-S	Dosasapone	52	0,250	1	.09 - .18 - .29	71
						.73 - .86	79
290x40x85	5153-S	Mensola d'appoggio	28	0,150	1	.80	40

Tempi di consegna	1-2 settimane	2-3 settimane	3-4 settimane
-------------------	---------------	---------------	---------------

Gli accessori in finitura Sage .73 e Ambra .86 sono ordinabili solo in abbinamento ad almeno una parete doccia, nello stesso colore scelto e con un unico ordine.



Nella composizione degli accessori da inserire nella mensola non superare mai la lunghezza totale di 580 mm

Prodotti Speciali	Misure limite	I [€]	II [€]	III [€]
	H max 220 cm / L max 150 cm - min 60 cm	120	170	240

Modulo di richiesta disponibile on-line sul sito: www.samo.it/it/prodotti-speciali - In caso di annullamento dopo l'accettazione, sarà addebitato il costo totale dell'ordine.



Trattamento anticalcare di serie compreso nel prezzo



Inquadrare il QR code per collegarsi alla pagina del sito www.samo.it per vedere altre combinazioni di pannelli e vetri

Open

5

anni di
GARANZIA

200
cm

8
mm



Finitura pannelli

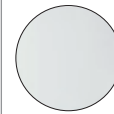

TR
Trasparente



TG
Trasparente grigio

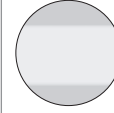

RF
Trasparente con fascia satinata
H 100 cm.

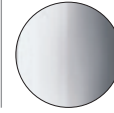

GS
Grigio satinato

Profili in alluminio



ULU
Brillantato cromo



L73
Sage opaco



L86
Ambra opaco



L91
Bianco opaco



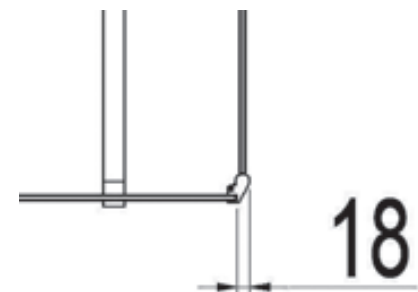
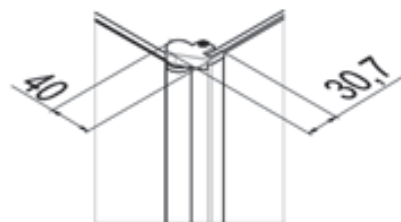
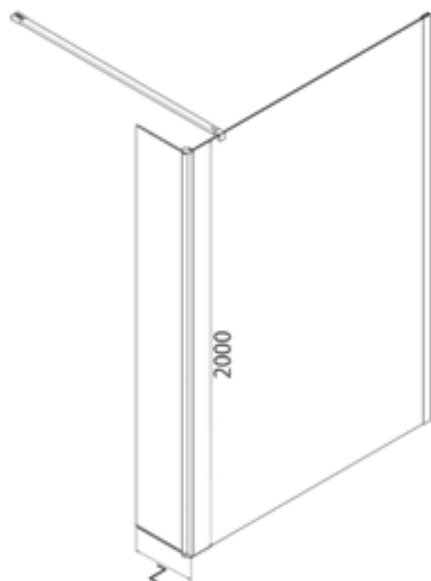

L96
Nero opaco

Deflettore regolabile in svariate angolazioni, dedicato per abbinamento con li modelli della serie Open.
È possibile il montaggio anche senza piatto doccia.



Abbinamento con parete fissa Open Side: aggiungere cm. 1,8 all'estensibilità minima e massima
Le dimensioni sono espresse in mm.

Z [cm]	Cod.	 [dm³]	 [kg]	 [n°]	Pannelli	ULU [€]	L91 [€]	L96 [€]	L73 - L86 [€]
30	B4771	50	35	1	TR	394	394	394	394
					TG	454	454	454	454
					RF	454	454	454	454
					GS	513	513	513	513
40	B4772	50	35	1	TR	419	419	419	419
					TG	482	482	482	482
					RF	482	482	482	482
					GS	545	545	545	545
50	B4773	50	35	1	TR	443	443	443	443
					TG	510	510	510	510
					RF	510	510	510	510
					GS	576	576	576	576

Tempi di consegna	1-2 settimane	2-3 settimane	3-4 settimane
-------------------	---------------	---------------	---------------

Prodotti Speciali	Misure limite	I [€]	II [€]	III [€]
	H max 220 cm / L max 60 cm - min 15 cm	120	170	240

Modulo di richiesta disponibile on-line sul sito: www.samo.it/it/prodotti-speciali - In caso di annullamento dopo l'accettazione, sarà addebitato il costo totale dell'ordine.

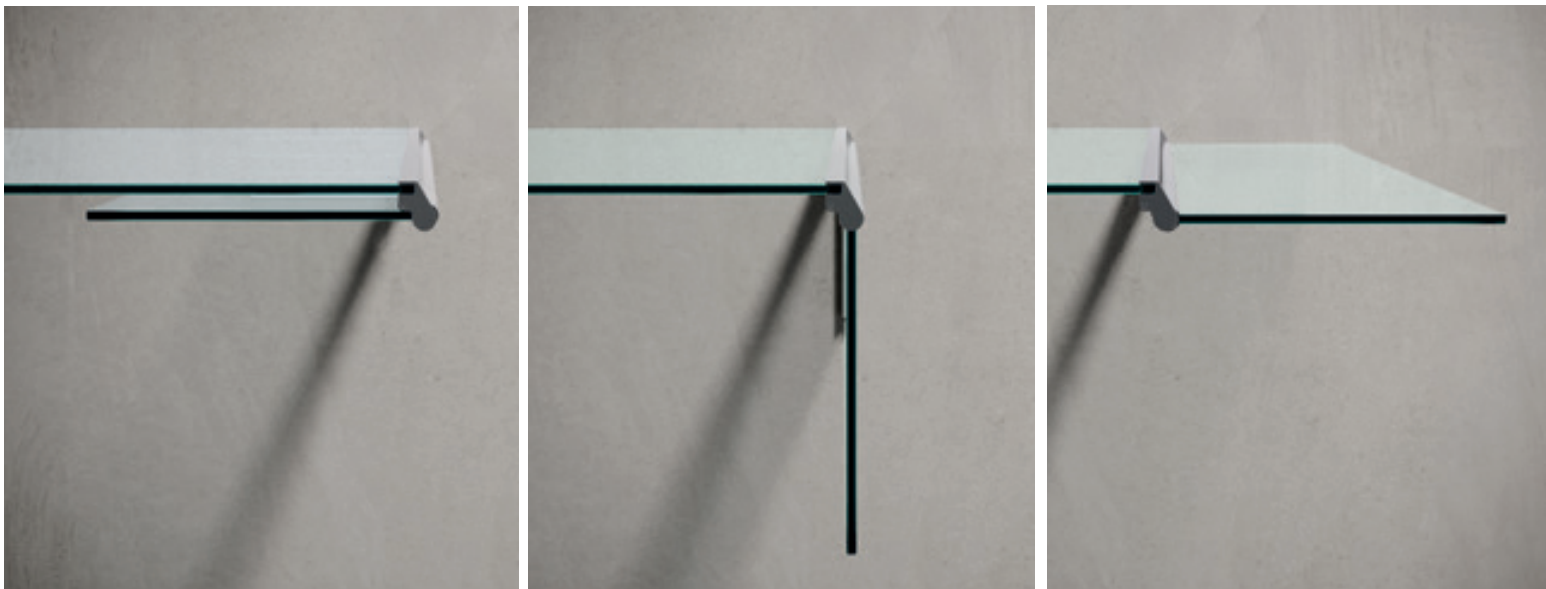

Trattamento anticalcare di serie compreso nel prezzo



Inquadrare il QR code per collegarsi alla pagina del sito www.samo.it per vedere altre combinazioni di pannelli e vetri

5

anni di
GARANZIA

206,5
cm

8
mm

GS-RF



Finitura pannelli

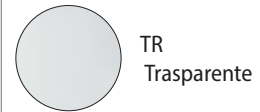

TR
Traslucida



TG
Traslucida grigio

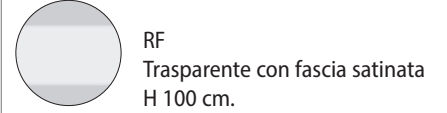

RF
Traslucida con fascia satinata
H 100 cm.



GS
Grigio satinato

Profili in alluminio



ULU
Brillantato cromo

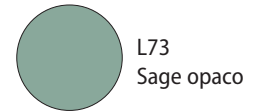

L73
Sage opaco

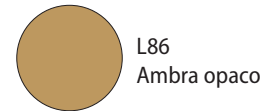

L86
Ambra opaco



L91
Bianco opaco

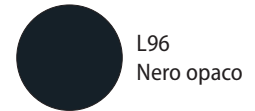

L96
Nero opaco

Cabina doccia spaziosa caratterizzata da area di accesso dedicata e anta fissa e porta scorrevole.
È possibile il montaggio anche senza piatto doccia.

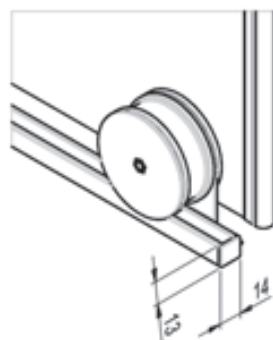
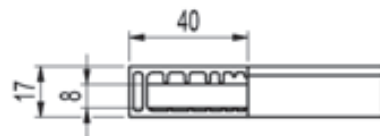
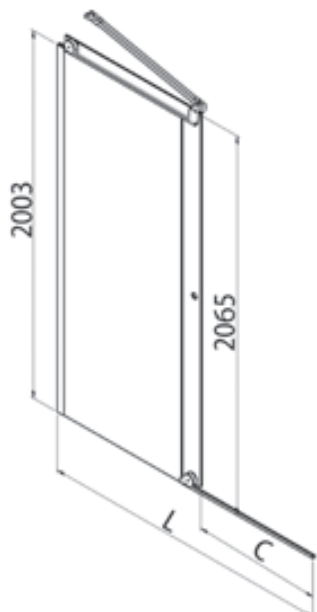



Le dimensioni sono espresse in mm.



SX

DX

L [cm]	Cod.	C [cm]	 [dm³]	 [kg]	 [n°]	Pannelli	ULU [€]	L91 [€]	L96 [€]	L73 - L86 [€]
100	B4600	42	144	50	1	TR	1071	1071	1071	1071
						TG	1232	1232	1232	1232
						RF	1232	1232	1232	1232
						GS	1393	1393	1393	1393
120	B4601	52	174	60	1	TR	1107	1107	1107	1107
						TG	1274	1274	1274	1274
						RF	1274	1274	1274	1274
						GS	1440	1440	1440	1440
140	B4602	62	244	67	1	TR	1157	1157	1157	1157
						TG	1331	1331	1331	1331
						RF	1331	1331	1331	1331
						GS	1505	1505	1505	1505
160	B4603	72	280	76	1	TR	1218	1218	1218	1218
						TG	1401	1401	1401	1401
						RF	1401	1401	1401	1401
						GS	1584	1584	1584	1584
180	B4604	82	314	84	1	TR	1353	1353	1353	1353
						TG	1556	1556	1556	1556
						RF	1556	1556	1556	1556
						GS	1759	1759	1759	1759

Tempi di consegna

1-2 settimane

2-3 settimane

3-4 settimane

Prodotti Speciali	Misure limite	I [€]	II [€]	III [€]
	H max 220 cm - min 150 cm / L max 220 cm - min 80 cm	240	240	240

Modulo di richiesta disponibile on-line sul sito: www.samo.it/it/prodotti-speciali - In caso di annullamento dopo l'accettazione, sarà addebitato il costo totale dell'ordine.

Trattamento anticalcare di serie compreso nel prezzo

Inquadrare il QR code per collegarsi alla pagina del sito www.samo.it per vedere altre combinazioni di pannelli e vetri

Kit Open

5

anni di
GARANZIA

206,5
cm

8
mm

GS-RF



Finitura pannelli

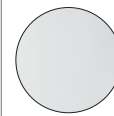

TR
Trasparente



TG
Trasparente grigio

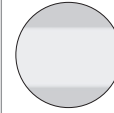

RF
Trasparente con fascia satinata
H 100 cm.

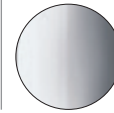

GS
Grigio satinato

Profili in alluminio



ULU
Brillantato cromo

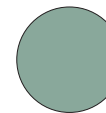

L73
Sage opaco

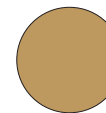

L86
Ambra opaco

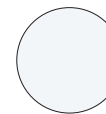



L91
Bianco opaco

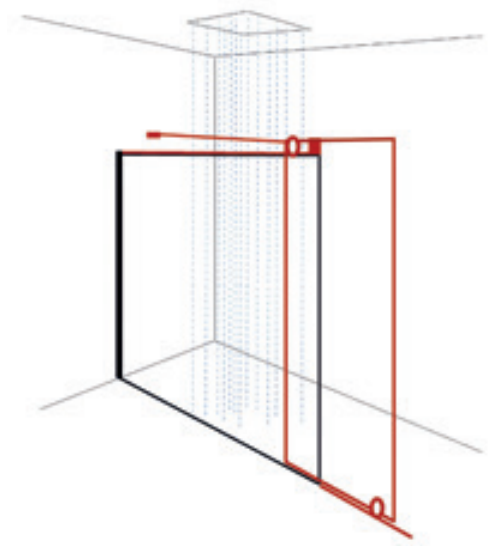

L96
Nero opaco



Condizione esistente

L [cm]	Cod.	C [cm]	 [dm³]	 [kg]	 [n°]	Pannelli	ULU [€]	L91 [€]	L96 [€]	L73 - L86 [€]
100	B461X	42	144	50	1	TR	677	677	677	//
						TG	779	779	779	//
						RF	779	779	779	//
						GS	881	881	881	//
Tempi di consegna				1-2 settimane		2-3 settimane		3-4 settimane		

Open

Kit optional

[cm]	Cod.	Descrizione	ULU [€]	L91 [€]	L96 [€]	L73 - L86 [€]
160	KT4650	Kit barra in linea per nicchia	167	167	167	167
	KT4600	Kit chiusura magnetica per porta scorrevole in nicchia	99	99	99	99
59,6	B01	Maniglia optional (indicare al momento dell'ordine)	108	//	//	//

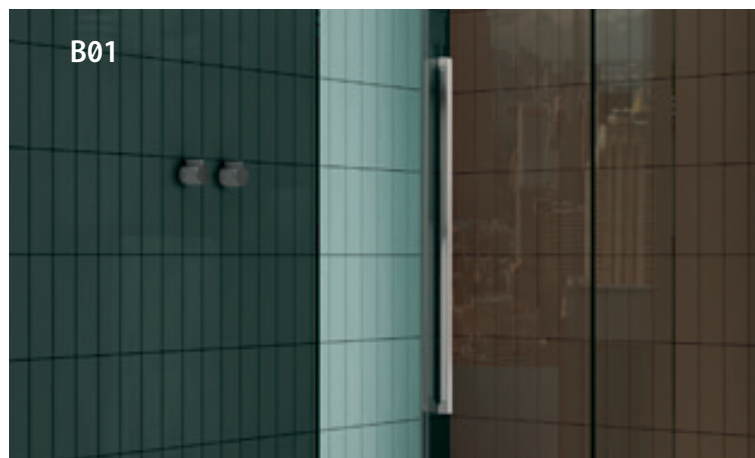
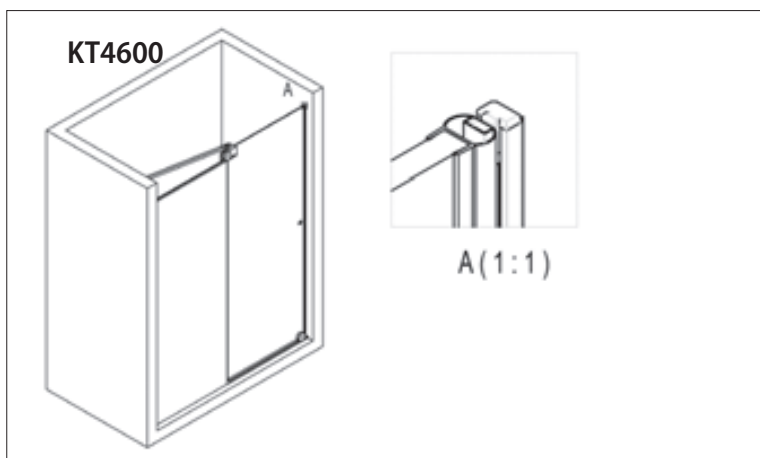
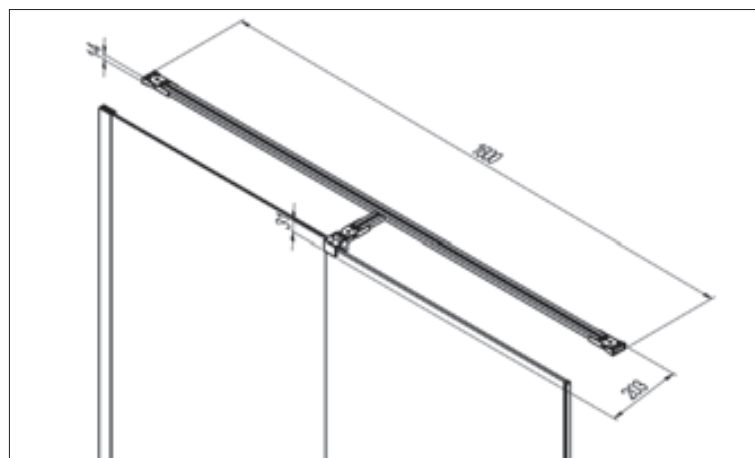

Open

5

anni di
GARANZIA

205,5
cm

8
mm



GS-RF



Finitura pannelli

-  TR
Trasparente
-  TG
Trasparente grigio
-  RF
Trasparente con fascia satinata
H 100 cm.
-  GS
Grigio satinato

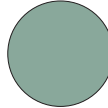
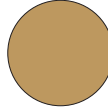
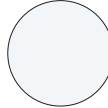

Profili in alluminio

-  ULU
Brillantato cromo
-  L73
Sage opaco
-  L86
Ambra opaco
-  L91
Bianco opaco
-  L96
Nero opaco

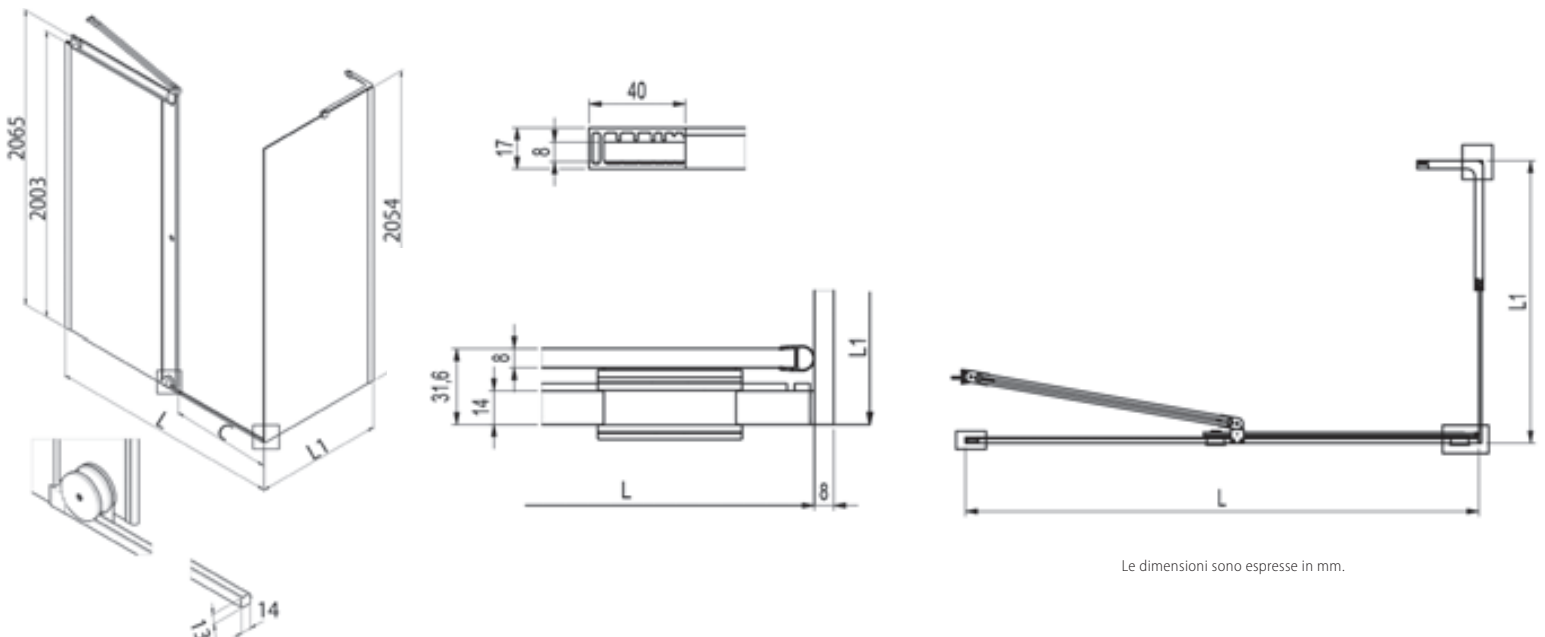
Parete fissa per abbinamenti, è possibile formare cabine doccia a due lati, anche per misure rettangolari. È possibile il montaggio anche senza piatto doccia.





Le dimensioni sono espresse in mm.

L1 [cm]	Cod.	C [cm]	 [dm³]	 [kg]	 [n°]	Pannelli	ULU [€]	L91 [€]	L96 [€]	L73 - L86 [€]
68-70	B4650	//	110	36	1	TR	560	560	560	560
						TG	644	644	644	644
						RF	644	644	644	644
						GS	728	728	728	728
78-80	B4651	//	120	42	1	TR	619	619	619	619
						TG	712	712	712	712
						RF	712	712	712	712
						GS	805	805	805	805
88-90	B4652	//	130	46	1	TR	699	699	699	699
						TG	804	804	804	804
						RF	804	804	804	804
						GS	909	909	909	909
98-100	B4653	//	145	50	1	TR	699	699	699	699
						TG	804	804	804	804
						RF	804	804	804	804
						GS	909	909	909	909

Open

Open scorrevole

H 206,5 cm. - V 8 mm.

L [cm]	Cod.	C [cm]	 [dm³]	 [kg]	 [n°]	Pannelli	ULU [€]	L91 [€]	L96 [€]	L73 - L86 [€]
100	B4600	42	144	50	1	TR	1071	1071	1071	1071
						TG	1232	1232	1232	1232
						RF	1232	1232	1232	1232
						GS	1393	1393	1393	1393
120	B4601	52	174	60	1	TR	1107	1107	1107	1107
						TG	1274	1274	1274	1274
						RF	1274	1274	1274	1274
						GS	1440	1440	1440	1440
140	B4602	62	244	67	1	TR	1157	1157	1157	1157
						TG	1331	1331	1331	1331
						RF	1331	1331	1331	1331
						GS	1505	1505	1505	1505
160	B4603	72	280	76	1	TR	1218	1218	1218	1218
						TG	1401	1401	1401	1401
						RF	1401	1401	1401	1401
						GS	1584	1584	1584	1584
180	B4604	82	314	84	1	TR	1353	1353	1353	1353
						TG	1556	1556	1556	1556
						RF	1556	1556	1556	1556
						GS	1759	1759	1759	1759

Tempi di consegna

1-2 settimane

2-3 settimane

3-4 settimane

Prodotti Speciali	Misure limite	I [€]	II [€]	III [€]
Parete fissa	H max 220 cm / L max 110 cm - min 30 cm	115	165	235
Open scorrevole	H max 220 cm - min 150 cm / L max 200 cm - min 80 cm	240	240	240

Modulo di richiesta disponibile on-line sul sito: www.samo.it/it/prodotti-speciali - In caso di annullamento dopo l'accettazione, sarà addebitato il costo totale dell'ordine.



Trattamento anticalcare di serie compreso nel prezzo



Inquadrare il QR code per collegarsi alla pagina del sito www.samo.it per vedere altre combinazioni di pannelli e vetri

Open Side

5

anni di
GARANZIA

200
cm

8
mm



Finitura pannelli

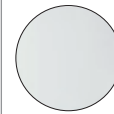

TR
Trasparente

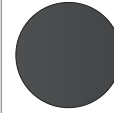

TG
Trasparente grigio

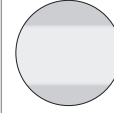

RF
Trasparente con fascia satinata
H 100 cm.

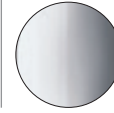

GS
Grigio satinato

Profili in alluminio



ULU
Brillantato cromo

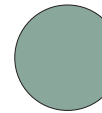

L73
Sage opaco

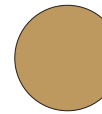

L86
Ambra opaco



L91
Bianco opaco



L96
Nero opaco

Cabina doccia spaziosa caratterizzata da area di accesso dedicata e anta fissa. Il vano di accesso alla doccia è totalmente libero. È possibile il montaggio anche senza piatto doccia: una guarnizione inferiore consente di isolare la parete in vetro dal piano di appoggio.



Le dimensioni sono espresse in mm.

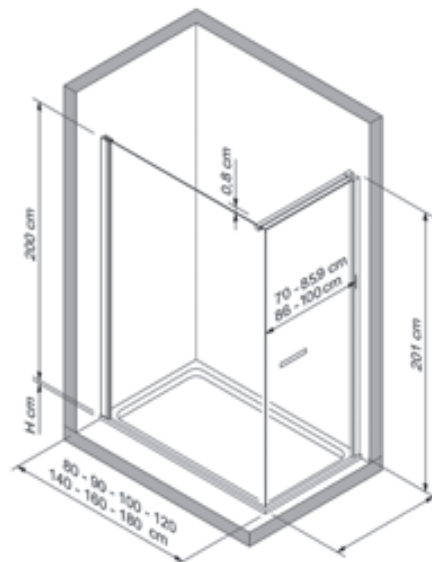
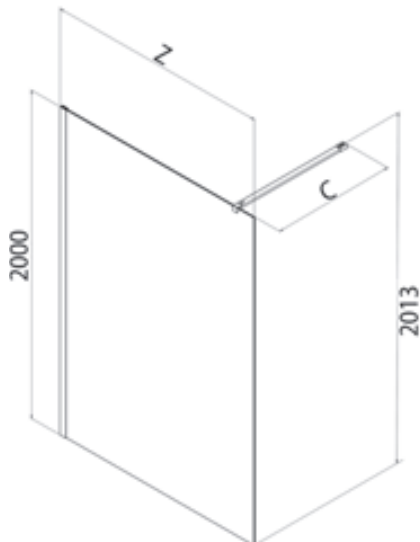



Porta non reversibile, indicare se DX o SX.
Apertura solo verso l'esterno.
Estensibilità = 2 cm.



SX



DX

Z [cm]	Cod.		C [cm]	 [dm ³]	 [kg]	 [n°]	Pannelli	ULU [€]	L91 [€]	L96 [€]	L73 - L86 [€]
76-78	B4081	//	120 max	120	34	1	TR	641	641	641	641
78-80	B4051	//					TG	738	738	738	738
86-88	B4082	//	120 max	135	39	1	RF	738	738	738	738
88-90	B4052	//					GS	834	834	834	834
96-98	B4083	//	120 max	150	44	1	TR	724	724	724	724
98-100	B4053	//					TG	833	833	833	833
116-118	B4084	//	120 max	181	54	1	RF	833	833	833	833
118-120	B4054	//					GS	942	942	942	942
136-138	B4085	//	120 max	244	64	1	TR	724	724	724	724
138-140	B4055	//					TG	833	833	833	833
156-158	B4086	//	120 max	270	75	1	RF	833	833	833	833
158-160	B4056	//					GS	942	942	942	942
176-178	B4087	//	120 max	300	83	1	TR	789	789	789	789
178-180	B4057	//					TG	908	908	908	908
							RF	908	908	908	908
							GS	1026	1026	1026	1026
							TR	855	855	855	855
							TG	984	984	984	984
							RF	984	984	984	984
							GS	1112	1112	1112	1112
							TR	921	921	921	921
							TG	1060	1060	1060	1060
							RF	1060	1060	1060	1060
							GS	1198	1198	1198	1198
							TR	987	987	987	987
							TG	1136	1136	1136	1136
							RF	1136	1136	1136	1136
							GS	1284	1284	1284	1284

N° 1 kit di sostegno vetro da 120 cm. compreso nel prezzo.

Open

Porta battente dedicata (6 mm.)



[cm]	Cod.		C [cm]	[dm ³]	[kg]	[n°]	Pannelli	ULU [€]	L91 [€]	L96 [€]	L73 - L86 [€]
70-85,9	B478X	//	62-78	107	25	1	TR	603	603	603	603
							TG	694	694	694	694
							RF	694	694	694	694
							GS	784	784	784	784
86-100	B478Y	//	78-92	120	32	1	TR	652	652	652	652
							TG	750	750	750	750
							RF	750	750	750	750
							GS	848	848	848	848

Abbinamento con parete fissa Open Side, porta NON reversibile indicare se DX o SX.
Estensibilità = 2 cm.

Tempi di consegna	1-2 settimane	2-3 settimane	3-4 settimane
-------------------	---------------	---------------	---------------

Prodotti Speciali	Misure limite	I [€]	II [€]	III [€]
Parete fissa	H max 220 cm - min 180 cm / L max 180 cm - min 50 cm	115	165	235
Porta	H max 220 cm / L max 100 cm - min 50 cm	115	165	235

Modulo di richiesta disponibile on-line sul sito: www.samo.it/it/prodotti-speciali - In caso di annullamento dopo l'accettazione, sarà addebitato il costo totale dell'ordine.

Supporto Optional	CRO [€]	L91 - L96 [€]	L73 - L86 [€]
RIC1809	Supporto vetro-muro 120 cm.	100	100



Trattamento anticalcare di serie compreso nel prezzo



Inquadrare il QR code per collegarsi alla pagina del sito www.samo.it per vedere altre combinazioni di pannelli e vetri

Open Shot

5

anni di
GARANZIA

200
cm

6
mm



Finitura pannelli

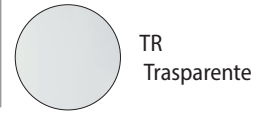

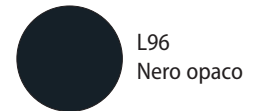

Profili in alluminio

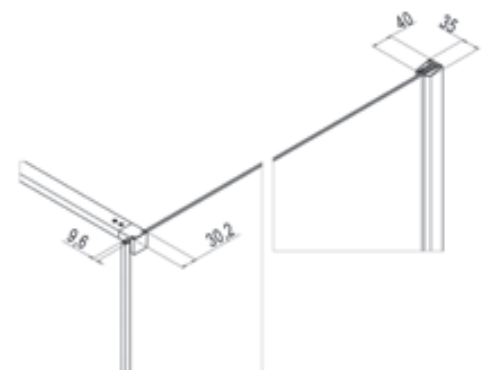
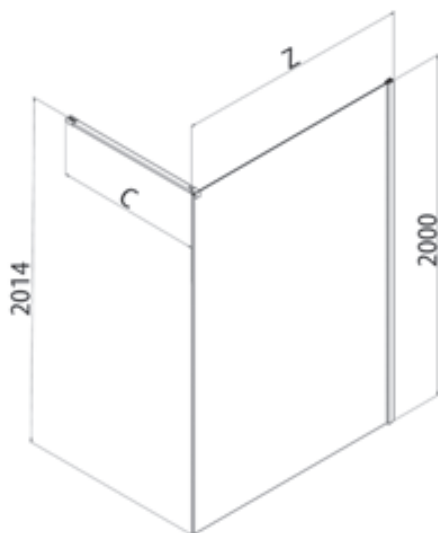

Cabina doccia spaziosa caratterizzata da area di accesso dedicata e anta fissa. Il vano di accesso alla doccia è totalmente libero. È possibile il montaggio anche senza piatto doccia: una guarnizione inferiore consente di isolare la parete in vetro dal piano di appoggio.



Z [cm]	Cod.	 [cm]	 [dm³]	 [kg]	[n°]	Pannelli	ULU [€]	L91 [€]	L96 [€]
76-78	B4091	120 max	120	34	1	TR	501	501	501
78-80	B4001						501	501	501
86-88	B4093	120 max	135	39	1	TR	529	529	529
88-90	B4003						529	529	529
96-98	B4095	120 max	150	44	1	TR	555	555	555
98-100	B4005						555	555	555
116-118	B4097	120 max	181	54	1	TR	612	612	612
118-120	B4007						612	612	612
136-138	B4099	120 max	244	64	1	TR	677	677	677
138-140	B4009						677	677	677

Tempi di consegna

1-2 settimane

2-3 settimane

3-4 settimane

Kit optional

[cm]	Cod.	Descrizione	ULU [€]	L91 [€]	L96 [€]
150	KT4091-1500	Kit di sostegno da 150 cm. (SENZA elementi di fissaggio muro / vetro)	68	68	68

Prodotti Speciali	Misure limite	I [€]	II [€]	III [€]
Parete fissa	H max 220 cm / L max 150 cm - min 50 cm	115	165	235

Modulo di richiesta disponibile on-line sul sito: www.samo.it/it/prodotti-speciali - In caso di annullamento dopo l'accettazione, sarà addebitato il costo totale dell'ordine.



Trattamento anticalcare di serie compreso nel prezzo



Inquadrare il QR code per collegarsi alla pagina del sito www.samo.it per vedere altre combinazioni di pannelli e vetri

Open Screen

5

anni di
GARANZIA

200
cm

8
mm



Finitura pannelli



TR
Trasparente



TG
Trasparente grigio



GS
Grigio satinato

Profili in alluminio



CRO
Cromato



L91
Bianco opaco

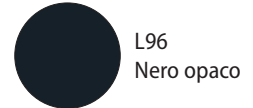

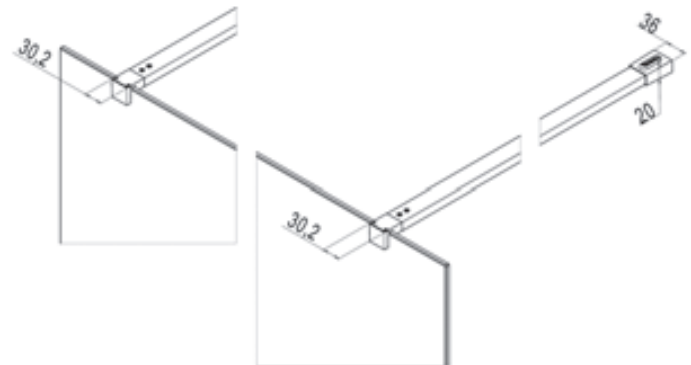
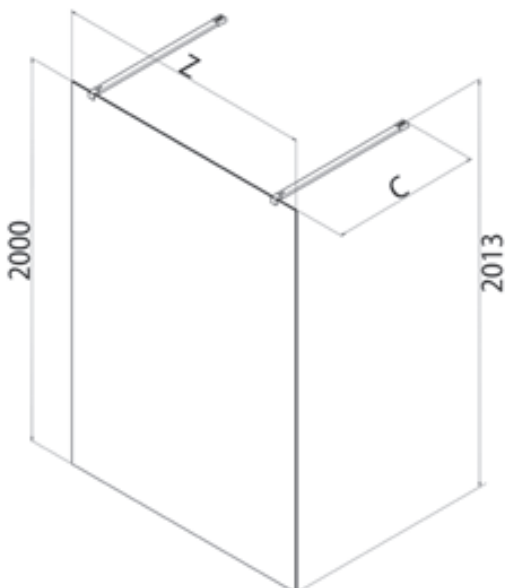

L96
Nero opaco

Cabina doccia spaziosa caratterizzata da area di accesso dedicata e anta fissa. Il vano di accesso alla doccia è totalmente libero. È possibile il montaggio anche senza piatto doccia: una guarnizione inferiore consente di isolare la parete in vetro dal piano di appoggio.



Le dimensioni sono espresse in mm.

Z [cm]	Cod.	C [cm]	 [dm³]	 [kg]	 [n°]	Pannelli	CRO [€]	L91 [€]	L96 [€]
96	B4073	120 max	133	42	1	TR	740	740	740
						TG	851	851	851
						GS	962	962	962
116	B4075	120 max	174	52	1	TR	793	793	793
						TG	912	912	912
						GS	1031	1031	1031
136	B4077	120 max	246	62	1	TR	848	848	848
						TG	976	976	976
						GS	1103	1103	1103

Kit optional					
	Cod.	Descrizione	ULU [€]	L91 - L96 [€]	L73 - L86 [€]
2670÷2720 mm.	KT4900	Profilo verticale pavimento-soffitto (vedi pag. 78)	288	288	288

Kit optional					
	Cod.	Descrizione	ULU [€]	L91 [€]	L96 [€]
1500 mm.	KT4091-1500	Kit di sostegno da 150 cm. (SENZA elementi di fissaggio muro/vetro)	68	68	68

Tempi di consegna	1-2 settimane	2-3 settimane	3-4 settimane
-------------------	---------------	---------------	---------------

Prodotti Speciali	Misure limite	I [€]	II [€]	III [€]
Parete fissa	H max 220 cm / L max 110 cm - min 30 cm	115	165	235

Modulo di richiesta disponibile on-line sul sito: www.samo.it/it/prodotti-speciali - In caso di annullamento dopo l'accettazione, sarà addebitato il costo totale dell'ordine.



Trattamento anticalcare di serie compreso nel prezzo



Inquadrare il QR code per collegarsi alla pagina del sito www.samo.it per vedere altre combinazioni di pannelli e vetri

5

anni di
GARANZIA



Profili in alluminio



ULU
Brillantato cromo

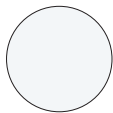

L91
Bianco opaco



L96
Nero opaco

Finitura pannelli

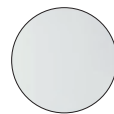

TR
Trasparente



TG
Trasparente grigio

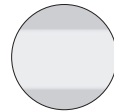

RF
Trasparente con fascia satinata
H 100 cm.



GS
Grigio satinato

B4045-49

KT4002 Speciale

B4040-41

B4081-87

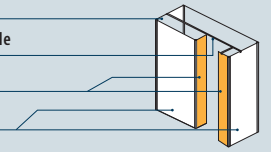

KT4001

B4081-87

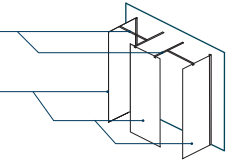

KT4002

B4040-41

B4081-87

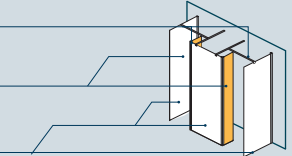

B4045-49

KT4002

B4040-41

B4081-87

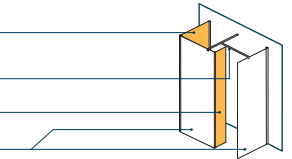

B4045-49

B4081-87

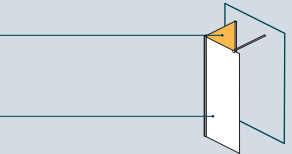

B4045-49

KT4000

B4081-87

B4040-41

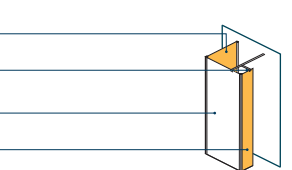

KT4000

B4081-87

B4040-41

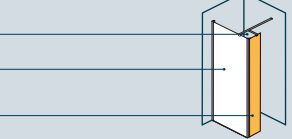

KT4001

B4081-87

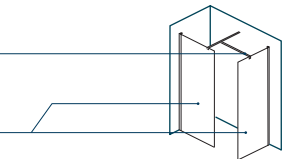

B4045-49

KT4001

B4081-87

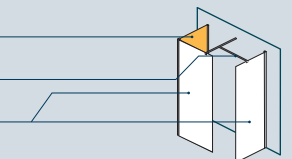

KT4002

B4040-41

B4081-87

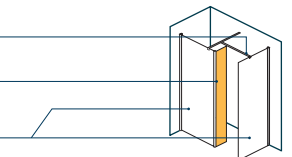

Z [cm]	Cod.	C [cm]	[dm³]	[kg]	[n°]	Pannelli	ULU [€]	L91 [€]	L96 [€]
20	B4040	120 max	133	42	1	TR	235	235	235
						TG	271	271	271
						RF	271	271	271
						GS	306	306	306
30	B4041	120 max	174	52	1	TR	261	261	261
						TG	301	301	301
						RF	301	301	301
						GS	340	340	340

Z [cm]	Cod.	C [cm]	[dm³]	[kg]	[n°]	Pannelli	ULU [€]	L91 [€]	L96 [€]
77-79	B4045	120 max	246	62	1	TR	564	564	564
						TG	649	649	649
						RF	649	649	649
						GS	734	734	734
87-89	B4047	120 max	246	62	1	TR	638	638	638
						TG	734	734	734
						RF	734	734	734
						GS	830	830	830
97-99	B4049	120 max	246	62	1	TR	638	638	638
						TG	734	734	734
						RF	734	734	734
						GS	830	830	830

Barra di sostegno obbligatoria per abbinamenti

mm.	Cod.	ULU [€]	L91 [€]	L96 [€]
150	KT4000	47	47	47
700	KT4001	80	80	80
700	KT4002	105	105	105

Tempi di consegna: 1-2 settimane (light blue), 2-3 settimane (pink), 3-4 settimane (grey)

Prodotti Speciali	Misure limite	I [€]	II [€]	III [€]
Parete fissa	H max 220 cm / L max 110 cm - min 30 cm	115	165	235

Modulo di richiesta disponibile on-line sul sito: www.samo.it/it/prodotti-speciali - In caso di annullamento dopo l'accettazione, sarà addebitato il costo totale dell'ordine.

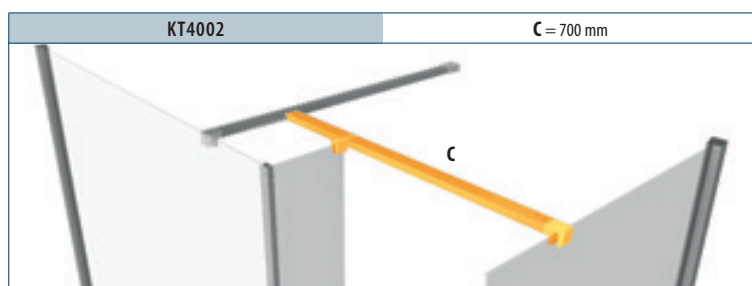
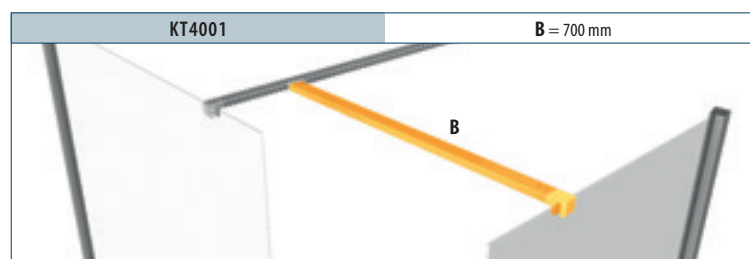
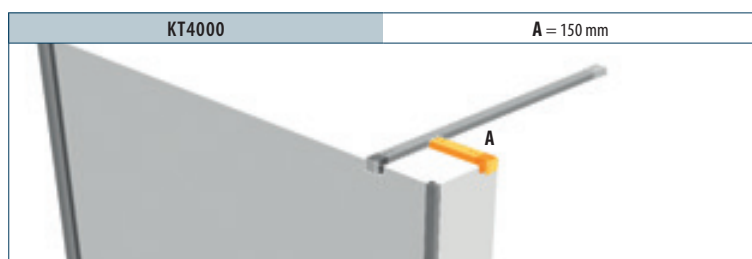

Kit Open

5



anni di
GARANZIA

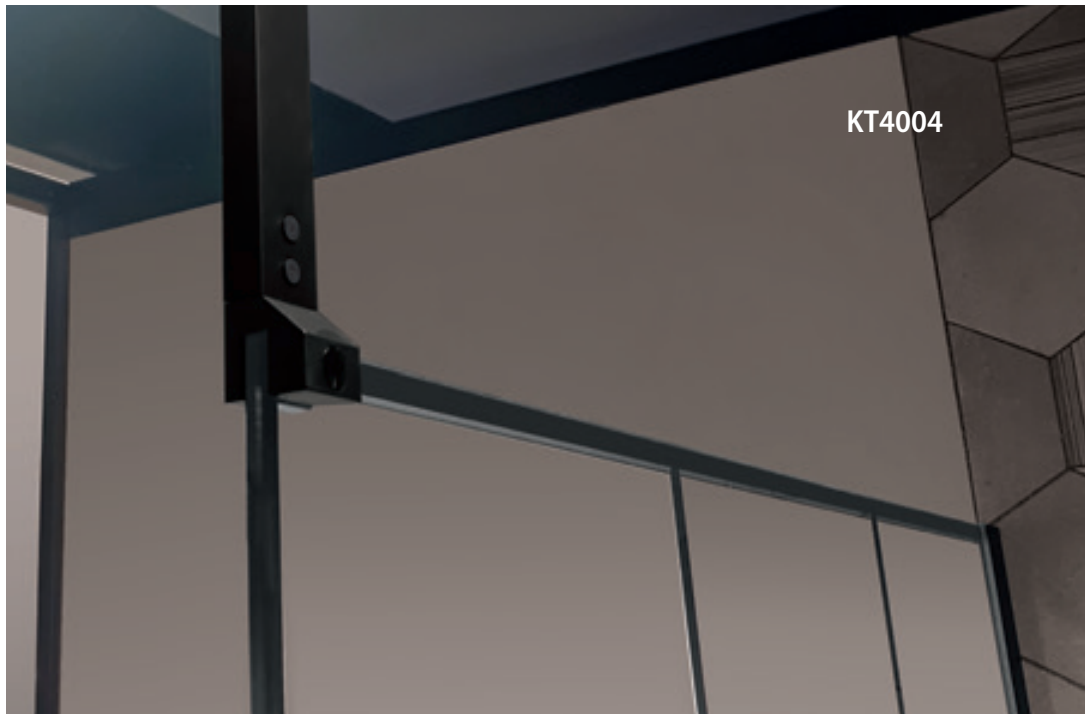
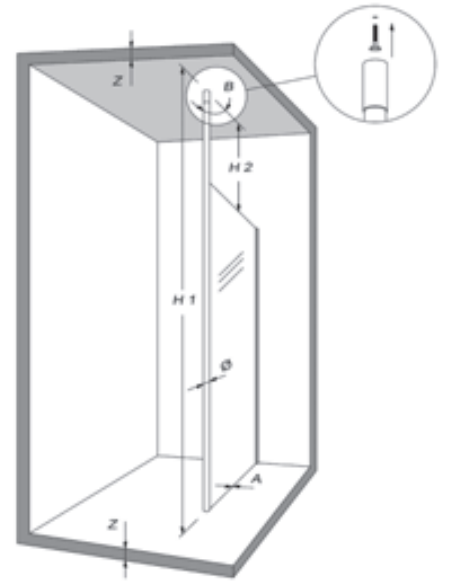

KT4900



KT4004

H1 [cm]	Cod.	H2 [cm]	A [mm]	B [mm]	∅ [mm]	 [dm ³]	 [kg]	 [n°]	Finiture	[€]
min 267 max 272	KT4900	min 25	144	50	4,5	28	6	1	L01	258
									ULU-L73-L86-L91-L96	288
									SAS-A06	375

È consigliato installare i prodotti su muri in calcestruzzo, mattoni pieni o forati, pietra e materiali compatti con uno spessore minimo di 50 mm.
 Profilo verticale in alluminio per il fissaggio della parete fissa con sistema pavimento-soffitto. Adatto a tutte le pareti fisse frameless con spessore vetro 6/8 mm.
 Brevetto per invenzione industriale. L'utilizzo del sistema aumenta la misura dell'estensibilità della parete fissa di 3 cm.

mm.	Cod.	Descrizione		[€]
30x30x30	KT4004	Sistema di ancoraggio a soffitto	CRO	47
			L91	47
			L96	47

È consigliato installare i prodotti su muri in calcestruzzo, mattoni pieni o forati, pietra e materiali compatti con uno spessore minimo di 50 mm.

185x155	KT4710	Zanca piccola optional	CRO	185
			L91 - L96	185
405x205	KT4720	Zanca grande optional	CRO	210
			L73 - L86	210
			L91 - L96	210
750-850	KT0	Kit Exclusive, paletto di sostegno ancorato al vetro (NON ordinabile singolarmente), solo per vetro 8 mm.	CRO	130
			L91 - L96	130
1120	KT1400	Kit zanca lunga snodata	ULU	99
			L91 - L96	99

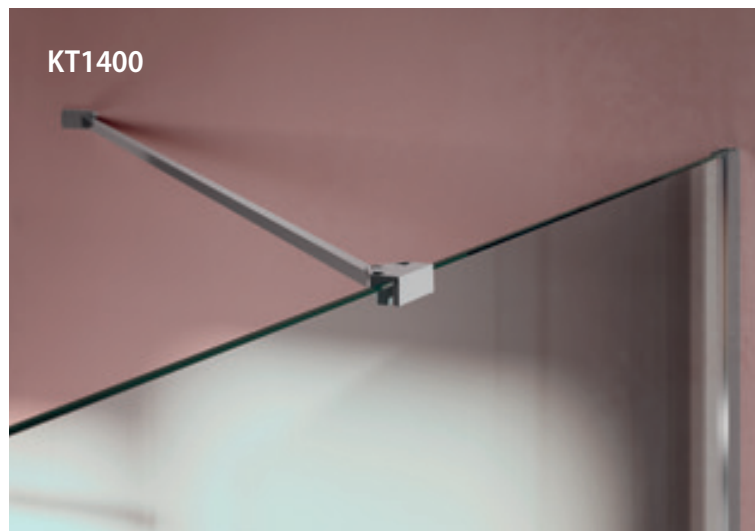





Zenith

Eleganza su misura





B9187ULUTG

Zenith



B9173ULUTG

PLUS DI PRODOTTO



- H 200 cm – V 8 mm
- 2 cm di regolazione del fuorisquadra
- Profili verticali con fissaggio a pinza (gestione dell'estensibilità nascosta)
- Cerniere incollate con tecnologia UV (facilità di pulizia e impatto estetico)
- Apertura interno-esterno con sollevamento
- Barra stabilizzatrice con fissaggi nascosti
- Filo interno vetro su cerniere e guarnizioni
- Viti non in vista
- Possibilità di installare il prodotto con o senza frangiflutto
- Interasse maniglia 580 mm
- Anticalcare compreso nel prezzo
- Stampa digitale disponibile su tutti i vetri piani TR e TG







DD
Brezza

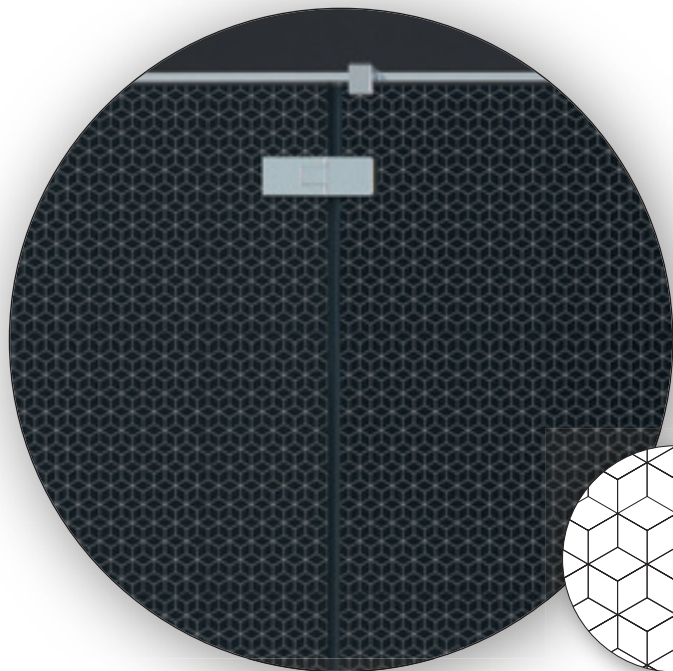
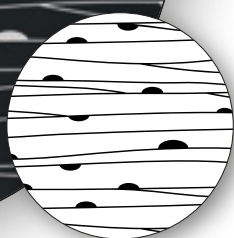

DH
Cubix

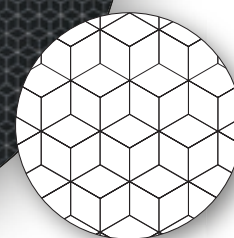

DI
Fronda

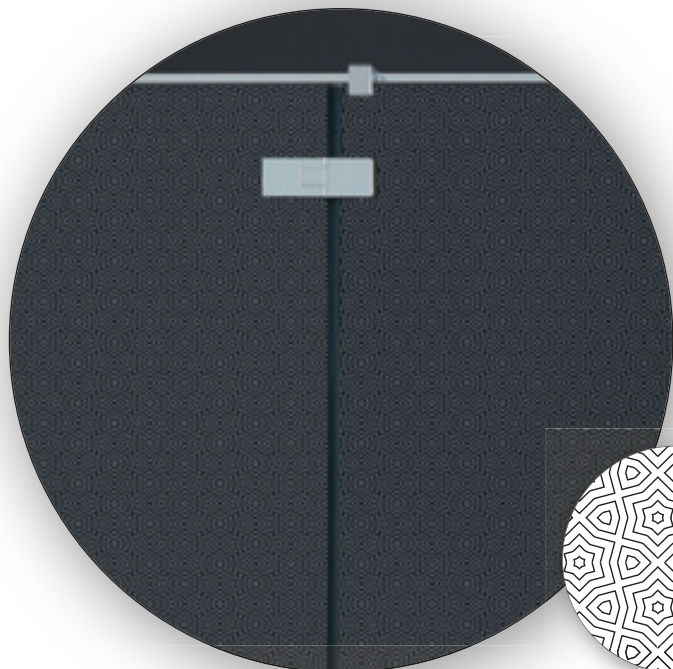

DK
Exagon

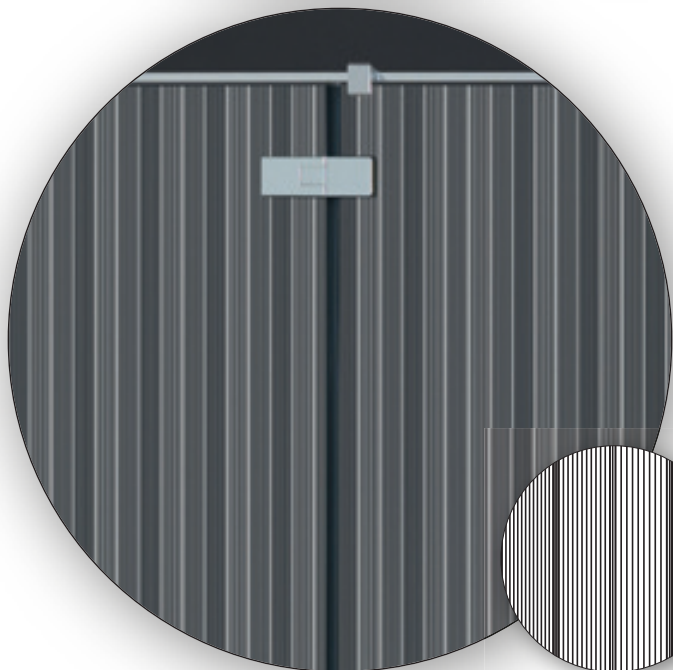

DM
Wave

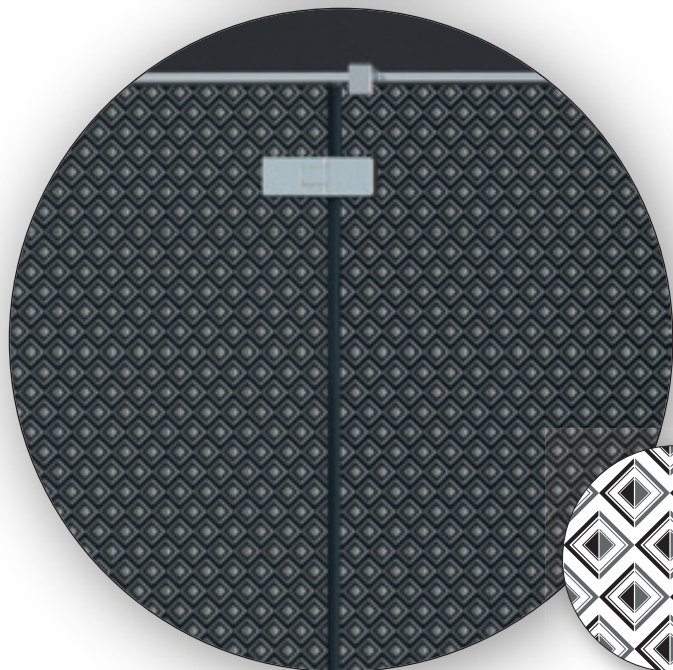
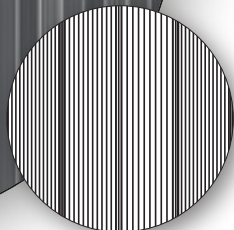

DN
Rombi



Zenith

Stampa digitale
su vetro piano



DK
Exagon

Zenith

Zenith



Finitura pannelli

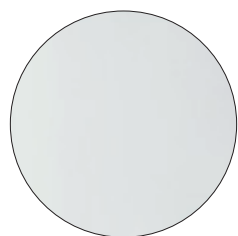

TR
Trasparente

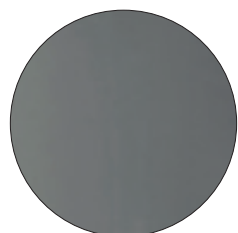

TG
Trasparente Grigio



Trattamento anticalcare di serie compreso nel prezzo

Profili in alluminio



ULU
Brillantato cromo

Angoli

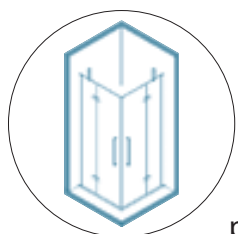

p. 90

Porte

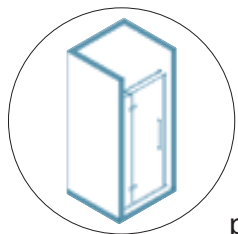

p. 92

Pareti fisse

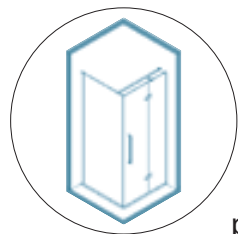

p. 94

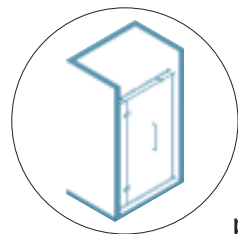

p. 96

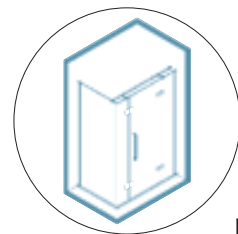

p. 98

5

anni di
GARANZIA

200
cm

8
mm



Finitura pannelli

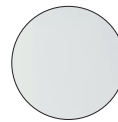

TR Trasparente

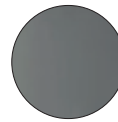

TG Trasparente Grigio

Profili in alluminio



ULU Brillantato cromo



Trattamento anticalcare di serie
compreso nel prezzo

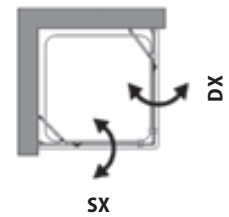

Angolo a quattro ante, due pareti fisse e due battenti apribili verso l'interno e verso l'esterno.
Apertura ad anta ripiegabile grazie a cerniere snodate a 90° verso l'interno e l'esterno.

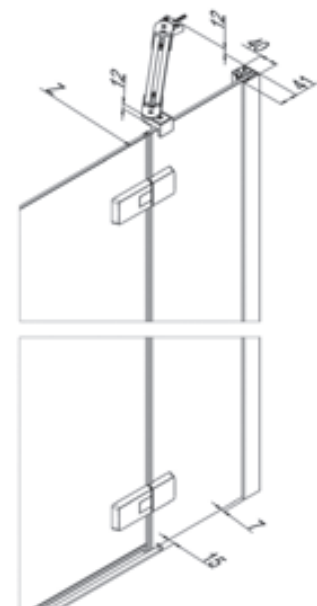
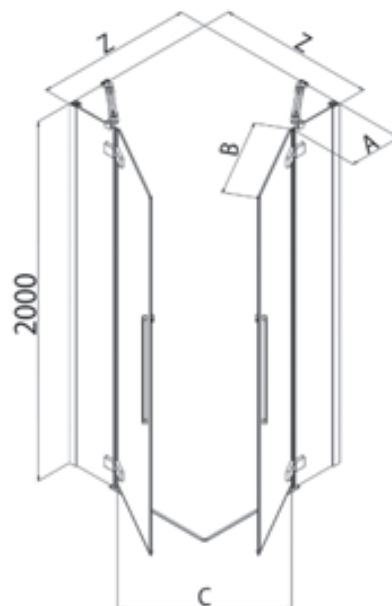
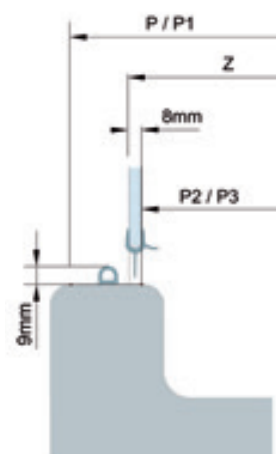

Le dimensioni sono espresse in mm.

Estensibilità Z [cm]	Cod.	ingombro max Z + 1,5 [cm]	A [cm]	B [cm]	C [cm]	[dm³]	[kg]	[n°]	Pannelli	ULU [€]
76-78	B9111 [1 Lato]	77,5-79,5	26,1-28,1	49	65	140	41	1	TR	1294
									TG	1489
86-88	B9112 [1 Lato]	87,5-89,5	29,3-31,3	56	74	158	45	1	TR	1322
									TG	1521
96-98	B9113 [1 Lato]	97,5-99,5	35,5-37,5	60	80	180	49	1	TR	1379
									TG	1586
116-118	B9115 [1 Lato]	117,5-119,5	44,3-46,3	71	96	207	68	2	TR	1463
									TG	1683
Tempi di consegna				1-2 settimane		2-3 settimane		3-4 settimane		

N.B. I valori della tabella prezzi si riferiscono ad un singolo lato: sommare l'importo dei due codici della misura desiderata per ottenere il prezzo totale di una doccia ad angolo quadrata o rettangolare. Apertura determinata con due lati della stessa misura. La misura dell'estensibilità "Z" è intesa dal muro al filo lastra esterno. Sommare l'ingombro del profilo del frangiflutto (15 mm.), per determinare l'ingombro massimo.

Maniglia in vetro temperato	Optional	1pz [€]
B00	da richiedere al momento dell'ordine	105

Prodotti Speciali	Misure limite	I [€]	II [€]	III [€]
		H: max 217 cm - min 150 cm L: max 160 cm - min 66 cm	170	185

Modulo di richiesta disponibile on-line sul sito: www.samo.it/it/prodotti-speciali - In caso di annullamento dopo l'accettazione, sarà addebitato il costo totale dell'ordine.

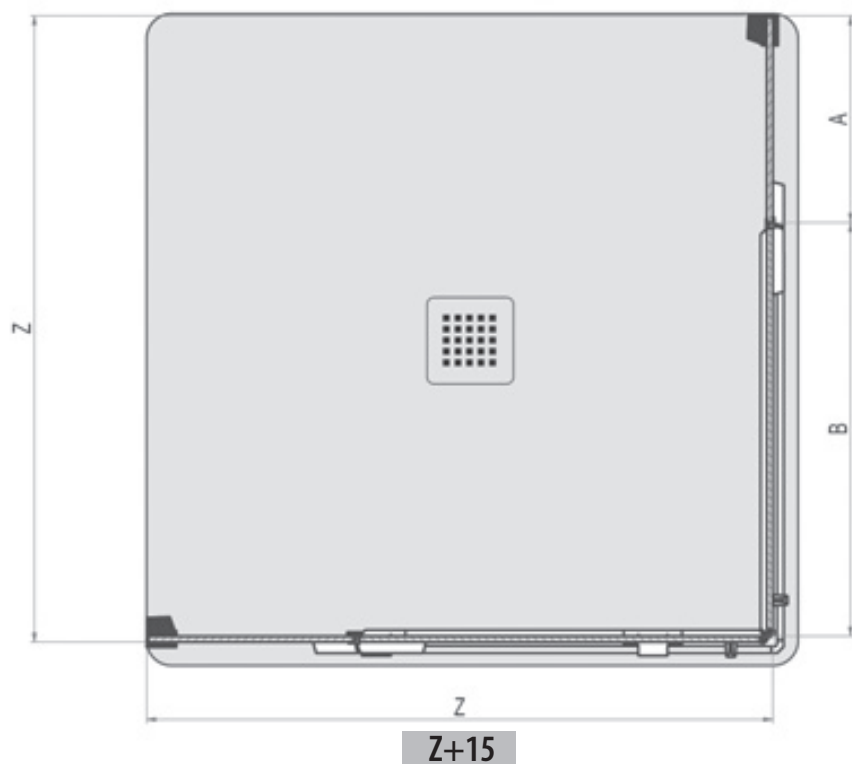

Inquadrare il QR code per collegarsi alla pagina del sito www.samo.it per vedere altre combinazioni di pannelli e vetri

Le dimensioni sono espresse in mm.

5

anni di
GARANZIA

200
cm

8
mm



Finitura pannelli

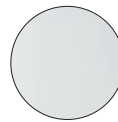

TR Trasparente

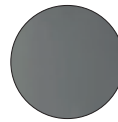

TG Trasparente Grigio

Profili in alluminio



ULU Brillantato cromo



Trattamento anticalcare di serie
compreso nel prezzo

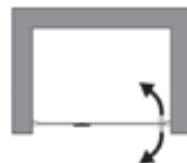

SX



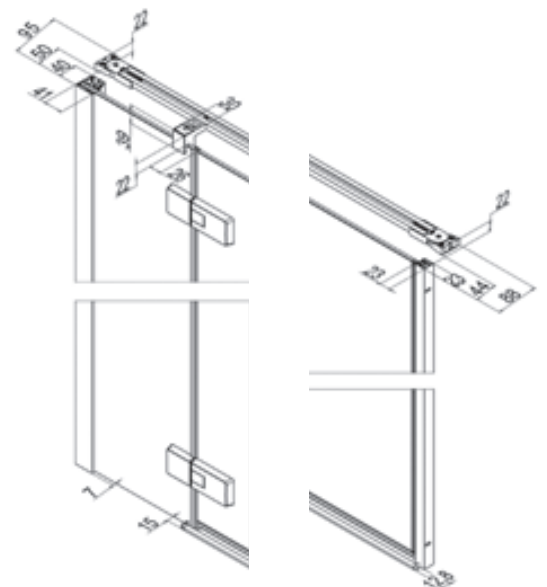
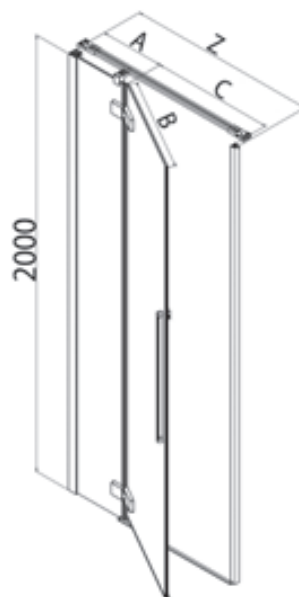
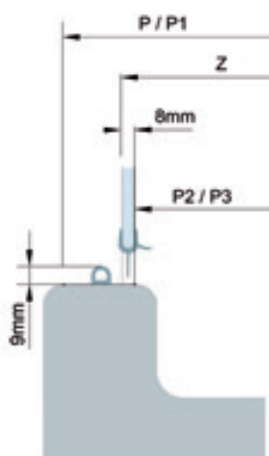

DX

Porta ad un'anta a battente, una parete fissa e una battente apribile verso l'interno e l'esterno.
Apertura ad anta ripiegabile grazie a cerniere snodate a 90° verso l'interno e l'esterno.



Le dimensioni sono espresse in mm.

Estensibilità Z [cm]	Cod.	A [cm]	B [cm]	C [cm]	D [cm]	 [dm³]	 [kg]	 [n°]	Pannelli	ULU [€]
77,5-80,5	B9101	26,1-28,1	49	46	2,3-3,3	140	41	1	TR	1336
									TG	1537
87,5-90,5	B9102	29,3-31,3	56	53	2,3-3,3	158	45	1	TR	1365
									TG	1570
97,5-100,5	B9103	35,5-37,5	60	57	2,3-3,3	180	49	1	TR	1393
									TG	1602
117,5-120,5	B9105	44,3-46,3	71	68	2,3-3,3	207	68	2	TR	1479
									TG	1701
137,5-140,5	B9107	64,2-66,2	71	68	2,3-3,3	218	78	2	TR	1574
									TG	1811

Tempi di consegna	1-2 settimane	2-3 settimane	3-4 settimane
-------------------	---------------	---------------	---------------

Maniglia in vetro temperato	Optional	1pz [€]
B00	da richiedere al momento dell'ordine	105

Prodotti Speciali	Misure limite	I [€]	II [€]	III [€]
	H: max 217 cm - min 150 cm L: max 160 cm - min 67,5 cm	185	200	235

Modulo di richiesta disponibile on-line sul sito: www.samo.it/it/prodotti-speciali - In caso di annullamento dopo l'accettazione, sarà addebitato il costo totale dell'ordine.

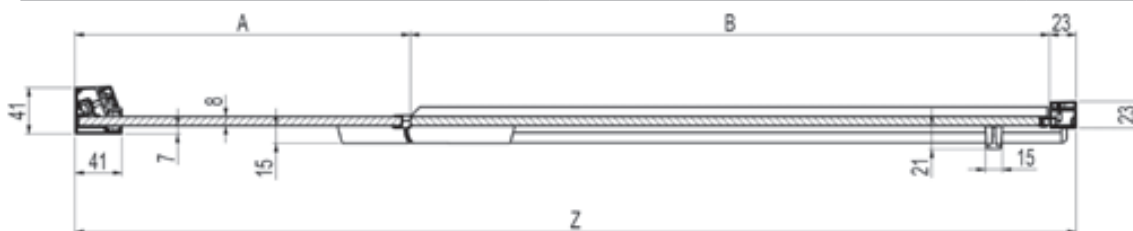

Le dimensioni sono espresse in mm.



Inquadrare il QR code per collegarsi alla pagina del sito www.samo.it per vedere altre combinazioni di pannelli e vetri



5
anni di
GARANZIA

200
cm

8
mm



Finitura pannelli

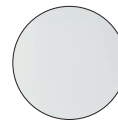

TR Trasparente

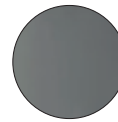

TG Trasparente Grigio

Profili in alluminio



ULU Brillantato cromo



Trattamento anticalcare di serie
compreso nel prezzo



SX

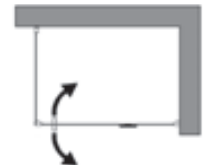

DX

Parete fissa per abbinamenti, è possibile formare box a 2 lati con porta battente a due ante, anche misure rettangolari.

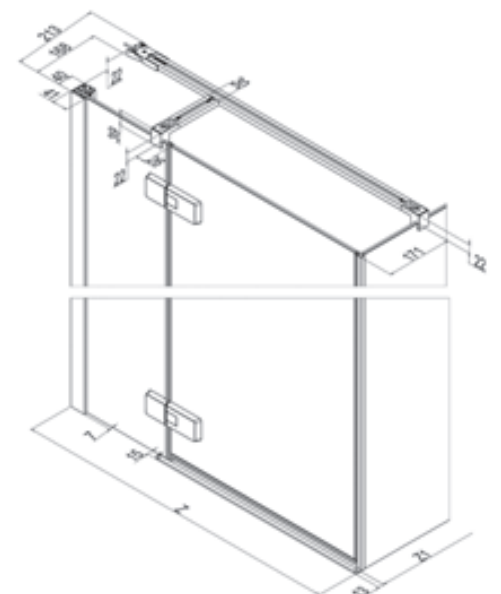
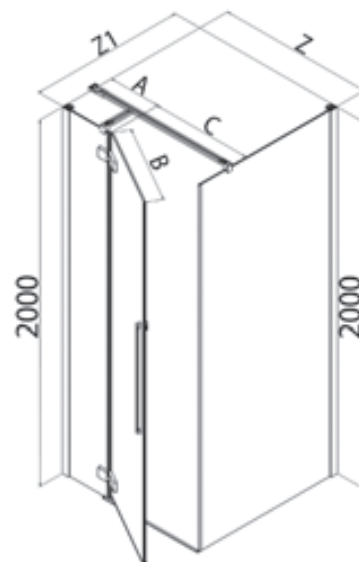
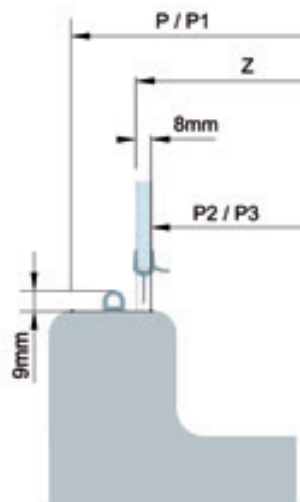



Estensibilità Z1 [cm]	Cod.	ingombro max Z1 + 1,5 [cm]	A [cm]	B [cm]	C [cm]	[dm³]	[kg]	[n°]	Pannelli	ULU [€]
76-78	B9121	76,7-78,7	26,1-28,1	49	46	140	41	1	TR	1336
									TG	1537
86-88	B9122	86,7-88,7	29,3-31,3	56	53	158	45	1	TR	1365
									TG	1570
96-98	B9123	96,7-98,7	35,5-36,5	60	57	180	49	1	TR	1393
									TG	1602
116-118	B9125	116,7-118,7	44,3-46,3	71	68	207	68	2	TR	1479
									TG	1701
136-138	B9127	136,7-138,7	64,2-66,2	71	68	218	76	2	TR	1574
									TG	1811

Zenith

Parete fissa per abbinamenti con porta a due ante



Estensibilità Z [cm]	Cod.	ingombro max Z + 0,7 [cm]	A	B	C	[dm³]	[kg]	[n°]	Pannelli	ULU [€]
66-68	B9150	67,5-69,5	//	//	//	128	37	1	TR	851
									TG	936
76-78	B9151	77,5-79,5	//	//	//	146	41	1	TR	851
									TG	936
86-88	B9152	87,5-89,5	//	//	//	166	45	1	TR	878
									TG	966
96-98	B9153	97,5-99,5	//	//	//	182	49	1	TR	904
									TG	995

La parete fissa è reversibile

Tempi di consegna	1-2 settimane	2-3 settimane	3-4 settimane
-------------------	---------------	---------------	---------------

Prodotti Speciali	Misure limite	I [€]	II [€]	III [€]
Parete fissa	H: max 217 cm - min 50 cm / L: max 140 cm - min 29 cm	115	140	180
Porta a due ante con battente	H: max 217 cm - min 150 cm / L: max 160 cm - min 67,5 cm	185	200	235

Modulo di richiesta disponibile on-line sul sito: www.samo.it/it/prodotti-speciali - In caso di annullamento dopo l'accettazione, sarà addebitato il costo totale dell'ordine.

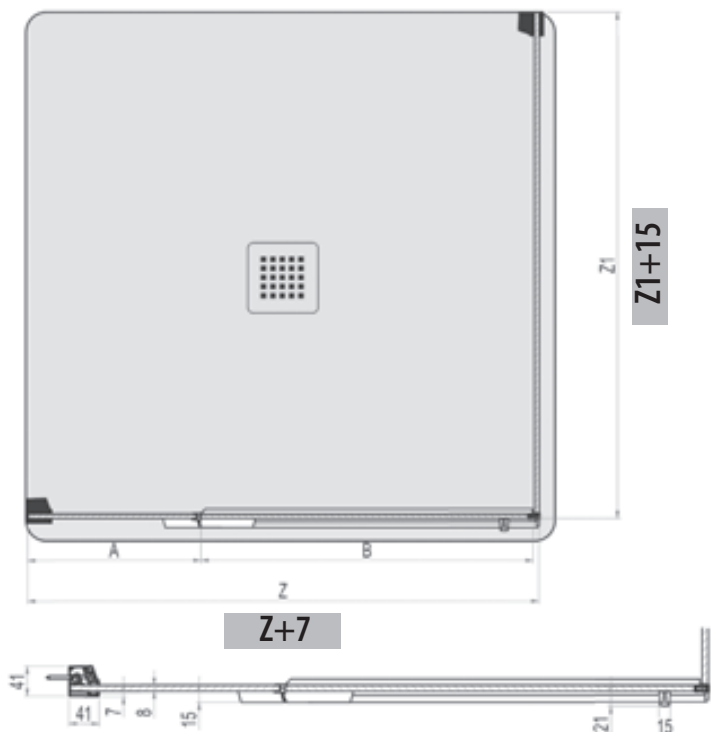

Inquadrare il QR code per collegarsi alla pagina del sito www.samo.it per vedere altre combinazioni di pannelli e vetri

5

anni di
GARANZIA

200
cm

8
mm



Finitura pannelli

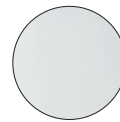

TR Trasparente

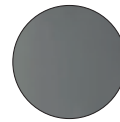

TG Trasparente Grigio

Profili in alluminio



ULU Brillantato cromo



Trattamento anticalcare di serie
compreso nel prezzo



SX

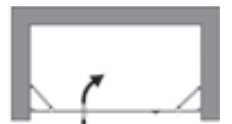

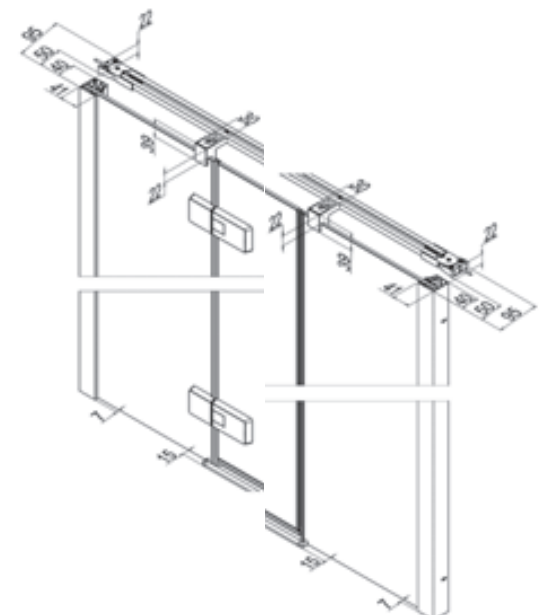
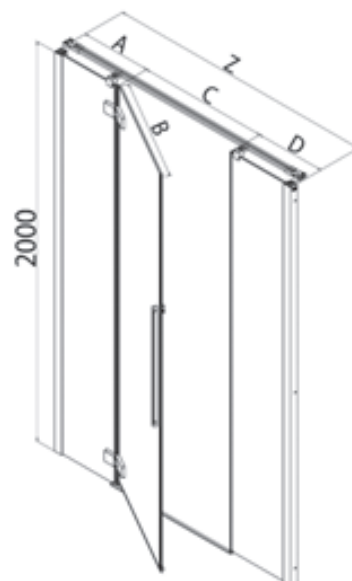
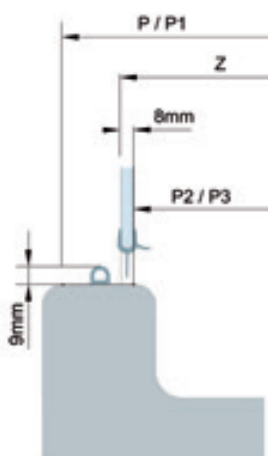

DX

Porta a tre ante, due fisse laterali e una apribile frontale verso l'interno e l'esterno.
Apertura ad anta ripiegabile grazie a cerniere snodate a 90° verso l'interno e l'esterno



Le dimensioni sono espresse in mm.

Estensibilità Z [cm]	Cod.	A [cm]	B [cm]	C [cm]	D [cm]	 [dm ³]	 [kg]	 [n°]	Pannelli	ULU [€]
116-120	B9182	30,1-32,1	56	53	30,1-32,1	207	68	2	TR	1899
									TG	2184
136-140	B9184	35,5-37,5	65	62	35,5-37,5	218	76	2	TR	1970
									TG	2266
146-150	B9185	40,5-42,5	65	62	40,5-42,5	223	80	2	TR	2066
									TG	2376
166-170	B9187	47,6-49,6	71	68	47,6-49,6	242	88	2	TR	2180
									TG	2507

Tempi di consegna	1-2 settimane	2-3 settimane	3-4 settimane
-------------------	---------------	---------------	---------------

Maniglia in vetro temperato	Optional	1pz [€]
B00	da richiedere al momento dell'ordine	105

Prodotti Speciali	Misure limite	I [€]	II [€]	III [€]
	H: max 217 cm - min 150 cm L: max 210 cm - min 100 cm	200	215	250

Modulo di richiesta disponibile on-line sul sito: www.samo.it/it/prodotti-speciali - In caso di annullamento dopo l'accettazione, sarà addebitato il costo totale dell'ordine.

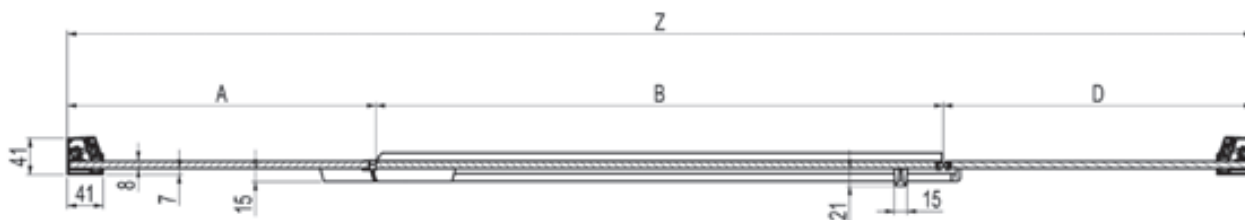

Le dimensioni sono espresse in mm.



Inquadrare il QR code per collegarsi alla pagina del sito www.samo.it per vedere altre combinazioni di pannelli e vetri



5

anni di
GARANZIA

200
cm

8
mm



Finitura pannelli

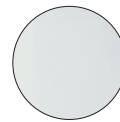

TR Trasparente

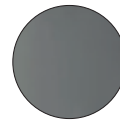

TG Trasparente Grigio

Profili in alluminio



ULU Brillantato cromo



Trattamento anticalcare di serie
compreso nel prezzo

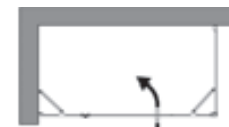

SX



DX

Parete fissa per abbinamenti, è possibile formare box a 2 lati con porte battenti a tre ante, anche misure rettangolari.
Il Kit di sostegno obbligatorio è compreso nell'imballo.

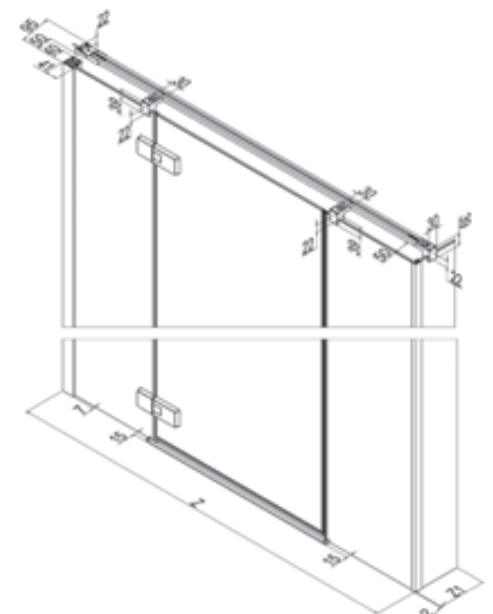
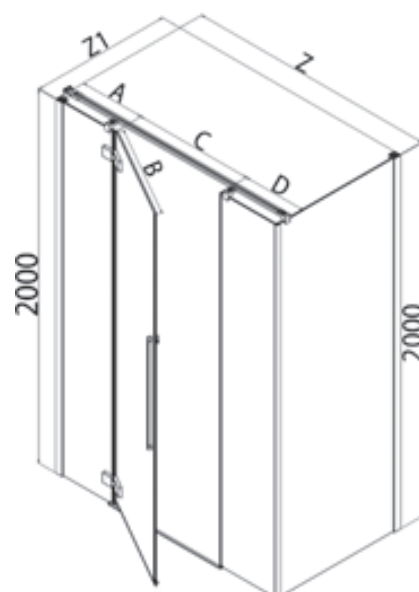
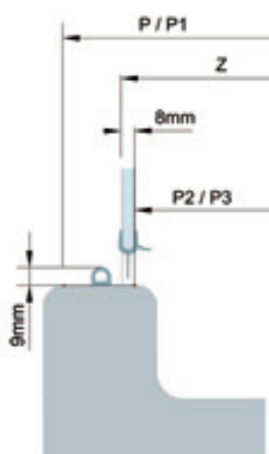

Le dimensioni sono espresse in mm.



Estensibilità Z1 [cm]	Cod.	ingombro max Z1 + 1,5 [cm]	A [cm]	B [cm]	C [cm]	[dm ³]	[kg]	[n°]	Pannelli	ULU [€]
116-120	B9182	116,7-118,7	30,1-32,1	56	53	207	68	2	TR	1899
									TG	2184
136-140	B9184	136,7-138,7	35,5-37,5	65	62	218	76	2	TR	1970
									TG	2266
146-150	B9185	146,7-148,7	40,5-42,5	65	62	223	80	2	TR	2066
									TG	2376
166-170	B9187	166,7-168,7	47,6-49,6	71	68	242	88	2	TR	2180
									TG	2507

Parete fissa per abbinamenti con porta battente a tre ante



Estensibilità Z	Cod.	ingombro max Z + 0,7 [cm]	A	B	C	[dm ³]	[kg]	[n°]	Pannelli	ULU [€]
66-68	B9170	67,5-69,5	//	//	//	128	37	1	TR	851
									TG	936
76-78	B9171	77,5-79,5	//	//	//	146	41	1	TR	851
									TG	936
86-88	B9172	87,5-89,5	//	//	//	166	45	1	TR	878
									TG	966
96-98	B9173	97,5-99,5	//	//	//	182	49	1	TR	904
									TG	995

La parete fissa è reversibile

Tempi di consegna	1-2 settimane	2-3 settimane	3-4 settimane
-------------------	---------------	---------------	---------------

Prodotti Speciali	Misure limite	I [€]	II [€]	III [€]
Parete fissa	H: max 217 cm - min 50 cm / L: max 140 cm - min 19 cm	115	140	180
Porta a due ante con battente	H: max 217 cm - min 150 cm / L: max 210 cm - min 100 cm	200	215	250

Modulo di richiesta disponibile on-line sul sito: www.samo.it/it/prodotti-speciali - In caso di annullamento dopo l'accettazione, sarà addebitato il costo totale dell'ordine.

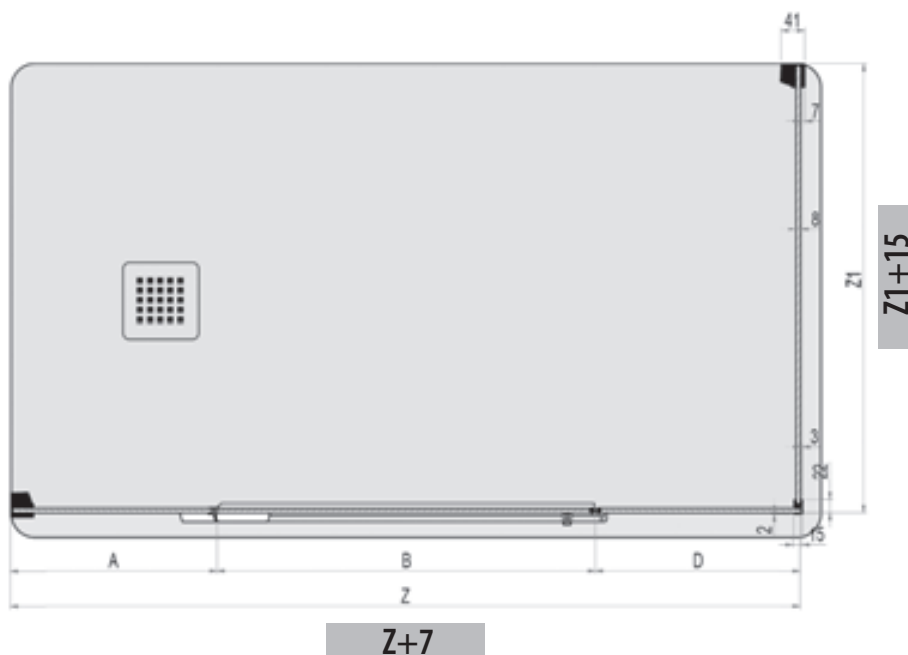

Inquadrare il QR code per collegarsi alla pagina del sito www.samo.it per vedere altre combinazioni di pannelli e vetri

Le dimensioni sono espresse in mm.

Grand Polaris

Delicata bellezza





Grand Polaris





B3735ULUAS



B3735ULUASDN

PLUS DI PRODOTTO



- H 195 cm – V 6 mm
- 2,5 cm di regolazione del fuorisquadra
- Profili verticali con fissaggio a pinza (gestione dell'estensibilità nascosta)
- Cerniere filo interno vetro apribili a 180° verso l'esterno con sollevamento anta
- Profili porta magnete in alluminio
- Barra stabilizzatrice optional
- Profilo di compensazione dedicato
- Copertura completa delle misure
- Carter copertura viti a muro
- Interasse maniglia 160 mm
- Anticalcare compreso nel prezzo
- Stampa digitale disponibile su tutti i vetri piani TR

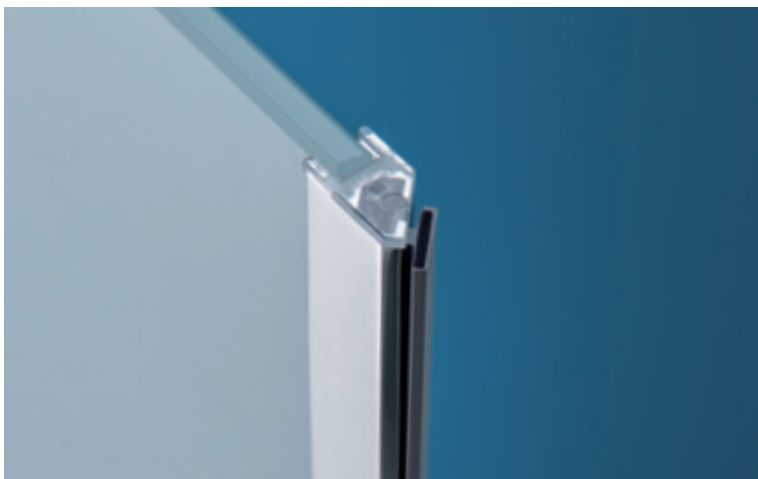

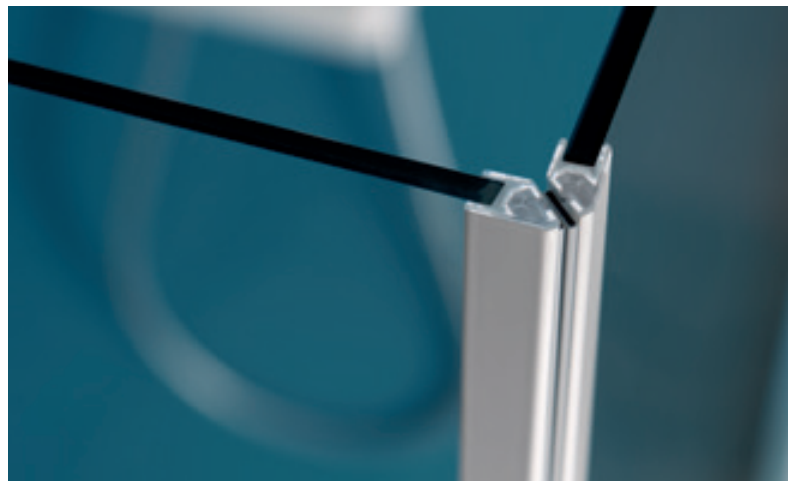

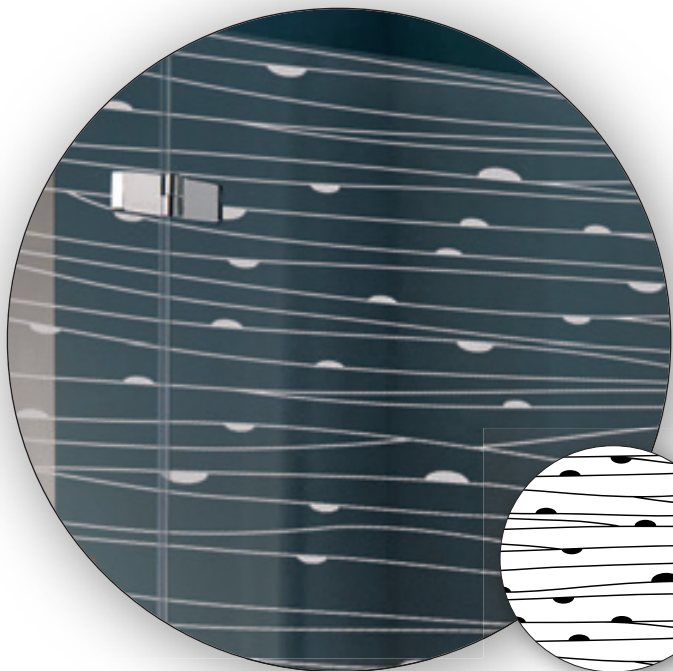

DD
Brezza

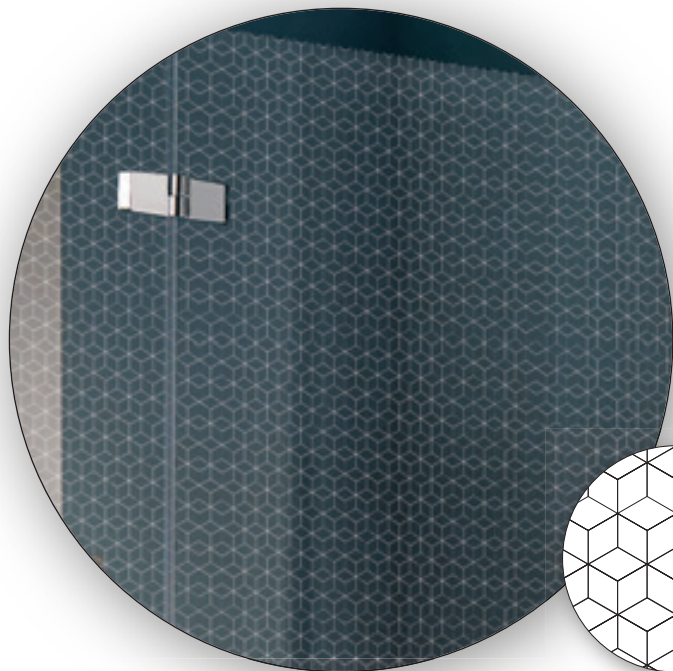
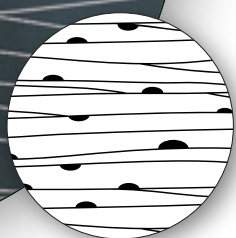

DH
Cubix

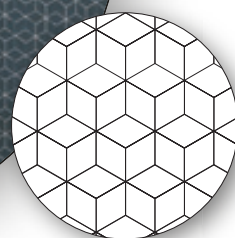

DI
Fronda



DK
Exagon

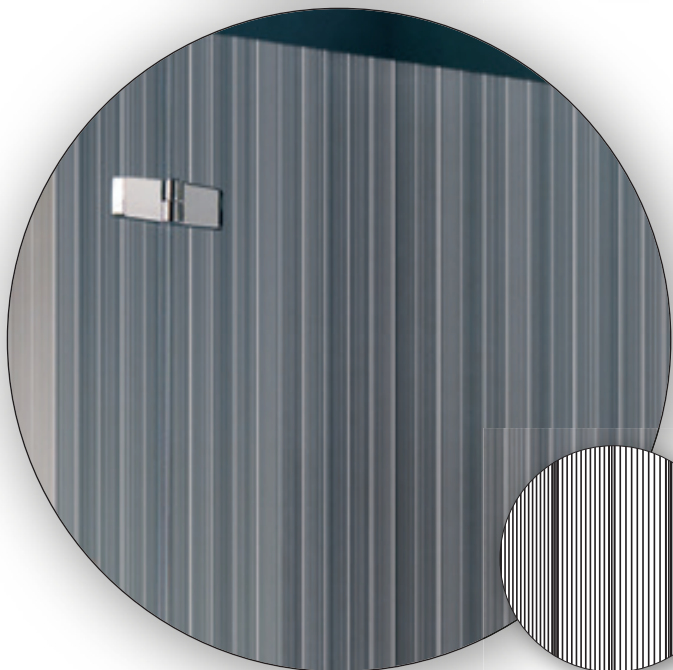
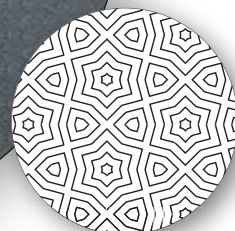

DM
Wave

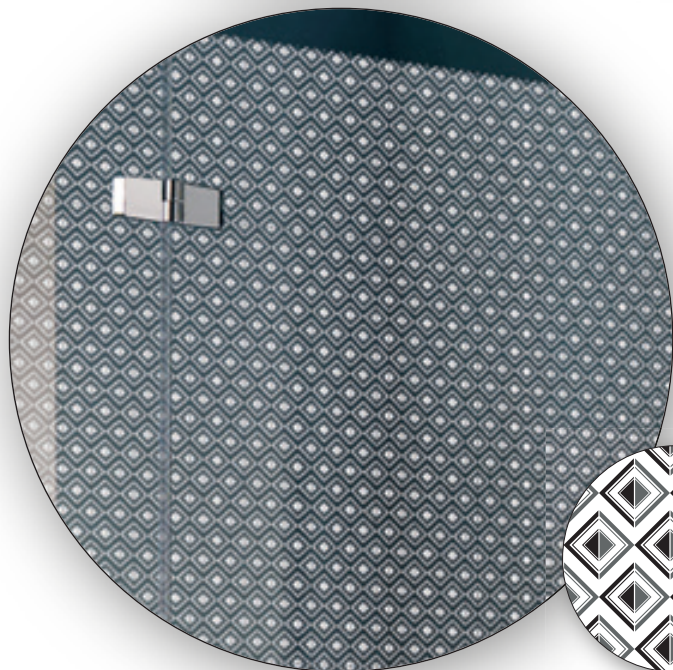
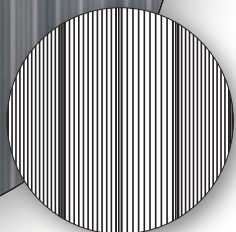

DN
Rombi



Grand Polaris

Stampa digitale
su vetro piano

Grand Polaris

DM
Wave

Grand Polaris



Finitura pannelli

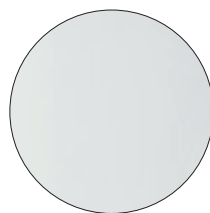

TR
Trasparente

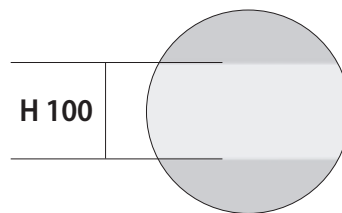

RF
Trasparente con fascia satinata H. 100 cm.

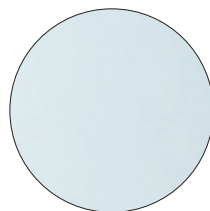

AS
Satinato Acqua



Trattamento anticalcare di serie compreso nel prezzo

Profili in alluminio

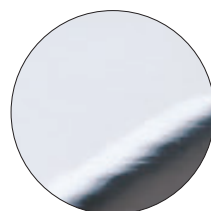

ULU
Brillantato cromo

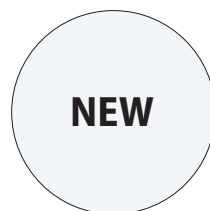

L91
Bianco opaco

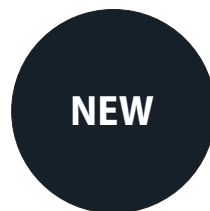

L96
Nero opaco

Angolo

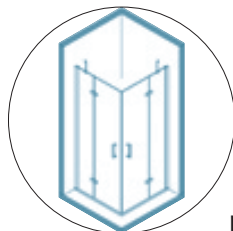

p. 110

Parete fissa

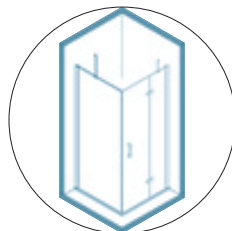

p. 112

Porta

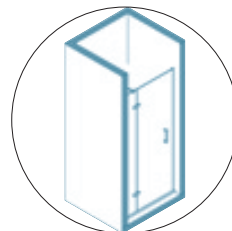

p. 114

Grand Polaris

5

anni di
GARANZIA

195

cm

6

mm



Finitura pannelli

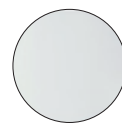

TR Trasparente

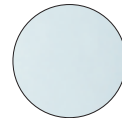

AS Satinato Acqua

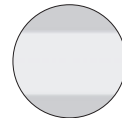

RF Trasparente con fascia
satinata H 100 cm.

Profili in alluminio



ULU Brillantato cromo

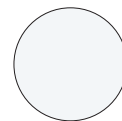

L91 Bianco opaco



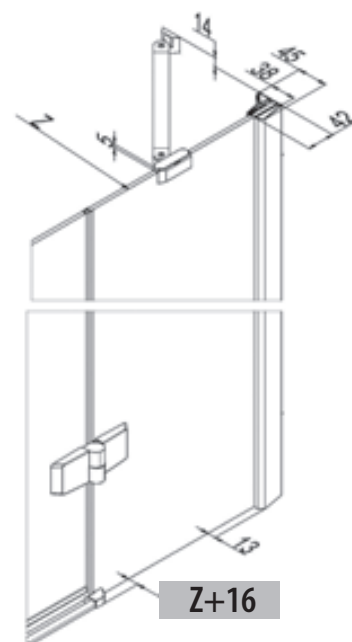
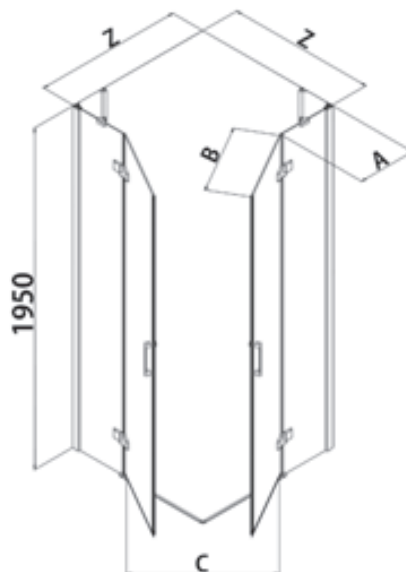
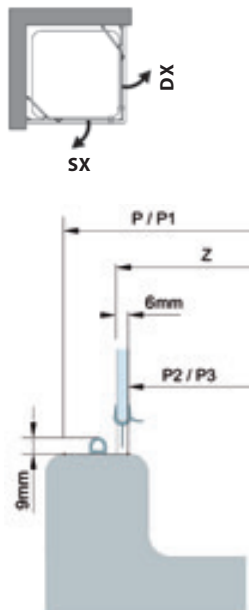

L96 Nero opaco

Angolo a quattro ante, due pareti fisse e due battenti apribili verso l'esterno.
Apertura ad ante ripiegabili grazie a cerniere sollevabili e snodate a 180° verso l'esterno.



Le dimensioni sono espresse in mm.

Z [cm]	Cod.	ingombro max Z+1,6 [cm]	A [cm]	B [cm]	C [cm]	 [dm³]	 [kg]	 [n°]	Pannelli	L91 [€]	L96 [€]	ULU [€]
65-67,5	B3705 [1 Lato]	66,6-69,1	23,3-25,8	41,7	56	73	26	1	TR	692	692	692
									AS	935	935	935
									RF	796	796	796
67,5-70	B3706 [1 Lato]	69,1-71,6	23,3-25,8	44,2	60	76	26,5	1	TR	697	697	697
									AS	941	941	941
									RF	802	802	802
70,5-73	B3707 [1 Lato]	72,1-74,6	24,8-27,3	45,7	62	74	27,5	1	TR	702	702	702
									AS	948	948	948
									RF	808	808	808
73-75,5	B3708 [1 Lato]	74,6-77,1	24,8-27,3	45,7	62	80	28,5	1	TR	708	708	708
									AS	956	956	956
									RF	815	815	815
76,5-79	B3709 [1 Lato]	78,1-80,6	27,3-29,8	51,7	70	85	29	1	TR	713	713	713
									AS	963	963	963
									RF	820	820	820
79-81,5	B3710 [1 Lato]	80,6-83,1	27,3-29,8	51,7	70	84	30	1	TR	718	718	718
									AS	970	970	970
									RF	826	826	826
82-84,5	B3711 [1 Lato]	83,6-86,1	30,3-32,8	51,7	70	83	30,5	1	TR	725	725	725
									AS	979	979	979
									RF	834	834	834
85-87,5	B3712 [1 Lato]	86,6-89,1	33,3-35,8	51,7	70	89	31	1	TR	729	729	729
									AS	985	985	985
									RF	839	839	839
95-97,5	B3713 [1 Lato]	96,6-99,1	37,3-39,8	57,7	79	99	34	1	TR	741	741	741
									AS	1001	1001	1001
									RF	853	853	853
105-107,5	B3714 [1 Lato]	106,6-109,1	47,2-49,7	57,7	79	99	37	1	TR	753	753	753
									AS	1017	1017	1017
									RF	866	866	866
115-117,5	B3715 [1 Lato]	116,6-119,1	57,3-59,8	57,7	79	114	39	1	TR	765	765	765
									AS	1033	1033	1033
									RF	880	880	880

Tempi di consegna

1-2 settimane

2-3 settimane

3-4 settimane

N.B. I valori della tabella prezzi si riferiscono ad un singolo lato: sommare l'importo dei due codici della misura desiderata per ottenere il prezzo totale di una doccia ad angolo quadrata o rettangolare. Apertura determinata con due lati della stessa misura.

Prodotti Speciali	Misure limite	I [€]	II [€]	III [€]
	H max 210 cm - L max 120 cm - min 50 cm	105	135	165

Modulo di richiesta disponibile on-line sul sito: www.samo.it/it/prodotti-speciali - In caso di annullamento dopo l'accettazione, sarà addebitato il costo totale dell'ordine.

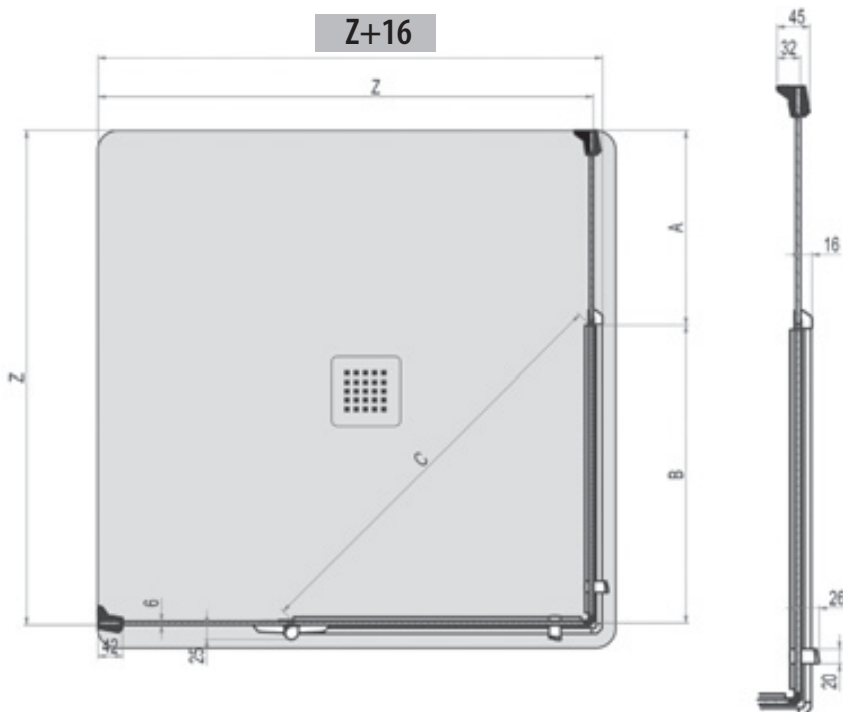

Inquadrare il QR code per collegarsi alla pagina del sito www.samo.it per vedere altre combinazioni di pannelli e vetri

Le dimensioni sono espresse in mm.

Grand Polaris

5
anni di
GARANZIA

195
cm

6
mm

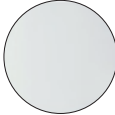
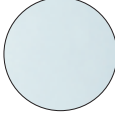
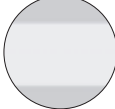

Finitura pannelli

-  TR Trasparente
-  AS Satinato Acqua
-  RF Trasparente con fascia satinata H 100 cm.

Profili in alluminio

-  ULU Brillantato cromo
-  L91 Bianco opaco
-  L96 Nero opaco

Parete fissa per abbinamenti, è possibile formare box a 2 lati con 1 lato battente ad angolo, anche misure rettangolari.

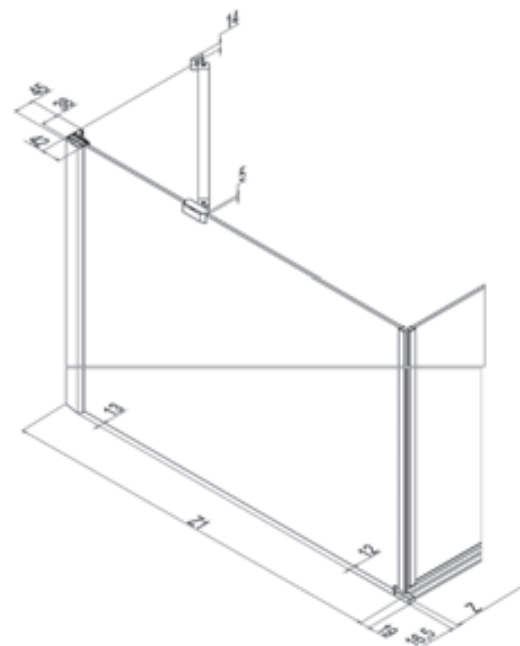
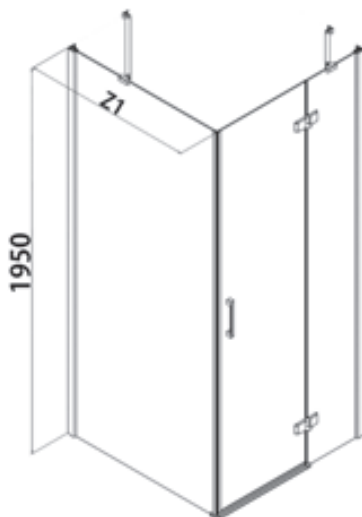
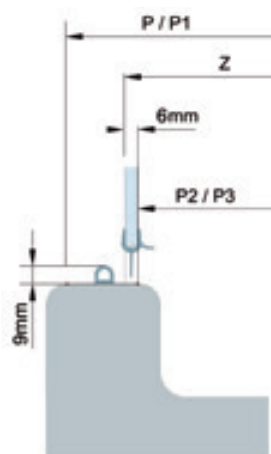

Le dimensioni sono espresse in mm.

Z [cm]	Cod.	Ingombro max Z1 + 2,2 [cm]	A [cm]	B [cm]	[dm³]	[kg]	[n°]	Pannelli	L91 [€]	L96 [€]	ULU [€]
64-66,5	B3750	62,2-68,7	//	//	99	29	1	TR	607	607	607
								AS	820	820	820
								RF	699	699	699
66,5-69	B3751	68,7-71,2	//	//	101	29	1	TR	612	612	612
								AS	827	827	827
								RF	704	704	704
69-71,5	B3752	71,2-73,7	//	//	102	29	1	TR	615	615	615
								AS	831	831	831
								RF	708	708	708
71,5-74	B3753	73,7-76,2	//	//	112	29	1	TR	619	619	619
								AS	836	836	836
								RF	712	712	712
74-76,5	B3754	76,2-78,7	//	//	115	30	1	TR	622	622	622
								AS	840	840	840
								RF	716	716	716
76,5-79	B3755	78,7-81,2	//	//	117	31	1	TR	625	625	625
								AS	844	844	844
								RF	719	719	719
79-81,5	B3756	81,2-83,7	//	//	120	36	1	TR	631	631	631
								AS	852	852	852
								RF	726	726	726
81,5-84	B3757	83,7-86,2	//	//	105	35	1	TR	633	633	633
								AS	855	855	855
								RF	728	728	728
84-86,5	B3758	86,2-88,7	//	//	107	34	1	TR	636	636	636
								AS	859	859	859
								RF	732	732	732
86,5-89	B3759	88,7-91,2	//	//	109	35	1	TR	641	641	641
								AS	866	866	866
								RF	738	738	738
89-91,5	B3760	91,2-93,7	//	//	113	36	1	TR	644	644	644
								AS	870	870	870
								RF	741	741	741

Tempi di consegna

1-2 settimane

2-3 settimane

3-4 settimane

Cod.	Descrizione	L91 [€]	L96 [€]	ULU [€]
KT3700	Kit di sostegno optional per la versione ad angolo	148	148	148

Prodotti Speciali	Misure limite	I [€]	II [€]	III [€]
	H max 210 cm - min 160 cm - L max 120 cm - min 20 cm	110	120	150

Modulo di richiesta disponibile on-line sul sito: www.samo.it/it/prodotti-speciali - In caso di annullamento dopo l'accettazione, sarà addebitato il costo totale dell'ordine.

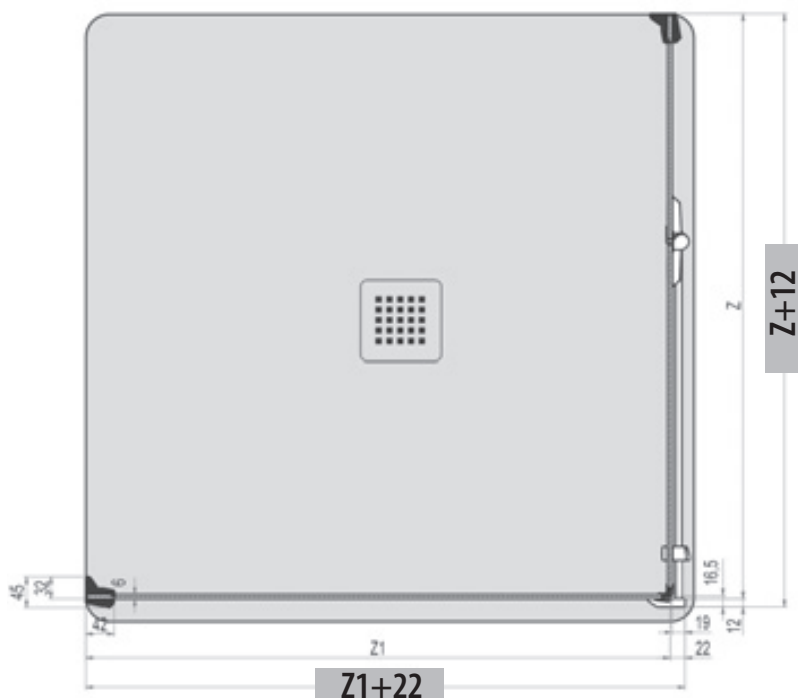

Inquadrare il QR code per collegarsi alla pagina del sito www.samo.it per vedere altre combinazioni di pannelli e vetri

Grand Polaris

5

anni di
GARANZIA

195

cm

6

mm



Finitura pannelli

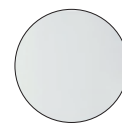

TR Trasparente

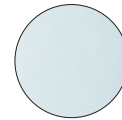

AS Satinato Acqua

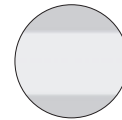

RF Trasparente con fascia
satinata H 100 cm.

Profili in alluminio



ULU Brillantato cromo

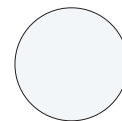

L91 Bianco opaco



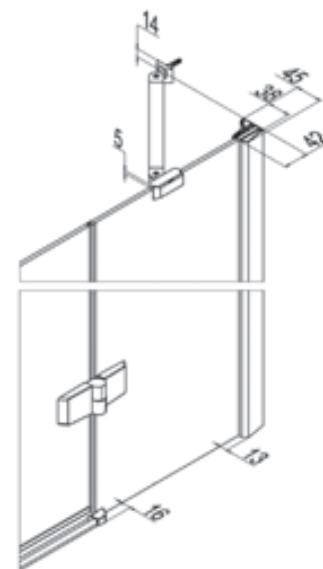
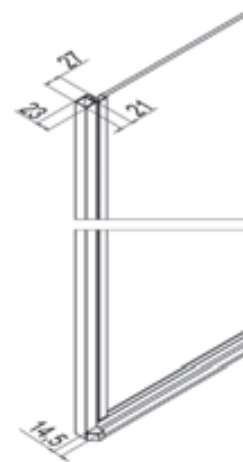
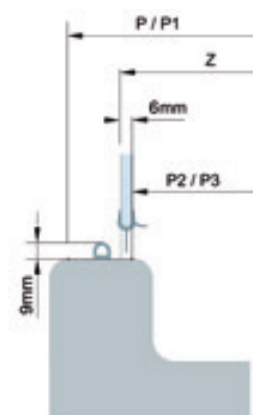
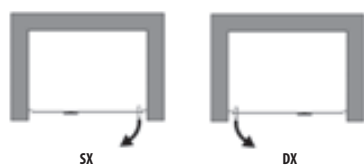

L96 Nero opaco

Porta ad un'anta a battente, una parete fissa e una battente apribile verso l'esterno.
Apertura ad anta ripiegabile grazie a cerniere snodate a 180° verso l'esterno.



Le dimensioni sono espresse in mm.

Z [cm]	Cod.	A [cm]	B [cm]	C [cm]	 [dm ³]	 [kg]	 [n°]	Pannelli	L91 [€]	L96 [€]	ULU [€]
62-65,5	B3730	19,8-22,3	39,9	39	70	26	1	TR	705	705	705
								AS	952	952	952
								RF	811	811	811
65,5-69	B3731	23,3-25,8	39,9	39	76	27,5	1	TR	713	713	713
								AS	963	963	963
								RF	820	820	820
69-72,5	B3732	23,3-25,8	43,4	42	76	29	1	TR	722	722	722
								AS	975	975	975
								RF	831	831	831
72,5-76	B3733	26,8-29,3	43,4	42	82	29,5	1	TR	730	730	730
								AS	986	986	986
								RF	840	840	840
76-79,5	B3734	26,8-29,3	46,9	46	84	30	1	TR	739	739	739
								AS	998	998	998
								RF	850	850	850
79,5-83	B3735	30,3-32,8	46,9	46	84	30,5	1	TR	742	742	742
								AS	1002	1002	1002
								RF	854	854	854
83-86,5	B3736	30,3-32,8	50,4	49	89	31	1	TR	744	744	744
								AS	1005	1005	1005
								RF	856	856	856
86,5-90	B3737	33,3-35,8	50,9	49	89	32,5	1	TR	752	752	752
								AS	1016	1016	1016
								RF	865	865	865
90-93,5	B3738	33,3-35,8	54,5	53	95	34	1	TR	760	760	760
								AS	1026	1026	1026
								RF	874	874	874
93,5-97	B3739	37,3-39,8	53,9	53	99	35	1	TR	768	768	768
								AS	1037	1037	1037
								RF	884	884	884
97-100,5	B3740	37,3-39,8	57,4	56	105	36	1	TR	775	775	775
								AS	1047	1047	1047
								RF	892	892	892
100,5-104	B3741	40,8-43,3	57,4	56	111	36,5	1	TR	783	783	783
								AS	1058	1058	1058
								RF	901	901	901
104-107,5	B3742	40,8-43,3	60,9	60	111	37,5	1	TR	783	783	783
								AS	1058	1058	1058
								RF	901	901	901
107,5-111	B3743	40,8-43,3	64,4	63	111	38	1	TR	791	791	791
								AS	1068	1068	1068
								RF	910	910	910
111-114,5	B3744	43,3-46,8	64,4	63	111	36	1	TR	799	799	799
								AS	1079	1079	1079
								RF	919	919	919
114,5-118	B3745	47,2-49,7	65	64	115	40	1	TR	806	806	806
								AS	1089	1089	1089
								RF	927	927	927
118-121,5	B3746	47,2-49,7	68,5	67	119	42	1	TR	814	814	814
								AS	1099	1099	1099
								RF	937	937	937

Tempi di consegna	1-2 settimane	2-3 settimane	3-4 settimane
-------------------	---------------	---------------	---------------

Prodotti Speciali	Misure limite	I [€]	II [€]	III [€]
	H max 210 cm - L min 60 cm - max 140 cm	115	135	150

Modulo di richiesta disponibile on-line sul sito: www.samo.it/it/prodotti-speciali - In caso di annullamento dopo l'accettazione, sarà addebitato il costo totale dell'ordine.

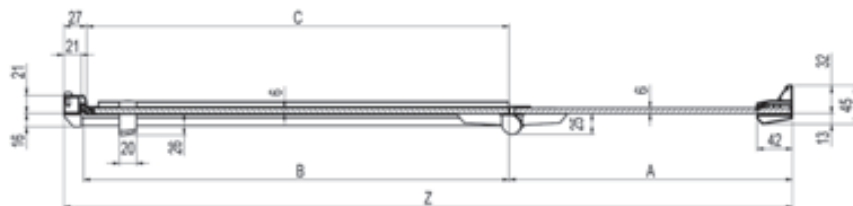

Le dimensioni sono espresse in mm.



Inquadrare il QR code per collegarsi alla pagina del sito www.samo.it per vedere altre combinazioni di pannelli e vetri





Acrux

La nostra doccia
più glamour

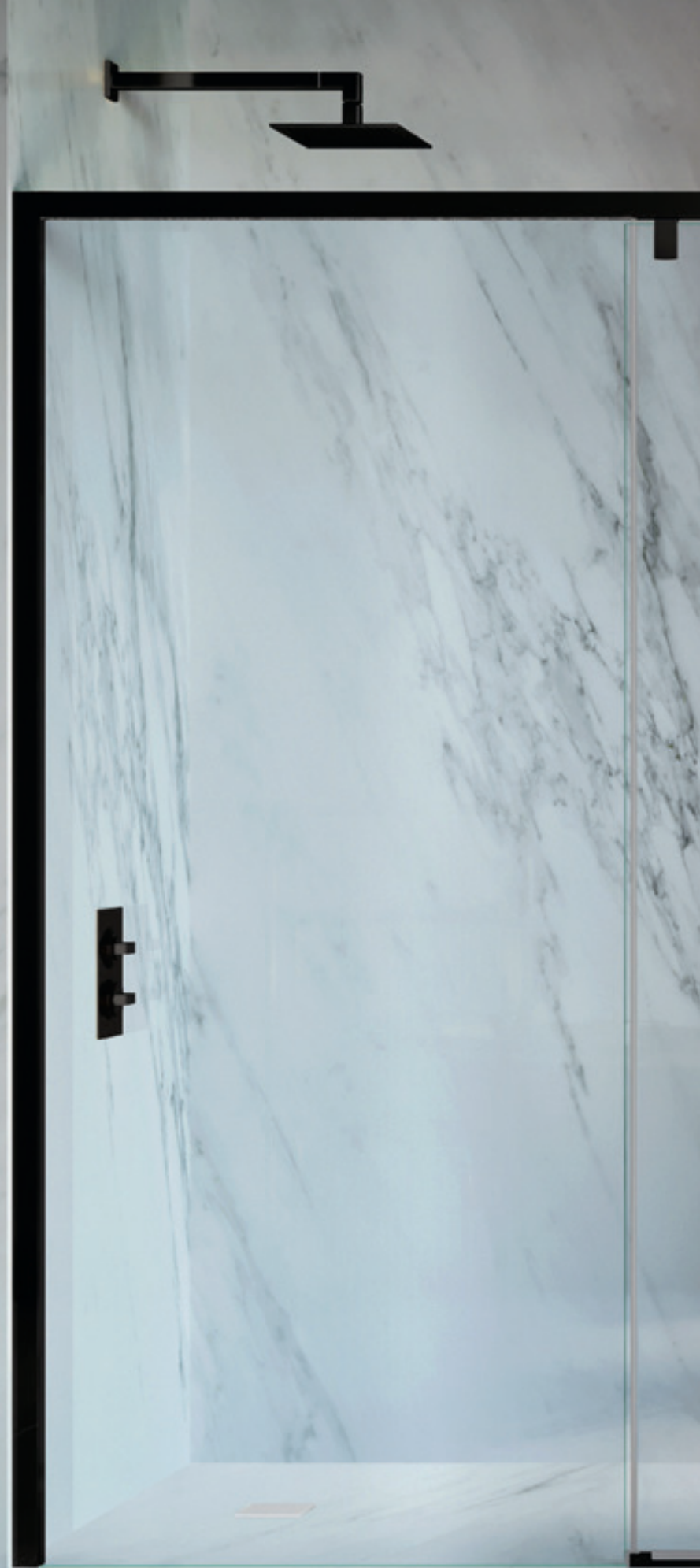



AcruX





Acrux

L90
artico opaco



L92
sailor blue opaco



L95
grigio opaco



L96
nero opaco



L98
sabbia opaco



L99
tortora opaco

PLUS DI PRODOTTO

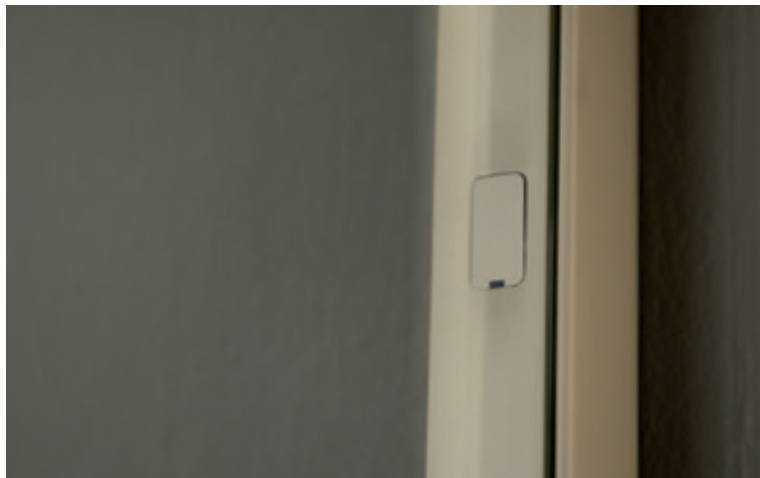

- H 200 cm – V 6/8 mm
- 2 cm di regolazione del fuorisquadra
- Regolazione millimetrica dei profili a muro
- Soft closing sulle porte scorrevoli, compreso nel prezzo
- Sgancio anta scorrevole per facilitare la pulizia
- Cerniere e guarnizioni a filo interno vetro
- Apertura interno-esterno su porte battenti pivot
- Finitura vetro specchio (solo su pareti e ante fisse)
- Interasse maniglia 580 mm
- Anticalcare compreso nel prezzo
- Stampa digitale disponibile su tutti i vetri piani TR e TG



PLUS DI PRODOTTO

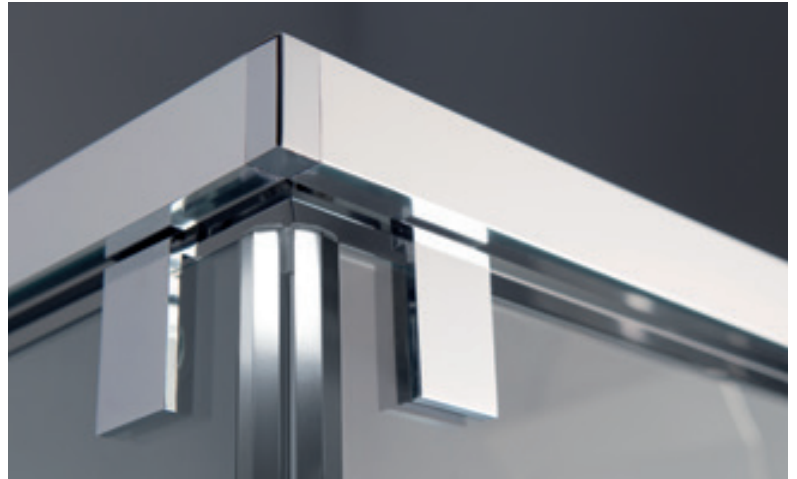

ACTUX



Soft closing sulle porte scorrevoli, compreso nel prezzo

Stampa digitale
disponibile su tutti vetri piani TR e TG



DD
Brezza

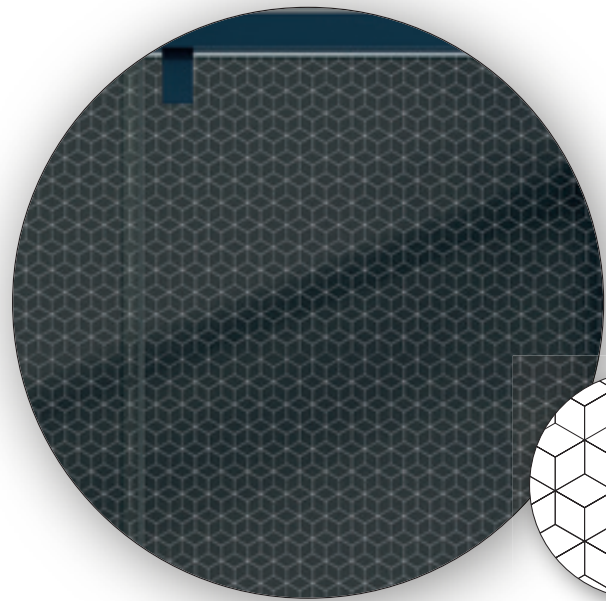
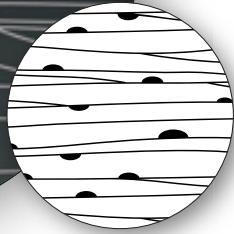

DH
Cubix

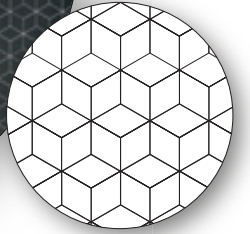

DI
Fronda

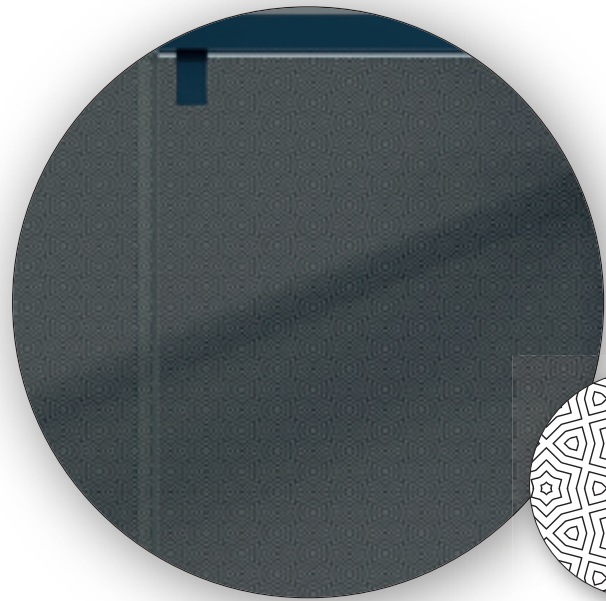

DK
Exagon

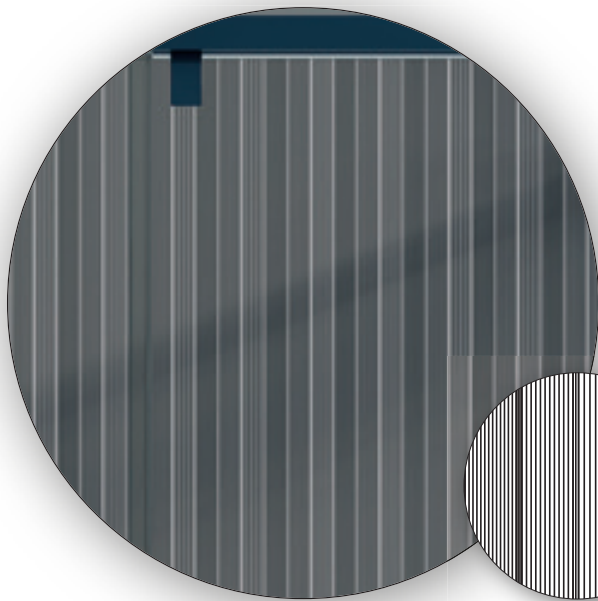

DM
Wave

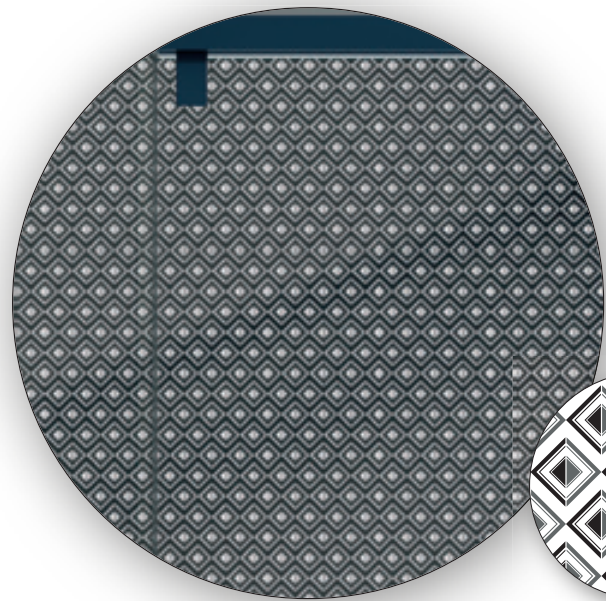
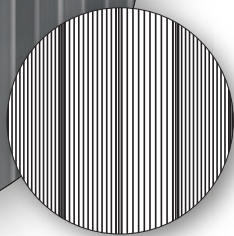

DN
Rombi



Acrux

Stampa
digitale

DN
Rombi

Acrux

Acrux



Finitura pannelli

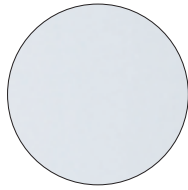

TR
Trasparente

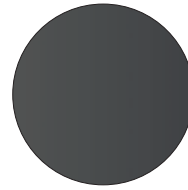

TG
Trasparente

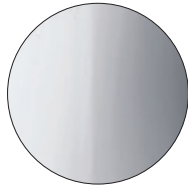

SY
Vetro a specchio

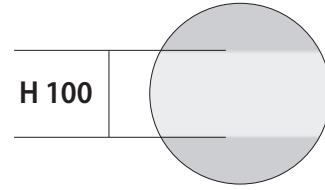

RF
Trasparente con fascia satinata H. 100 cm.

Profili in alluminio

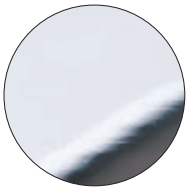

ULU
Brillantato cromo

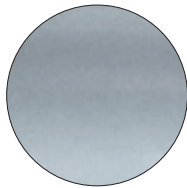

SAR
Satinato argento

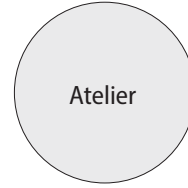

L90
Artic opaco

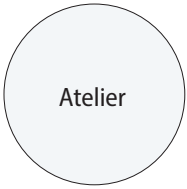

L91
Bianco opaco



L92
Sailor blue opaco

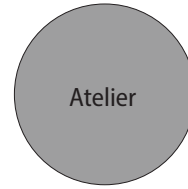

L95
Grigio opaco



L96
Nero opaco

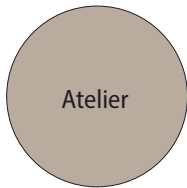

L98
Sabbia opaco

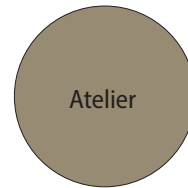

L99
Tortora opaco

Actux

Angolo

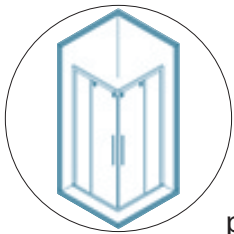

p. 126

Porta



p. 128

Parete fissa

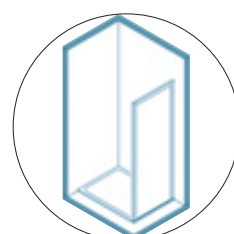

p. 136

Porta

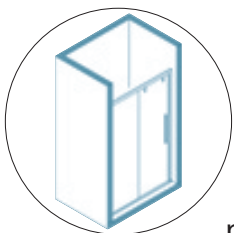

p. 130

Porta

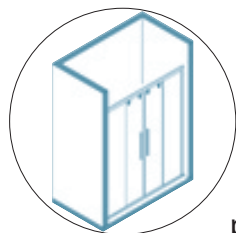

p. 132

Porta

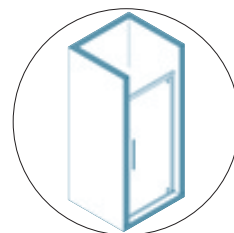

p. 134

5

anni di
GARANZIA



200
cm

8
mm

6
mm

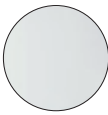

Finitura pannelli

-  TR
Trasparente
-  TG
Trasparente grigio
-  RF
Trasparente con fascia satinata
H 100 cm.
-  SY
Vetro a specchio

Profili in alluminio

-  ULU
Brillantato cromo
-  SAR
Satinato Argento
-  L90
Artic opaco
-  L91
Bianco opaco
-  L92
Sailor blue opaco
-  L95
Grigio opaco
-  L96
Nero opaco
-  L98
Sabbia opaco
-  L99
Tortora opaco

Angolo a quattro ante, apertura ad ante scorrevoli, due fisse con pannelli da 6 mm. e due apribili da 8 mm. Profili superiori e verticali portanti, assenza di quelli inferiori. Sgancio rapido delle ante per agevolare la pulizia. **Chiusura rallentata delle ante con sistema Soft Closing.**

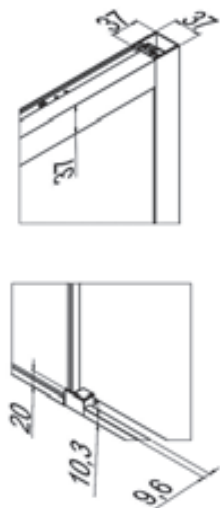
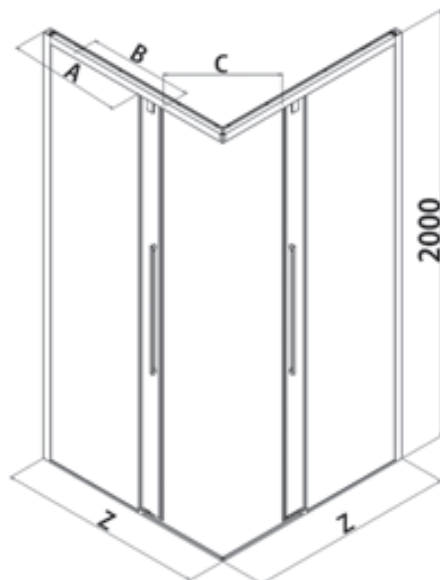
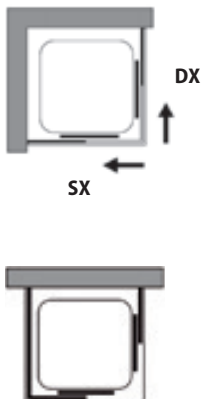

Le dimensioni sono espresse in mm.

Z [cm]	Cod.	A [cm]	B [cm]	C [cm]	 [dm³]	 [kg]	 [n°]	Pannelli	SAR [€]	ULU [€]	L96 [€]	ATELIER [€]
67-69	B8816 [1 Lato]	32	33,3	36	80	29	1	TR	830	830	830	830
								TG	955	955	955	955
								RF	955	955	955	955
								SY	1162	1162	1162	1162
72-74	B8817 [1 Lato]	34,5	35,8	40	83	32	1	TR	846	846	846	846
								TG	973	973	973	973
								RF	973	973	973	973
								SY	1185	1185	1185	1185
77-79	B8818 [1 Lato]	37	38,3	43	87	34	1	TR	865	865	865	865
								TG	995	995	995	995
								RF	995	995	995	995
								SY	1211	1211	1211	1211
87-89	B8820 [1 Lato]	42	43,3	50	97	37	1	TR	896	896	896	896
								TG	1031	1031	1031	1031
								RF	1031	1031	1031	1031
								SY	1255	1255	1255	1255
97-99	B8821 [1 Lato]	52	43,3	51	101	40	1	TR	925	925	925	925
								TG	1064	1064	1064	1064
								RF	1064	1064	1064	1064
								SY	1295	1295	1295	1295
107-109	B8832 [1 Lato]	62	43,3	51	106	43	1	TR	968	968	968	968
								TG	1114	1114	1114	1114
								RF	1114	1114	1114	1114
								SY	1356	1356	1356	1356
117-119	B8833 [1 Lato]	72	43,3	51	123	46	1	TR	1002	1002	1002	1002
								TG	1153	1153	1153	1153
								RF	1153	1153	1153	1153
								SY	1403	1403	1403	1403

Tempi di consegna

1-2 settimane

2-3 settimane

3-4 settimane

N.B. I valori della tabella prezzi si riferiscono ad un singolo lato: sommare l'importo dei due codici della misura desiderata per ottenere il prezzo totale di una doccia ad angolo quadrata o rettangolare. Apertura determinata con due lati della stessa misura. La maniglia, gli scorrimenti, lo sgancio anta e i tappi di copertura sono in finitura CRO solo nelle versioni ULU e SAR. ATELIER: L90_L91_L92_L95_L98_L99

Prodotti Speciali	Misure limite	I [€]	II [€]	III [€]
	H max 210 cm / L max 120 cm - min 60 cm	135	150	165

Modulo di richiesta disponibile on-line sul sito: www.samo.it/it/prodotti-speciali - In caso di annullamento dopo l'accettazione, sarà addebitato il costo totale dell'ordine.



SY



Trattamento anticalcare di serie compreso nel prezzo



Inquadrare il QR code per collegarsi alla pagina del sito www.samo.it per vedere altre combinazioni di pannelli e vetri

Acrux

5
anni di
GARANZIA



200
cm

8
mm

6
mm

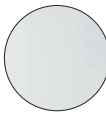

Finitura pannelli

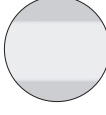
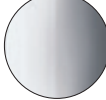
-  TR
Trasparente
-  TG
Trasparente grigio
-  RF
Trasparente con fascia satinata
H 100 cm.
-  SY
Vetro a specchio



Profili in alluminio

-  ULU
Brillantato cromo
-  SAR
Satinato Argento
-  L90
Artic opaco
-  L91
Bianco opaco
-  L92
Sailor blue opaco
-  L95
Grigio opaco
-  L96
Nero opaco
-  L98
Sabbia opaco
-  L99
Tortora opaco

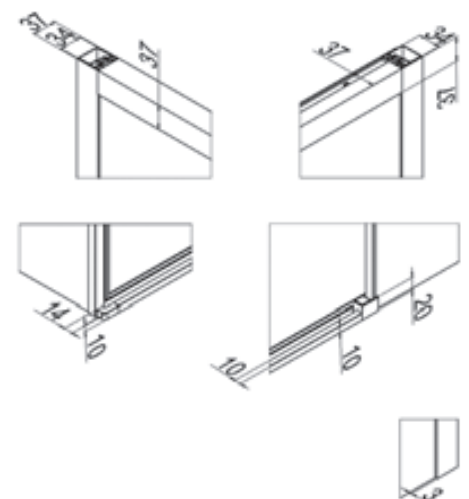
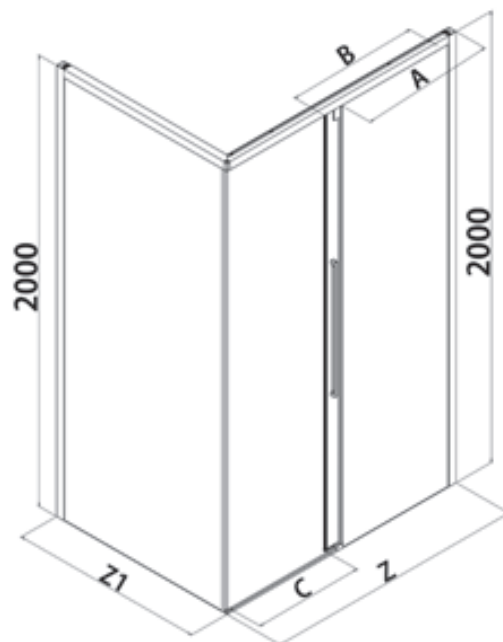
Porta scorrevole a due ante con parete fissa. Apertura laterale ad anta scorrevole, una fissa da 6 mm. ed una apribile da 8 mm.
Porta scorrevole installabile solo con parete fissa dedicata. Non è possibile l'installazione a nicchia.
Sgancio rapido dell'anta per agevolare la pulizia. Apertura-chiusura rallentata dell'anta con sistema Soft Closing.



Le dimensioni sono espresse in mm.

Z [cm]	Cod.	A [cm]	B [cm]	C [cm]	 [dm³]	 [kg]	 [n°]	Pannelli	SAR [€]	ULU [€]	L96 [€]	ATELIER [€]
97-99	B8880	49	49	40	150	42	1	TR	1007	1007	1007	1007
								TG	1159	1159	1159	1159
								RF	1159	1159	1159	1159
								SY	1410	1410	1410	1410
107-109	B8881	54	54	45	150	47	1	TR	1049	1049	1049	1049
								TG	1207	1207	1207	1207
								RF	1207	1207	1207	1207
								SY	1469	1469	1469	1469
117-119	B8882	59	59	50	170	51	1	TR	1090	1090	1090	1090
								TG	1254	1254	1254	1254
								RF	1254	1254	1254	1254
								SY	1526	1526	1526	1526
127-129	B8883	64	64	55	200	56	2	TR	1137	1137	1137	1137
								TG	1308	1308	1308	1308
								RF	1308	1308	1308	1308
								SY	1592	1592	1592	1592
137-139	B8884	69	69	60	240	56	2	TR	1184	1184	1184	1184
								TG	1362	1362	1362	1362
								RF	1362	1362	1362	1362
								SY	1658	1658	1658	1658
147-149	B8885	74	74	65	250	61	2	TR	1232	1232	1232	1232
								TG	1417	1417	1417	1417
								RF	1417	1417	1417	1417
								SY	1725	1725	1725	1725
157-159	B8886	79	79	70	260	65	2	TR	1286	1286	1286	1286
								TG	1479	1479	1479	1479
								RF	1479	1479	1479	1479
								SY	1801	1801	1801	1801
167-169	B8887	89	79	70	260	69	2	TR	1337	1337	1337	1337
								TG	1538	1538	1538	1538
								RF	1538	1538	1538	1538
								SY	1872	1872	1872	1872
177-179	B8888	99	79	70	430	72	2	TR	1394	1394	1394	1394
								TG	1604	1604	1604	1604
								RF	1604	1604	1604	1604
								SY	1952	1952	1952	1952

ACTUX

Parete fissa dedicata per porta scorrevole a due ante



Porta scorrevole installabile solo con parete fissa dedicata. Non è possibile l'installazione in nicchia.

67-69	B8892	//	//	//	150	42	1	TR	411	411	411	411
								TG	473	473	473	473
								RF	473	473	473	473
								SY	576	576	576	576
70-72	B8893	//	//	//	150	47	1	TR	427	427	427	427
								TG	492	492	492	492
								RF	492	492	492	492
								SY	598	598	598	598
72-74	B8894	//	//	//	170	51	1	TR	444	444	444	444
								TG	511	511	511	511
								RF	511	511	511	511
								SY	622	622	622	622
77-79	B8895	//	//	//	200	56	1	TR	461	461	461	461
								TG	531	531	531	531
								RF	531	531	531	531
								SY	646	646	646	646
87-89	B8896	//	//	//	240	56	1	TR	479	479	479	479
								TG	551	551	551	551
								RF	551	551	551	551
								SY	671	671	671	671
97-99	B8897	//	//	//	250	61	1	TR	499	499	499	499
								TG	574	574	574	574
								RF	574	574	574	574
								SY	699	699	699	699

Tempi di consegna

1-2 settimane

2-3 settimane

3-4 settimane

Prodotti Speciali	Misure limite	I [€]	II [€]	III [€]
Porta scorrevole a due ante	H max 210 cm / L max 200 cm - min 90 cm	185	230	285
Parete fissa	H max 210 cm / L max 120 cm - min 20 cm	95	100	120

Modulo di richiesta disponibile on-line sul sito: www.samo.it/it/prodotti-speciali - In caso di annullamento dopo l'accettazione, sarà addebitato il costo totale dell'ordine.



Inquadrare il QR code per collegarsi alla pagina del sito www.samo.it per vedere altre combinazioni di pannelli e vetri



Tattamento anticallcare di serie compreso nel prezzo

5

anni di
GARANZIA



200
cm

8
mm

6
mm

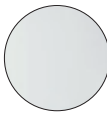

Finitura pannelli

-  TR
Trasparente
-  TG
Trasparente grigio
-  RF
Trasparente con fascia satinata
H 100 cm.
-  SY
Vetro a specchio

Profili in alluminio

-  ULU
Brillantato cromo
-  SAR
Satinato Argento
-  L90
Artico opaco
-  L91
Bianco opaco
-  L92
Sailor blue opaco
-  L95
Grigio opaco
-  L96
Nero opaco
-  L98
Sabbia opaco
-  L99
Tortora opaco

Porta scorrevole a due ante. Apertura laterale ad anta scorrevole, una fissa da 6 mm. ed una apribile da 8 mm. Profili superiori e verticali portanti, assenza di quelli inferiori. Sgancio rapido dell'anta per agevolare la pulizia. **Apertura-chiusura rallentata dell'anta con sistema Soft Closing.**





SX

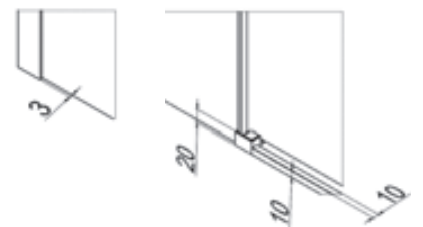
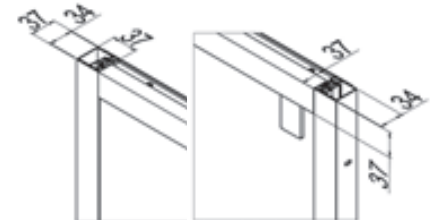
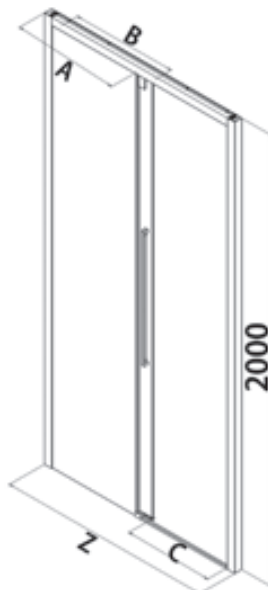

DX



Le dimensioni sono espresse in mm.

Z [cm]	Cod.	A [cm]	B [cm]	C [cm]	 [dm³]	 [kg]	 [n°]	Pannelli	SAR [€]	ULU [€]	L96 [€]	ATELIER [€]
97-101	B8812	47	48	40	150	42	1	TR	1007	1007	1007	1007
								TG	1159	1159	1159	1159
								RF	1159	1159	1159	1159
								SY	1410	1410	1410	1410
107-111	B8813	52	53	45	150	47	1	TR	1049	1049	1049	1049
								TG	1207	1207	1207	1207
								RF	1207	1207	1207	1207
								SY	1469	1469	1469	1469
117-121	B8814	57	58	50	170	51	1	TR	1090	1090	1090	1090
								TG	1254	1254	1254	1254
								RF	1254	1254	1254	1254
								SY	1526	1526	1526	1526
127-131	B8815	62	63	55	200	56	2	TR	1137	1137	1137	1137
								TG	1308	1308	1308	1308
								RF	1308	1308	1308	1308
								SY	1592	1592	1592	1592
137-141	B8842	67	68	60	240	56	2	TR	1184	1184	1184	1184
								TG	1362	1362	1362	1362
								RF	1362	1362	1362	1362
								SY	1658	1658	1658	1658
147-151	B8844	87	78	65	250	61	2	TR	1232	1232	1232	1232
								TG	1417	1417	1417	1417
								RF	1417	1417	1417	1417
								SY	1725	1725	1725	1725
157-161	B8845	72	73	70	260	65	2	TR	1286	1286	1286	1286
								TG	1479	1479	1479	1479
								RF	1479	1479	1479	1479
								SY	1801	1801	1801	1801
167-171	B8843	77	78	70	260	69	2	TR	1337	1337	1337	1337
								TG	1538	1538	1538	1538
								RF	1538	1538	1538	1538
								SY	1872	1872	1872	1872
177-181	B8846	97	78	70	430	72	2	TR	1394	1394	1394	1394
								TG	1604	1604	1604	1604
								RF	1604	1604	1604	1604
								SY	1952	1952	1952	1952

Tempi di consegna	1-2 settimane	2-3 settimane	3-4 settimane
-------------------	---------------	---------------	---------------

Prodotti Speciali	Misure limite	I [€]	II [€]	III [€]
	H max 210 cm / L max 200 cm - min 90 cm	185	230	285

Modulo di richiesta disponibile on-line sul sito: www.samo.it/it/prodotti-speciali - In caso di annullamento dopo l'accettazione, sarà addebitato il costo totale dell'ordine.

Parete fissa per abbinamenti (pag. 136-7)

Cod.	B8822	B8823	B8824	B8825	B8826	B8827
Estensibilità [2 cm]	67-69	70-72	72-74	77-79	87-89	97-99



Trattamento anticalcare di serie compreso nel prezzo



Inquadrare il QR code per collegarsi alla pagina del sito www.samo.it per vedere altre combinazioni di pannelli e vetri

5
anni di
GARANZIA

200
cm

8
mm

6
mm



Finitura pannelli

-  TR
Trasparente
-  TG
Trasparente grigio
-  RF
Trasparente con fascia satinata
H 100 cm.
-  SY
Vetro a specchio



Profili in alluminio

-  ULU
Brillantato cromo
-  SAR
Satinato Argento
-  L90
Artico opaco
-  L91
Bianco opaco
-  L92
Sailor blue opaco
-  L95
Grigio opaco
-  L96
Nero opaco
-  L98
Sabbia opaco
-  L99
Tortora opaco

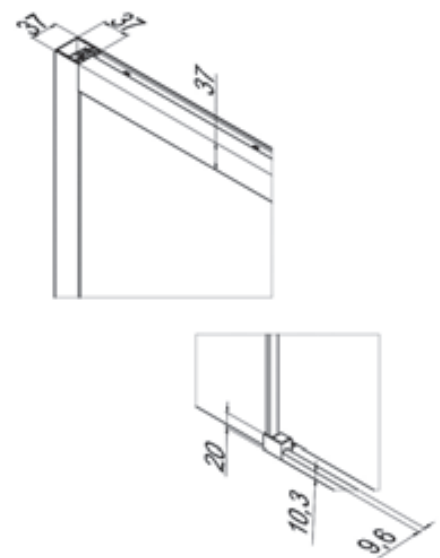
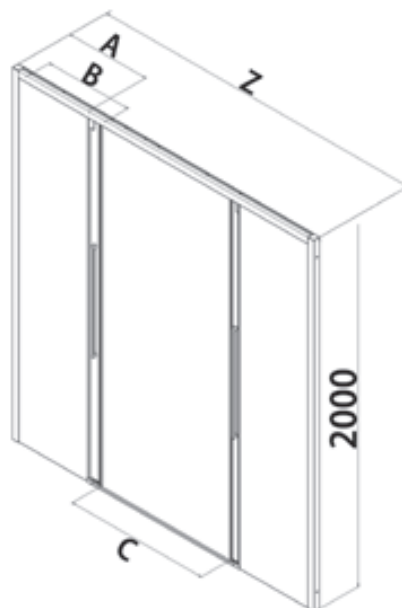
Porta scorrevole a quattro ante, con apertura centrale ad ante scorrevoli, due fisse da 6 mm. e due apribili da 8 mm. Profili superiori e verticali portanti, assenza di quelli inferiori. Sgancio rapido delle ante per agevolare la pulizia. **Apertura-chiusura rallentata dell'anta con sistema Soft Closing.**



Le dimensioni sono espresse in mm.

Z [cm]	Cod.	A [cm]	B [cm]	C [cm]	 [dm³]	 [kg]	 [n°]	Pannelli	SAR [€]	ULU [€]	L96 [€]	ATELIER [€]
157-161	B8852	42	39,2	61	150	62	2	TR	1819	1819	1819	1819
								TG	2092	2092	2092	2092
								RF	2092	2092	2092	2092
								SY	2547	2547	2547	2547
167-171	B8853	42	44,2	70	160	66	2	TR	1856	1856	1856	1856
								TG	2135	2135	2135	2135
								RF	2135	2135	2135	2135
								SY	2599	2599	2599	2599
177-181	B8854	42	48,9	70	170	70	2	TR	1893	1893	1893	1893
								TG	2177	2177	2177	2177
								RF	2177	2177	2177	2177
								SY	2651	2651	2651	2651
187-191	B8855	47	48,9	80	200	74	2	TR	1931	1931	1931	1931
								TG	2221	2221	2221	2221
								RF	2221	2221	2221	2221
								SY	2704	2704	2704	2704
197-201	B8856	52	48,9	83	200	80	2	TR	1970	1970	1970	1970
								TG	2266	2266	2266	2266
								RF	2266	2266	2266	2266
								SY	2758	2758	2758	2758

Tempi di consegna	1-2 settimane	2-3 settimane	3-4 settimane
-------------------	---------------	---------------	---------------

ATELIER: L90_L91_L92_L95_L98_L99. La maniglia, gli scorrimenti, lo sgancio anta e i tappi di copertura sono in finitura CRO solo nelle versioni ULU e SAR.

Prodotti Speciali	Misure limite	I [€]	II [€]	III [€]
	H max 210 cm / L max 250 cm - min 120 cm	200	250	300

Modulo di richiesta disponibile on-line sul sito: www.samo.it/it/prodotti-speciali - In caso di annullamento dopo l'accettazione, sarà addebitato il costo totale dell'ordine.

Parete fissa per abbinamenti (pag. 136-7)						
Cod.	B8822	B8823	B8824	B8825	B8826	B8827
Estensibilità [2 cm]	67-69	70-72	72-74	77-79	87-89	97-99



Tattamento anticalcare di serie compreso nel prezzo



Inquadrare il QR code per collegarsi alla pagina del sito www.samo.it per vedere altre combinazioni di pannelli e vetri

5

anni di
GARANZIA

200
cm

8
mm



Finitura pannelli

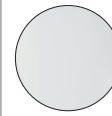

TR
Trasparente



TG
Trasparente grigio



RF
Trasparente con fascia satinata
H 100 cm.

Profili in alluminio



ULU
Brillantato cromo

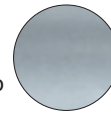

SAR
Satinato Argento

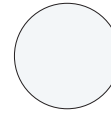

L90
Artic opaco

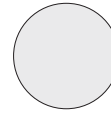

L91
Bianco opaco



L92
Sailor blue opaco

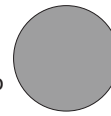

L95
Grigio opaco



L96
Nero opaco

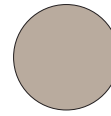

L98
Sabbia opaco

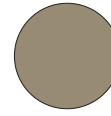

L99
Tortora opaco

Porta ad un'anta a battente pivot con apertura verso l'interno e verso l'esterno.
Profili superiori e verticali portanti, assenza di quelli inferiori.





SX

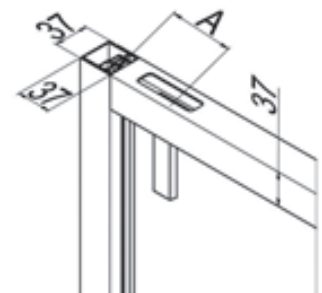

DX



Le dimensioni sono espresse in mm.

Z [cm]	Cod.	A [cm]	B [cm]	C [cm]	 [dm³]	 [kg]	 [n°]	Pannelli	SAR [€]	ULU [€]	L96 [€]	ATELIER [€]
67-71	B8801	5,4	51,2	53	120	31	1	TR	1093	1093	1093	1093
								TG	1257	1257	1257	1257
								RF	1257	1257	1257	1257
72-76	B8802	5,4	56,2	58	132	33	1	TR	1112	1112	1112	1112
								TG	1279	1279	1279	1279
								RF	1279	1279	1279	1279
77-81	B8803	5,4	61,2	63	132	36	1	TR	1129	1129	1129	1129
								TG	1299	1299	1299	1299
								RF	1299	1299	1299	1299
82-86	B8804	5,4	66,2	68	132	38	1	TR	1149	1149	1149	1149
								TG	1322	1322	1322	1322
								RF	1322	1322	1322	1322
87-91	B8805	5,4	71,2	73	132	40	1	TR	1170	1170	1170	1170
								TG	1346	1346	1346	1346
								RF	1346	1346	1346	1346
97-101	B8807	5,4	81,2	83	132	40	1	TR	1186	1186	1186	1186
								TG	1364	1364	1364	1364
								RF	1364	1364	1364	1364

Tempi di consegna	1-2 settimane	2-3 settimane	3-4 settimane
-------------------	---------------	---------------	---------------

ATELIER: L90_L91_L92_L95_L98_L99. La maniglia, gli scorrimenti, lo sgancio anta e i tappi di copertura sono in finitura CRO solo nelle versioni ULU e SAR.

Prodotti Speciali	Misure limite	I [€]	II [€]	III [€]
	H max 210 cm / L max 100 cm - min 60 cm	185	200	235

Modulo di richiesta disponibile on-line sul sito: www.samo.it/it/prodotti-speciali - In caso di annullamento dopo l'accettazione, sarà addebitato il costo totale dell'ordine.

Parete fissa per abbinamenti (pag. 136-7)

Cod.	B8822	B8823	B8824	B8825	B8826	B8827
Estensibilità [2 cm]	67-69	70-72	72-74	77-79	87-89	97-99



Trattamento anticalcare di serie compreso nel prezzo



Inquadrare il QR code per collegarsi alla pagina del sito www.samo.it per vedere altre combinazioni di pannelli e vetri

5



anni di
GARANZIA

200
cm

6
mm

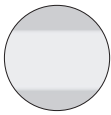

Finitura pannelli

-  TR
Trasparente
-  TG
Trasparente grigio
-  RF
Trasparente con fascia satinata
H 100 cm.
-  SY
Vetro a specchio

Profili in alluminio

-  ULU
Brillantato cromo
-  SAR
Satinato Argento
-  L90
Artic opaco
-  L91
Bianco opaco
-  L92
Sailor blue opaco
-  L95
Grigio opaco
-  L96
Nero opaco
-  L98
Sabbia opaco
-  L99
Tortora opaco

Parete fissa per abbinamenti, è possibile formare cabine doccia a due o tre lati, anche misure rettangolari. Profili superiori e verticali portanti, assenza di quelli inferiori. Non installabile singolarmente o come divisorio.





SX

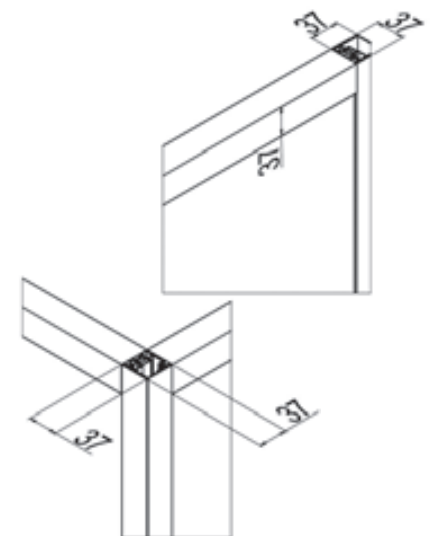
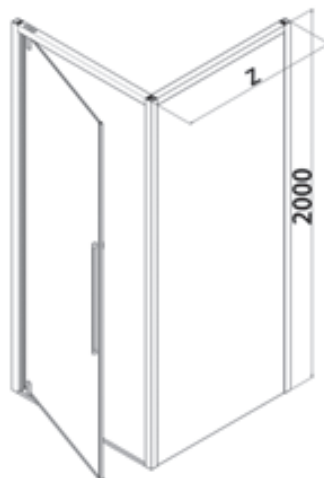

DX



Le dimensioni sono espresse in mm.

Z [cm]	Cod.	A [cm]	B [cm]	C [cm]	 [dm³]	 [kg]	 [n°]	Pannelli	SAR [€]	ULU [€]	L96 [€]	ATELIER [€]
67-69	B8822	//	//	//	99	24	1	TR	411	411	411	411
								TG	473	473	473	473
								RF	473	473	473	473
								SY	576	576	576	576
70-72	B8823	//	//	//	105	26	1	TR	427	427	427	427
								TG	492	492	492	492
								RF	492	492	492	492
								SY	598	598	598	598
72-74	B8824	//	//	//	113	27	1	TR	444	444	444	444
								TG	511	511	511	511
								RF	511	511	511	511
								SY	622	622	622	622
77-79	B8825	//	//	//	119	29	1	TR	461	461	461	461
								TG	531	531	531	531
								RF	531	531	531	531
								SY	646	646	646	646
87-89	B8826	//	//	//	124	30	1	TR	479	479	479	479
								TG	551	551	551	551
								RF	551	551	551	551
								SY	671	671	671	671
97-99	B8827	//	//	//	129	31	1	TR	499	499	499	499
								TG	574	574	574	574
								RF	574	574	574	574
								SY	699	699	699	699
Tempi di consegna						1-2 settimane		2-3 settimane		3-4 settimane		

ATELIER: L90_L91_L92_L95_L98_L99.

Prodotti Speciali	Misure limite	I [€]	II [€]	III [€]
	H max 210 cm / L max 120 cm - min 20 cm	95	100	120

Modulo di richiesta disponibile on-line sul sito: www.samo.it/it/prodotti-speciali - In caso di annullamento dopo l'accettazione, sarà addebitato il costo totale dell'ordine.



Trattamento anticalcare di serie compreso nel prezzo



Inquadrare il QR code per collegarsi alla pagina del sito www.samo.it per vedere altre combinazioni di pannelli e vetri

Europa SP





Europa SP





B7977ULUAS



B7990ULUST

PLUS DI PRODOTTO



- H 196,5 cm – V 6/8 mm
- Regolazione del fuorisquadra
- Ampiezza di gamma completa
- Copertura completa delle misure
- Sgancio anta scorrevole per facilitare la pulizia
- Soft closing in chiusura di serie
- Porte battenti ad apertura interna ed esterna
- Interasse maniglia 320 mm
- Anticalcare compreso nel prezzo
- Stampa digitale disponibile su tutti i vetri piani TR



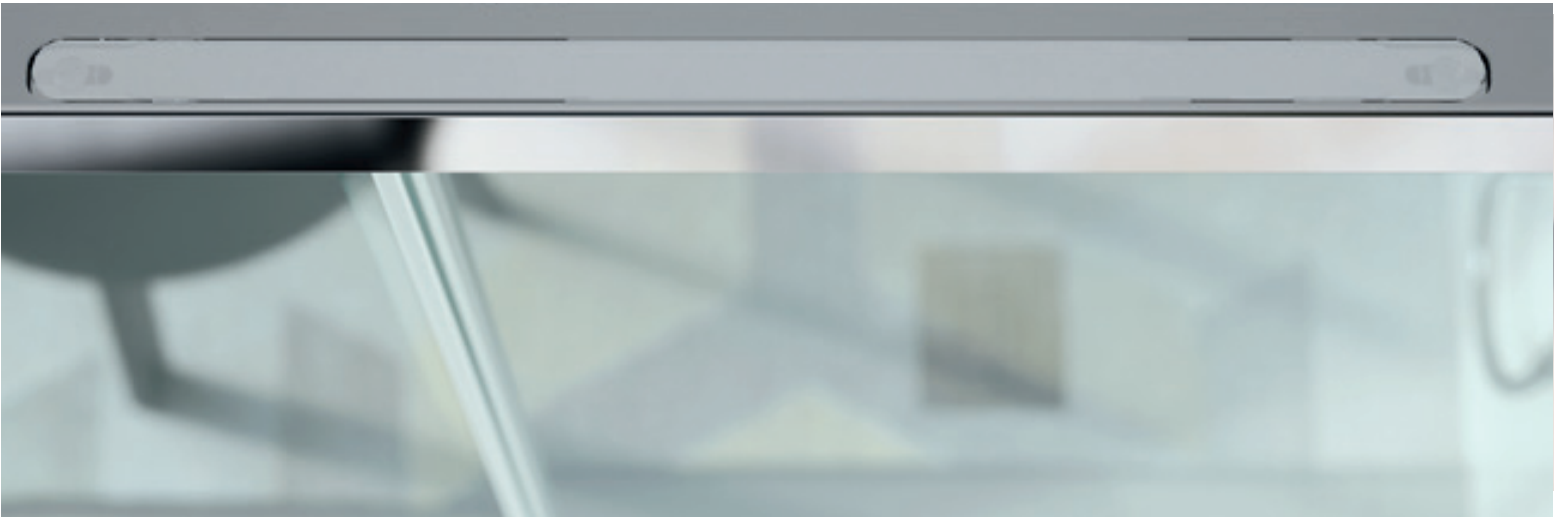

SOFT CLOSING, sistema rallentato in chiusura, di serie.



Maniglia interna optional, solo su richiesta:
RIC1418LUC: € 71

Europa SP



Finitura pannelli

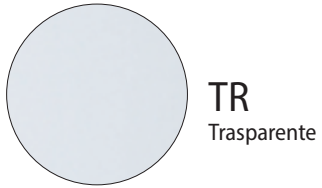

TR
Trasparente



ST
Stampato



AS
Satinato Acqua

Profili in alluminio



ULU
Brillantato cromo

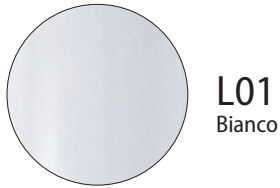

L01
Bianco



SAR
Satinato argento

Angolo

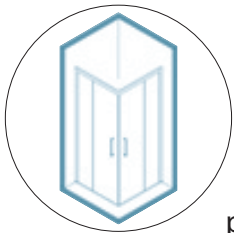

p. 146

Porta

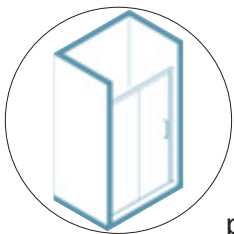

p. 148

Porta

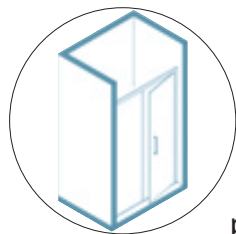

p. 150

Parete fissa

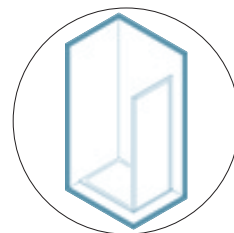

p. 154

Porta

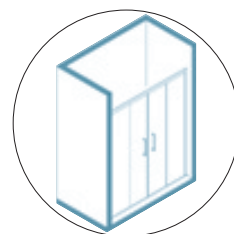

p. 152

5

anni di
GARANZIA



Finitura pannelli

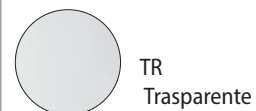

Profili in alluminio





Angolo a quattro ante, apertura ad ante scorrevoli, due fisse con pannelli da 6 mm. e due apribili da 8 mm.

Profili superiori e verticali portanti, assenza di quelli inferiori.

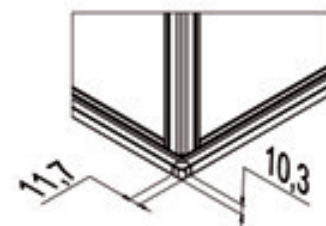
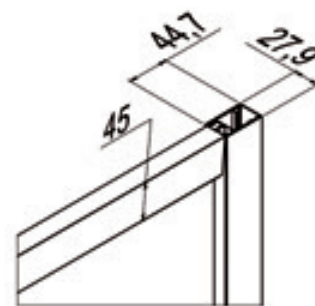
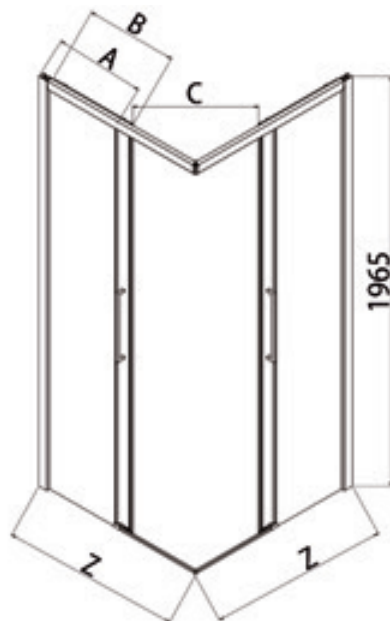
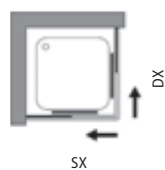
Chiusura rallentata delle ante con sistema Soft Closing.



Le dimensioni sono espresse in mm.

Z [cm]	Cod.	A [cm]	B [cm]	C [cm]	 [dm ³]	 [kg]	 [n°]	Pannelli	L01 [€]	SAR [€]	ULU [€]
67-69	B7916 [1 Lato]	31,2-33,2	34,5	34	118	28	1	TR	535	587	641
								ST	564	616	673
								AS	693	762	832
72-74	B7917 [1 Lato]	33,7-35,7	37	37	128	30	1	TR	546	602	656
								ST	575	634	689
								AS	712	781	851
77-79	B7918 [1 Lato]	36,2-38,2	39,5	41	137	32	1	TR	564	616	672
								ST	587	646	705
								AS	728	799	872
82-84	B7919 [1 Lato]	38,7-40,7	42	44	145	34	1	TR	575	634	688
								ST	602	664	723
								AS	745	819	893
87-89	B7920 [1 Lato]	41,2-43,2	44,5	48	151	37	1	TR	587	646	704
								ST	616	679	740
								AS	762	837	915
97-99	B7921 [1 Lato]	51,2-53,2	44,5	48	168	41	1	TR	615	678	739
								ST	645	712	775
								AS	799	877	954
107-109	B7922 [1 Lato]	61,2-63,2	44,5	48	184	44	1	TR	643	711	772
								ST	675	744	811
								AS	836	918	1002
117-119	B7923 [1 Lato]	71,2-73,2	44,5	48	201	47	1	TR	674	743	808
								ST	710	778	846
								AS	875	961	1046

Tempi di consegna: 1-2 settimane, 2-3 settimane, 3-4 settimane

N.B. I valori della tabella prezzi si riferiscono ad un singolo lato; sommare l'importo dei due codici della misura desiderata per ottenere il prezzo totale di una doccia ad angolo quadrata o rettangolare. Apertura determinata con due lati della stessa misura. La maniglia è sempre in finitura CRO.

Prodotti Speciali	Misure limite	I [€]	II [€]	III [€]
	H max 200 cm / L max 130 cm - min 50 cm	115	135	150

Modulo di richiesta disponibile on-line sul sito: www.samo.it/it/prodotti-speciali - In caso di annullamento dopo l'accettazione, sarà addebitato il costo totale dell'ordine.



Profilo di compensazione optional

Altezza [cm]	Cod.	Estensibilità [cm]	L01 [€]	SAR [€]	ULU [€]
196,5	COM10B	0-3	60	90	90



Trattamento anticalcare di serie compreso nel prezzo



Inquadrare il QR code per collegarsi alla pagina del sito www.samo.it per vedere altre combinazioni di pannelli e vetri

5

anni di
GARANZIA



Finitura pannelli

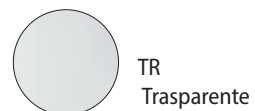

Profili in alluminio



Porta scorrevole a due ante con parete fissa. Apertura laterale ad anta scorrevole, una fissa ed una apribile.

Profili superiori e verticali portanti, assenza di quelli inferiori. **Chiusura rallentata delle ante con sistema Soft Closing.**



SX



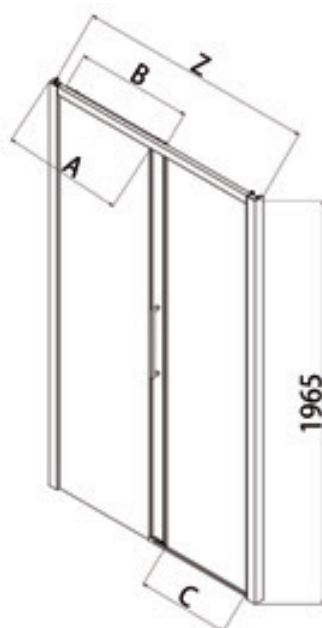

DX

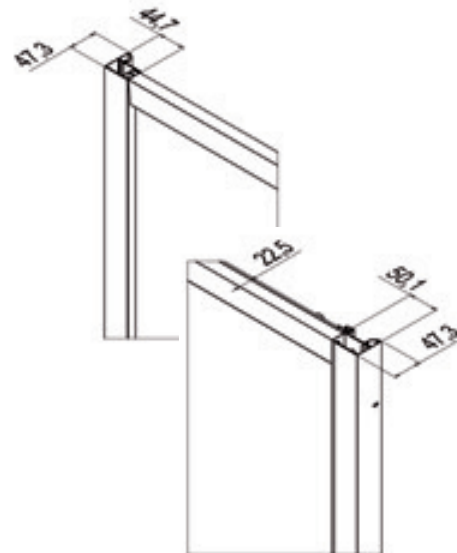

1965



Le dimensioni sono espresse in mm.

Z [cm]	Cod.	A [cm]	B [cm]	C [cm]	 [dm³]	 [kg]	 [n°]	Pannelli	L01 [€]	SAR [€]	ULU [€]
96-101	B7980	45,7-48	46,9	36	121	37	1	TR	722	794	867
								ST	759	836	909
								AS	938	1034	1126
103-108	B7981	49-51,5	50,4	40	130	39	1	TR	744	818	891
								ST	778	858	937
								AS	965	1059	1155
110-115	B7982	52,5-55	53,9	43	137	40	1	TR	762	841	915
								ST	802	879	961
								AS	990	1089	1188
116-121	B7983	55,7-58	56,9	46	145	42	1	TR	785	863	939
								ST	823	905	987
								AS	1019	1119	1219
123-128	B7984	59-61,5	60,4	50	156	44	1	TR	807	889	966
								ST	846	933	1015
								AS	1046	1149	1255
130-135	B7985	62,5-65	63,9	53	158	46	1	TR	829	911	991
								ST	869	958	1043
								AS	1074	1182	1289
136-141	B7986	65,5-68	66,9	56	260	51	2	TR	851	937	1020
								ST	893	982	1072
								AS	1105	1212	1323
145-150	B7987	70-72,5	71,4	61	265	52	2	TR	874	963	1047
								ST	917	1010	1101
								AS	1135	1246	1359
152-157	B7988	73,7-76	74,9	64	273	54	2	TR	900	988	1077
								ST	943	1040	1133
								AS	1165	1280	1399
159-164	B7989	77-79,5	78,4	68	286	57	2	TR	926	1016	1105
								ST	969	1068	1163
								AS	1198	1317	1437
166-171	B7990	80,5-83	81,9	71	294	60	2	TR	951	1045	1137
								ST	994	1098	1193
								AS	1232	1352	1476
173-178	B7991	84-86,5	85,4	75	302	63	2	TR	977	1073	1166
								ST	1021	1128	1231
								AS	1266	1388	1518

Tempi di consegna

1-2 settimane

2-3 settimane

3-4 settimane

La maniglia è sempre in finitura CRO.

Prodotti Speciali	Misure limite	I [€]	II [€]	III [€]
	H max 200 cm / L max 180 cm - min 80 cm	135	185	200

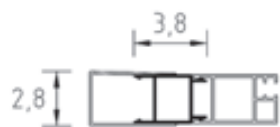
Modulo di richiesta disponibile on-line sul sito: www.samo.it/it/prodotti-speciali - In caso di annullamento dopo l'accettazione, sarà addebitato il costo totale dell'ordine.

Profilo di compensazione optional

Altezza [cm]	Cod.	Estensibilità [cm]	L01 [€]	SAR [€]	ULU [€]
196,5	COM10B	0-3	60	90	90

Parete fissa per abbinamenti (pag. 154-5)

Cod.	B7924	B7925	B7926	B7927	B7928	B7929
Estensibilità	67-69	72-74	77-79	82-84	87-89	97-99

Inquadrare il QR code per collegarsi alla pagina del sito www.samo.it per vedere altre combinazioni di pannelli e vetri

Trattamento anticalcare di serie compreso nel prezzo

5

anni di
GARANZIA



Finitura pannelli

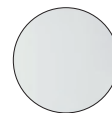

TR
Trasparente



ST
Stampato

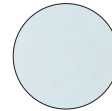

AS
Satinato Acqua

Profili in alluminio



ULU
Brillantato cromo



L01
Bianco

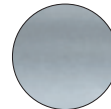

SAR
Satinato Argento

Porta ad un'anta a battente con parete fissa in linea. Apertura verso l'interno e l'esterno.
Profili superiori e verticali portanti, assenza di quelli inferiori.





SX

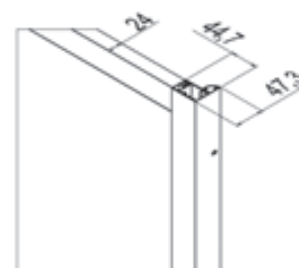
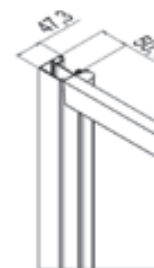
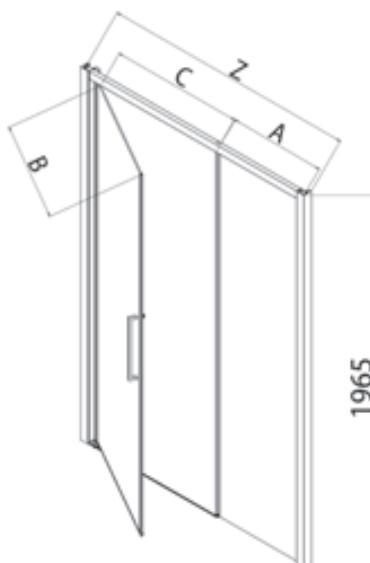

DX



Le dimensioni sono espresse in mm.

Z [cm]	Cod.	A [cm]	B [cm]	C [cm]	 [dm ³]	 [kg]	 [n°]	Pannelli	L01 [€]	SAR [€]	ULU [€]
96-101	B7970	35,1-37,6	53,8	52	121	37	1	TR	861	944	1030
								ST	900	991	1082
								AS	1116	1226	1339
106-111	B7971	33,1-35,6	65,8	64	137	40	1	TR	882	970	1058
								ST	929	1019	1111
								AS	1147	1261	1374
116-121	B7972	35,1-37,6	73,8	72	145	42	2	TR	904	997	1087
								ST	951	1046	1143
								AS	1176	1294	1413
126-131	B7973	45,1-47,6	73,8	72	158	46	2	TR	933	1023	1119
								ST	980	1077	1174
								AS	1211	1332	1451
136-141	B7974	55,1-57,6	73,8	72	260	51	2	TR	955	1051	1148
								ST	1007	1105	1206
								AS	1242	1366	1489
146-151	B7975	65,1-67,6	73,8	72	265	52	2	TR	983	1080	1179
								ST	1035	1137	1239
								AS	1278	1404	1531
156-161	B7976	75,1-77,6	73,8	72	286	57	2	TR	1013	1110	1212
								ST	1064	1167	1274
								AS	1311	1444	1572
166-171	B7977	85,1-87,6	73,8	72	294	60	2	TR	1040	1142	1243
								ST	1090	1199	1306
								AS	1348	1483	1618

Tempi di consegna

1-2 settimane

2-3 settimane

3-4 settimane

La maniglia è sempre in finitura CRO.

Prodotti Speciali	Misure limite	I [€]	II [€]	III [€]
	H max 200 cm / L max 200 cm - min 80 cm	135	155	185

Modulo di richiesta disponibile on-line sul sito: www.samo.it/it/prodotti-speciali - In caso di annullamento dopo l'accettazione, sarà addebitato il costo totale dell'ordine.



Profilo di compensazione optional

Altezza [cm]	Cod.	Estensibilità [cm]	L01 [€]	SAR [€]	ULU [€]
196,5	COM10B	0-3	60	90	90

Parete fissa per abbinamenti (pag. 154-5)

Cod.	B7924	B7925	B7926	B7927	B7928	B7929
Estensibilità	67-69	72-74	77-79	82-84	87-89	97-99



Inquadrare il QR code per collegarsi alla pagina del sito www.samo.it per vedere altre combinazioni di pannelli e vetri



Tattamento anticallcare di serie compreso nel prezzo

5

anni di
GARANZIA

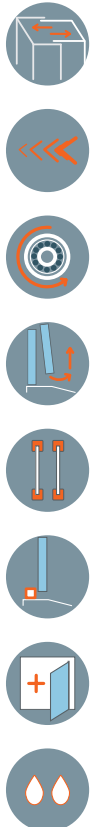

Finitura pannelli

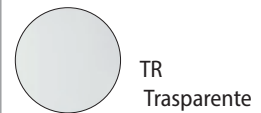

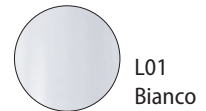

Profili in alluminio

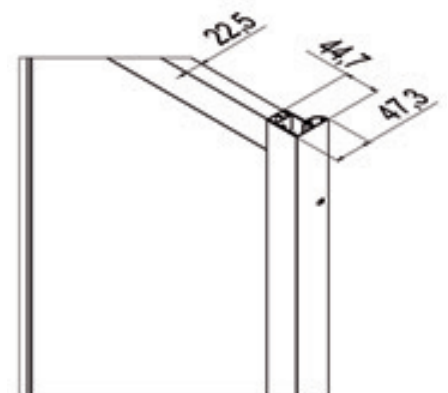
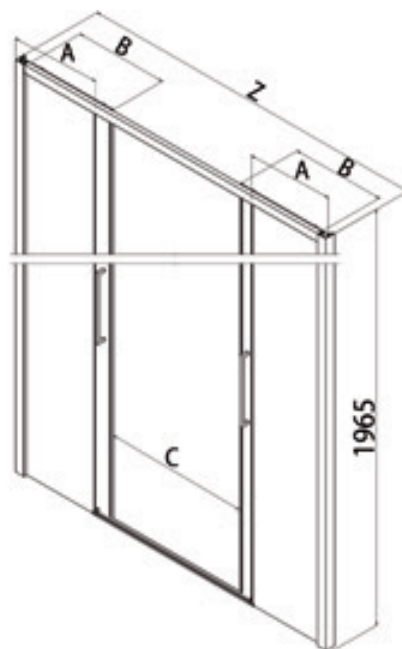

Porta scorrevole a quattro ante, con apertura centrale ad ante scorrevoli, due fisse da e due apribili.
Profili superiori e verticali portanti, assenza di quelli inferiori. **Chiusura rallentata dell'anta con sistema Soft Closing.**



Le dimensioni sono espresse in mm.

Z [cm]	Cod.	A [cm]	B [cm]	C [cm]	 [dm³]	 [kg]	 [n°]	Pannelli	L01 [€]	SAR [€]	ULU [€]
136-141	B7944	33,7 - 36,2	36,5	53	169	53	2	TR	1015	1119	1219
								ST	1068	1171	1278
								AS	1318	1451	1582
146-151	B7945	36,2 - 38,7	39	58	178	57	2	TR	1037	1142	1242
								ST	1088	1198	1304
								AS	1347	1483	1618
156-161	B7946	38,7 - 41,2	41,5	63	181	58	2	TR	1062	1165	1272
								ST	1111	1224	1336
								AS	1375	1515	1651
166-171	B7947	41,2 - 43,7	44	68	192	61	2	TR	1082	1191	1296
								ST	1137	1250	1363
								AS	1406	1548	1685
176-181	B7948	43,7 - 46,2	46,5	73	200	63	2	TR	1105	1218	1328
								ST	1160	1278	1390
								AS	1434	1580	1722
Tempi di consegna					1-2 settimane		2-3 settimane		3-4 settimane		

La maniglia è sempre in finitura CRO.

Prodotti Speciali	Misure limite	I [€]	II [€]	III [€]
	H max 200 cm / L max 200 cm - min 100 cm	200	250	300

Modulo di richiesta disponibile on-line sul sito: www.samo.it/it/prodotti-speciali - In caso di annullamento dopo l'accettazione, sarà addebitato il costo totale dell'ordine.

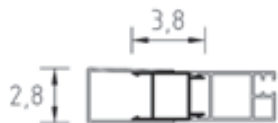

Profilo di compensazione optional

Altezza [cm]	Cod.	Estensibilità [cm]	L01 [€]	SAR [€]	ULU [€]
196,5	COM10B	0-3	60	90	90

Parete fissa per abbinamenti (pag. 154-5)						
Cod.	B7924	B7925	B7926	B7927	B7928	B7929
Estensibilità	67-69	72-74	77-79	82-84	87-89	97-99



Trattamento anticalcare di serie compreso nel prezzo



Inquadrare il QR code per collegarsi alla pagina del sito www.samo.it per vedere altre combinazioni di pannelli e vetri

5

anni di
GARANZIA



Finitura pannelli

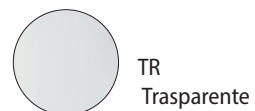



Profili in alluminio

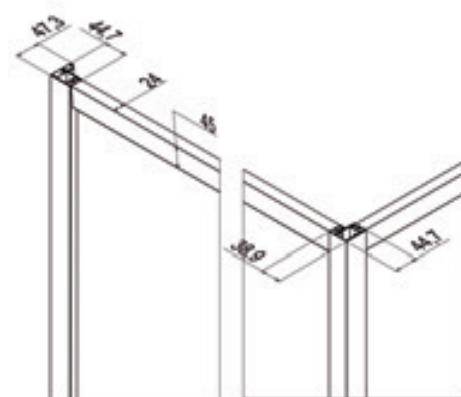
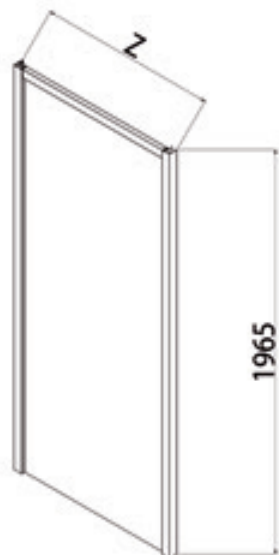

Parete fissa per abbinamenti, è possibile formare cabine doccia a due o tre lati, anche misure rettangolari. Profili superiori e verticali portanti, assenza di quelli inferiori. Non installabile singolarmente o come divisorio.



Le dimensioni sono espresse in mm.

Z [cm]	Cod.	A [cm]	B [cm]	C [cm]	 [dm³]	 [kg]	 [n°]	Pannelli	L01 [€]	SAR [€]	ULU [€]
67-69	B7924	//	//	//	121	24	1	TR	362	397	434
								ST	380	419	454
								AS	469	518	565
72-74	B7925	//	//	//	126	26	1	TR	381	420	456
								ST	398	437	478
								AS	494	543	592
77-79	B7926	//	//	//	130	28	1	TR	399	440	480
								ST	421	461	504
								AS	521	572	622
82-84	B7927	//	//	//	135	30	1	TR	424	464	505
								ST	441	485	530
								AS	545	602	653
87-89	B7928	//	//	//	142	31	1	TR	445	488	533
								ST	466	511	558
								AS	575	635	686
97-99	B7929	//	//	//	149	33	1	TR	467	513	559
								ST	489	538	585
								AS	604	668	723

Tempi di consegna

1-2 settimane

2-3 settimane

3-4 settimane

Prodotti Speciali	Misure limite	I [€]	II [€]	III [€]
	H max 200 cm / L max 120 cm - min 20 cm	70	90	105

Modulo di richiesta disponibile on-line sul sito: www.samo.it/it/prodotti-speciali - In caso di annullamento dopo l'accettazione, sarà addebitato il costo totale dell'ordine.



Profilo di compensazione optional

Altezza [cm]	Cod.	Estensibilità [cm]	L01 [€]	SAR [€]	ULU [€]
196,5	COM10B	0-3	60	90	90



Trattamento anticalcare di serie compreso nel prezzo



Inquadrare il QR code per collegarsi alla pagina del sito www.samo.it per vedere altre combinazioni di pannelli e vetri

Europa





Europa





PLUS DI PRODOTTO



- H 200 cm – V 6/8 mm
- 3 cm di regolazione del fuorisquadra
- Prodotto reversibile
- Ampiezza di gamma completa
- Copertura completa delle misure
- Sgancio anta scorrevole per facilitare la pulizia
- Porte battenti ad apertura interna ed esterna
- Carter di copertura viti a muro
- Interasse maniglia 320 mm
- Anticalcare compreso nel prezzo
- Stampa digitale disponibile su tutti i vetri piani TR





Maniglia interna optional, solo su richiesta:
RIC1418LUC: € 71

Europa



Finitura pannelli

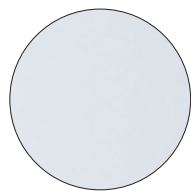

TR
Trasparente

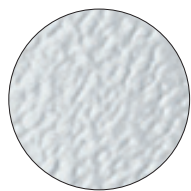

ST
Stampato

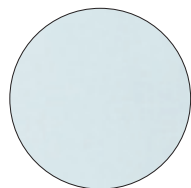

AS
Satinato Acqua

Profili in alluminio

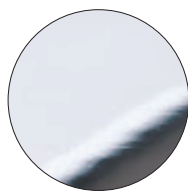

ULU
Brillantato cromo

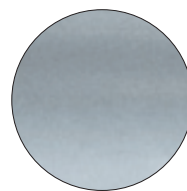

SAR
Satinato argento

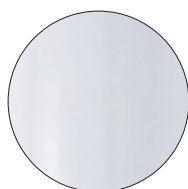

L01
Bianco

Angolo

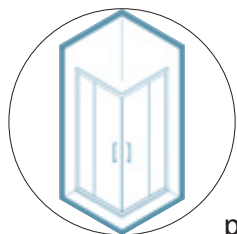

p. 164

Porta

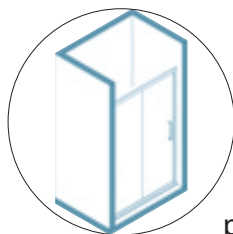

p. 166

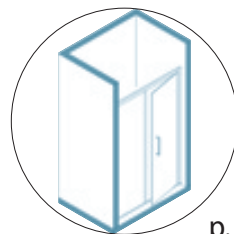

p. 168

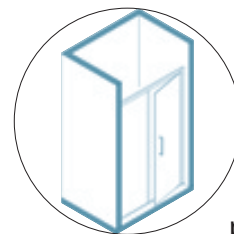

p. 170

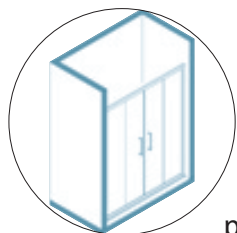

p. 172

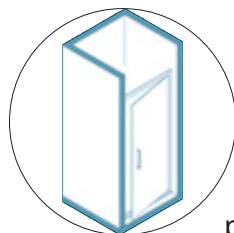

p. 174

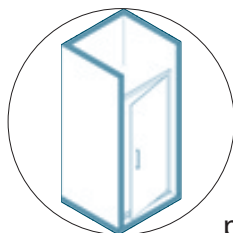

p. 176

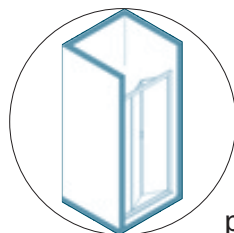

p. 178

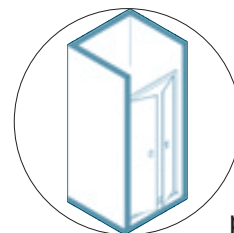

p. 180

Tondo

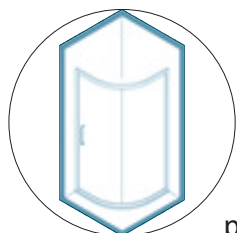

p. 182

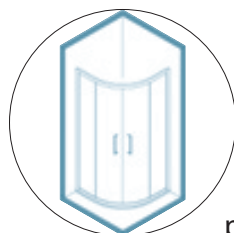

p. 184

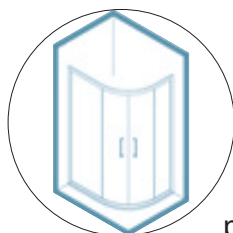

p. 186

Parete fissa

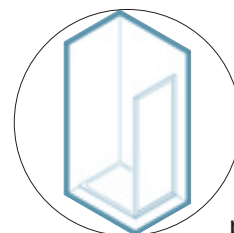

p. 188

5

anni di
GARANZIA

200
cm

6
mm



Finitura pannelli

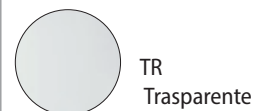

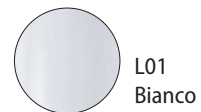

Profili in alluminio

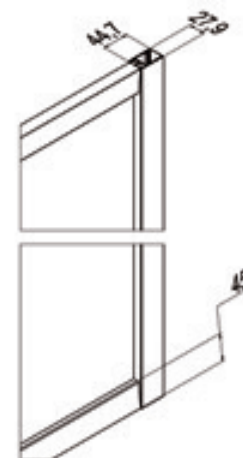
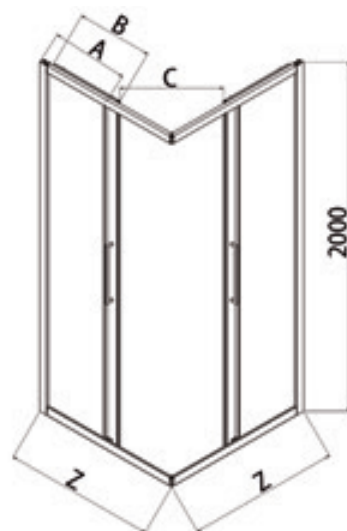
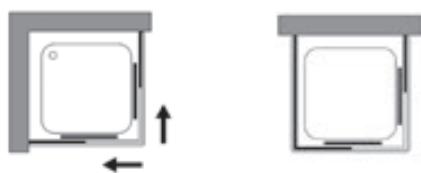

Angolo a quattro ante, apertura ad ante scorrevoli, due fisse e due apribili. Reversibile all'atto dell'installazione.



Le dimensioni sono espresse in mm.

Z [cm]	Cod.	A [cm]	B [cm]	C [cm]	 [dm ³]	 [kg]	 [n°]	Pannelli	L01 [€]	SAR [€]	ULU [€]
67-70	B7816 [1 Lato]	31,2-34,2	33,8	34	118	28	1	TR	494	543	592
								ST	521	572	624
								AS	641	705	770
72-75	B7817 [1 Lato]	33,7-36,7	36,3	37	128	30	1	TR	505	558	604
								ST	533	585	638
								AS	656	723	786
77-80	B7818 [1 Lato]	36,2-39,2	38,8	41	137	33	1	TR	519	571	621
								ST	544	599	653
								AS	672	740	804
82-85	B7819 [1 Lato]	38,7-41,7	41,3	44	145	35	1	TR	530	583	636
								ST	559	614	669
								AS	688	756	826
87-90	B7820 [1 Lato]	41,2-44,2	43,8	48	151	38	1	TR	543	598	650
								ST	572	630	684
								AS	704	776	843
97-100	B7821 [1 Lato]	46,2-49,2	48,8	55	168	41	1	TR	570	627	680
								ST	599	661	717
								AS	739	813	884
107-110	B7822 [1 Lato]	56,2-59,2	48,8	55	184	44	1	TR	597	654	713
								ST	629	690	749
								AS	772	848	927
117-120	B7823 [1 Lato]	66,2-69,2	48,8	55	201	47	1	TR	625	684	745
								ST	659	723	783
								AS	808	888	967

Tempi di consegna

1-2 settimane

2-3 settimane

3-4 settimane

N.B. I valori della tabella prezzi si riferiscono ad un singolo lato: sommare l'importo dei due codici della misura desiderata per ottenere il prezzo totale di una doccia ad angolo quadrata o rettangolare. Apertura determinata con due lati della stessa misura. La maniglia è sempre in finitura CRO.

Prodotti Speciali	Misure limite	I [€]	II [€]	III [€]
	H max 210 cm / L max 130 cm - min 50 cm	115	135	150

Modulo di richiesta disponibile on-line sul sito: www.samo.it/it/prodotti-speciali - In caso di annullamento dopo l'accettazione, sarà addebitato il costo totale dell'ordine.



Profilo di compensazione optional

Altezza [cm]	Cod.	Estensibilità [cm]	L01 [€]	SAR [€]	ULU [€]
200	COM10A	0-3	60	90	90

Parete fissa per abbinamenti (pag. 188-189)

Cod.	B7824	B7825	B7826	B7827	B7828	B7829
Estensibilità	67-70	72-75	77-80	82-85	87-90	97-100



Trattamento anticalcare di serie compreso nel prezzo



Inquadrare il QR code per collegarsi alla pagina del sito www.samo.it per vedere altre combinazioni di pannelli e vetri

5

anni di
GARANZIA

200

cm

6

mm



Finitura pannelli

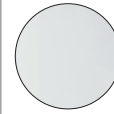

TR
Trasparente

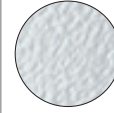

ST
Stampato

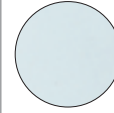

AS
Satinato Acqua

Profili in alluminio



ULU
Brillantato cromo

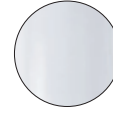

L01
Bianco

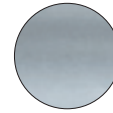

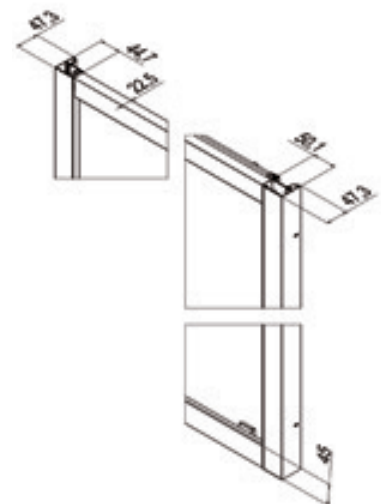
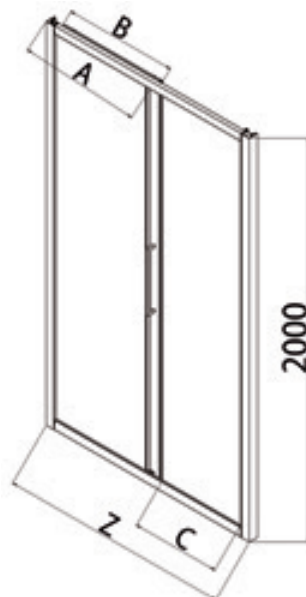
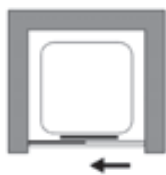

SAR
Satinato Argento

Porta scorrevole a due ante. Apertura laterale ad anta scorrevole, una fissa ed una apribile. Reversibile all'atto dell'installazione.



Le dimensioni sono espresse in mm.

Z [cm]	Cod.	A [cm]	B [cm]	C [cm]	 [dm ³]	 [kg]	 [n°]	Pannelli	L01 [€]	SAR [€]	ULU [€]
96-102	B7880	45,8-48,8	46,8	36	121	37	1	TR	675	744	813
								ST	712	781	851
								AS	877	965	1051
103-109	B7881	49-52	50,4	40	130	39	1	TR	694	765	834
								ST	731	802	875
								AS	900	991	1080
110-116	B7882	52,5-55,5	53,9	43	137	40	1	TR	716	785	858
								ST	750	826	899
								AS	929	1019	1110
116-122	B7883	55,8-58,8	56,9	46	145	42	1	TR	734	808	879
								ST	772	846	928
								AS	951	1046	1142
123-129	B7884	59-62	60,4	50	156	44	1	TR	755	831	902
								ST	793	872	950
								AS	980	1077	1171
130-136	B7885	62,5-65,5	63,9	53	158	46	1	TR	777	853	932
								ST	816	895	976
								AS	1007	1105	1204
136-142	B7886	65,5-68,5	66,9	56	260	51	2	TR	798	877	954
								ST	837	919	1004
								AS	1035	1137	1237
145-151	B7887	70-73	71,4	61	265	52	2	TR	820	900	982
								ST	863	945	1032
								AS	1064	1167	1273
152-158	B7888	73,8-76,8	74,9	64	273	54	2	TR	842	929	1010
								ST	885	971	1062
								AS	1090	1199	1305
159-165	B7889	77-80	78,4	68	286	57	2	TR	868	951	1039
								ST	909	998	1088
								AS	1123	1234	1343
166-172	B7890	80,5-83,5	81,9	71	294	60	2	TR	891	980	1069
								ST	935	1024	1121
								AS	1153	1269	1381
173-179	B7891	84-87	85,4	75	302	63	2	TR	916	1007	1096
								ST	961	1053	1149
								AS	1185	1301	1419

Tempi di consegna

1-2 settimane

2-3 settimane

3-4 settimane

La maniglia è sempre in finitura CRO.

Prodotti Speciali	Misure limite	I [€]	II [€]	III [€]
	H max 210 cm / L max 180 cm - min 80 cm	135	185	200

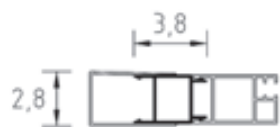
Modulo di richiesta disponibile on-line sul sito: www.samo.it/it/prodotti-speciali - In caso di annullamento dopo l'accettazione, sarà addebitato il costo totale dell'ordine.

Profilo di compensazione optional

Altezza [cm]	Cod.	Estensibilità [cm]	L01 [€]	SAR [€]	ULU [€]
200	COM10A	0-3	60	90	90

Parete fissa per abbinamenti (pag. 188-189)

Cod.	B7824	B7825	B7826	B7827	B7828	B7829
Estensibilità	67-70	72-75	77-80	82-85	87-90	97-100

Inquadrare il QR code per collegarsi alla pagina del sito www.samo.it per vedere altre combinazioni di pannelli e vetri

Trattamento anticalcare di serie compreso nel prezzo

5

anni di
GARANZIA

200
cm

6
mm



Finitura pannelli

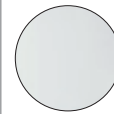

TR
Trasparente

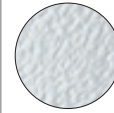

ST
Stampato

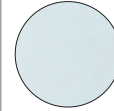

AS
Satinato Acqua

Profili in alluminio



ULU
Brillantato cromo

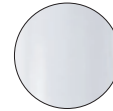

L01
Bianco

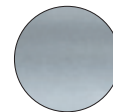

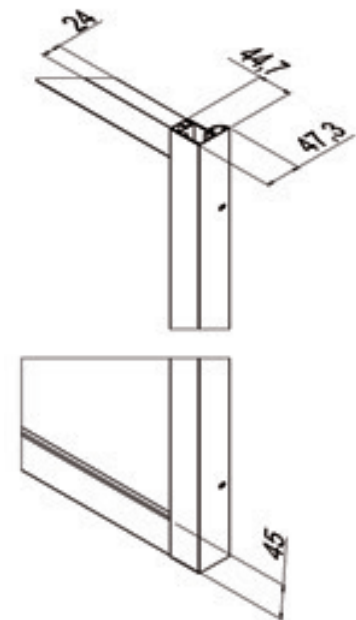
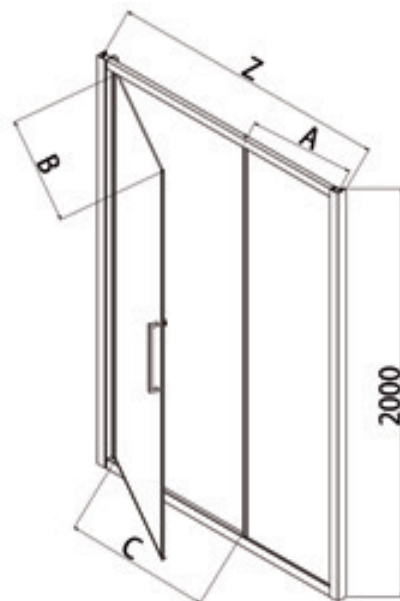

SAR
Satinato Argento

Porta ad un'anta a battente con parete fissa in linea. Apertura verso l'interno e l'esterno.
Profili superiori e verticali portanti, assenza di quelli inferiori.



Le dimensioni sono espresse in mm.

Z [cm]	Cod.	A [cm]	B [cm]	C [cm]	 [dm ³]	 [kg]	 [n°]	Pannelli	L01 [€]	SAR [€]	ULU [€]
96-102	B7870	35,1-38,1	53,8	52	121	37	1	TR	780	861	935
								ST	819	900	982
								AS	1014	1113	1216
106-112	B7871	33,1-36,1	65,8	64	137	40	1	TR	801	882	961
								ST	841	929	1010
								AS	1041	1144	1246
116-122	B7872	35,1-38,1	73,8	72	145	42	2	TR	825	904	987
								ST	867	951	1039
								AS	1072	1175	1282
126-132	B7873	45,1-48,1	73,8	72	158	46	2	TR	845	933	1015
								ST	889	980	1069
								AS	1099	1208	1317
136-142	B7874	55,1-58,1	73,8	72	260	51	2	TR	870	955	1042
								ST	915	1007	1096
								AS	1132	1241	1353
146-152	B7875	65,1-68,1	73,8	72	265	52	2	TR	894	983	1073
								ST	939	1035	1128
								AS	1161	1277	1390
Tempi di consegna						1-2 settimane		2-3 settimane		3-4 settimane	

La maniglia è sempre in finitura CRO.

Prodotti Speciali	Misure limite	I [€]	II [€]	III [€]
	H max 210 cm / L max 200 cm - min 80 cm	135	155	185

Modulo di richiesta disponibile on-line sul sito: www.samo.it/it/prodotti-speciali - In caso di annullamento dopo l'accettazione, sarà addebitato il costo totale dell'ordine.



Profilo di compensazione optional

Altezza [cm]	Cod.	Estensibilità [cm]	L01 [€]	SAR [€]	ULU [€]
200	COM10A	0-3	60	90	90

Parete fissa per abbinamenti (pag. 188-189)						
Cod.	B7824	B7825	B7826	B7827	B7828	B7829
Estensibilità	67-70	72-75	77-80	82-85	87-90	97-100



Inquadrare il QR code per collegarsi alla pagina del sito www.samo.it per vedere altre combinazioni di pannelli e vetri



Trattamento anticalcare di serie compreso nel prezzo

5

anni di
GARANZIA

200

cm

6

mm



Finitura pannelli

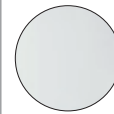

TR
Trasparente



ST
Stampato

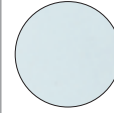

AS
Satinato Acqua

Profili in alluminio



ULU
Brillantato cromo

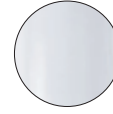

L01
Bianco

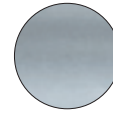

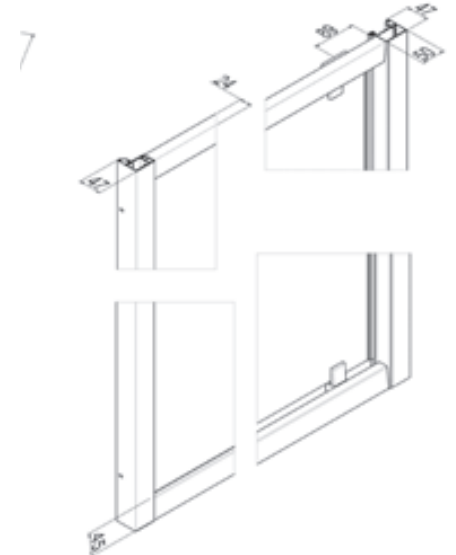
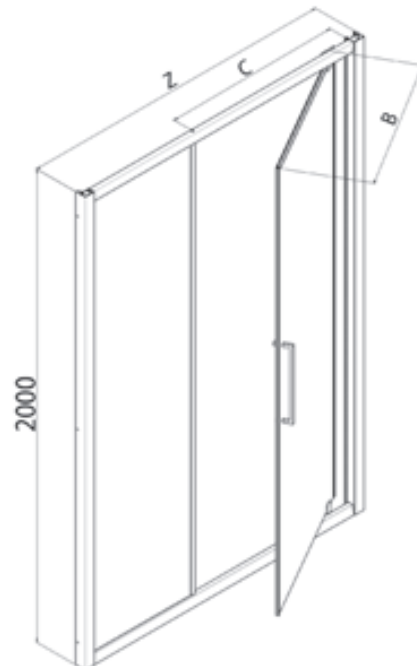

SAR
Satinato Argento

Porta ad un'anta a battente pivotante con parete fissa in linea. Apertura verso l'interno e l'esterno.



Le dimensioni sono espresse in mm.

Z [cm]	Cod.	A [cm]	B [cm]	C [cm]	 [dm³]	 [kg]	 [n°]	Pannelli	L01 [€]	SAR [€]	ULU [€]
96-102	B7864	33,7 - 36,2	36,5	53	121	37	1	TR	780	861	935
								ST	819	900	982
								AS	1014	1113	1216
106-112	B7865	36,2 - 38,7	39	58	137	40	1	TR	801	882	961
								ST	841	929	1010
								AS	1041	1144	1246
116-122	B7866	38,7 - 41,2	41,5	63	145	42	2	TR	825	904	987
								ST	867	951	1039
								AS	1072	1175	1282
126-132	B7867	41,2 - 43,7	44	68	158	46	2	TR	845	933	1015
								ST	889	980	1069
								AS	1099	1208	1317
136-142	B7868	41,2 - 43,7	44	68	192	51	2	TR	870	955	1042
								ST	915	1007	1096
								AS	1132	1241	1353
146-152	B7869	41,2 - 43,7	44	68	192	52	2	TR	894	983	1073
								ST	939	1035	1128
								AS	1161	1277	1390

Tempi di consegna

1-2 settimane

2-3 settimane

3-4 settimane

La maniglia è sempre in finitura CRO.

Prodotti Speciali	Misure limite	I [€]	II [€]	III [€]
	H max 210 cm / L max 200 cm - min 80 cm	135	155	185

Modulo di richiesta disponibile on-line sul sito: www.samo.it/it/prodotti-speciali - In caso di annullamento dopo l'accettazione, sarà addebitato il costo totale dell'ordine.

Profilo di compensazione optional

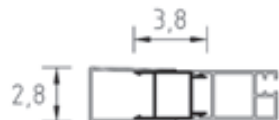

Altezza [cm]	Cod.	Estensibilità [cm]	L01 [€]	SAR [€]	ULU [€]
200	COM10A	0-3	60	90	90

Parete fissa per abbinamenti (pag. 188-189)

Cod.	B7824	B7825	B7826	B7827	B7828	B7829
Estensibilità	67-70	72-75	77-80	82-85	87-90	97-100



Inquadrare il QR code per collegarsi alla pagina del sito www.samo.it per vedere altre combinazioni di pannelli e vetri



Trattamento anticalcare di serie compreso nel prezzo

5

anni di
GARANZIA

200
cm

6
mm



Finitura pannelli

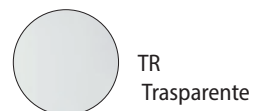

Profili in alluminio



Porta scorrevole a quattro ante, con apertura centrale ad ante scorrevoli, due fisse e due apribili.

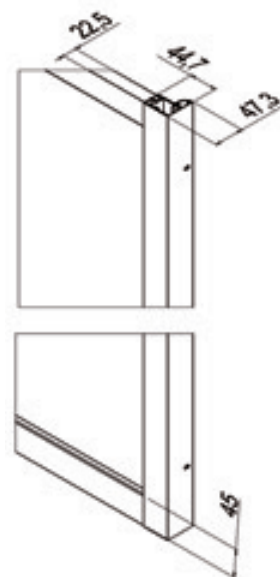
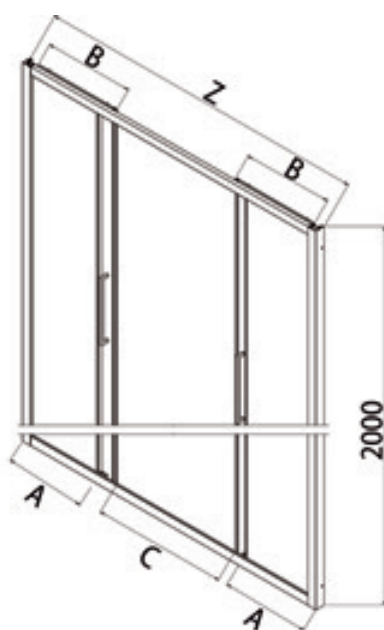

Le dimensioni sono espresse in mm.

Z [cm]	Cod.	A [cm]	B [cm]	C [cm]	 [dm ³]	 [kg]	 [n°]	Pannelli	L01 [€]	SAR [€]	ULU [€]
136-142	B7844	33,7-36,7	36,4	53	169	53	2	TR	924	1015	1105
								ST	970	1069	1164
								AS	1198	1318	1439
146-152	B7845	36,2-39,2	38,9	58	178	57	2	TR	943	1037	1132
								ST	990	1089	1190
								AS	1224	1347	1468
156-162	B7846	38,7-41,7	41,4	63	181	58	2	TR	964	1062	1154
								ST	1013	1113	1216
								AS	1250	1375	1498
166-172	B7847	41,2-44,2	43,9	68	192	61	2	TR	983	1082	1180
								ST	1035	1138	1240
								AS	1278	1406	1531
176-182	B7848	43,7-46,7	46,4	73	200	63	2	TR	1006	1105	1206
								ST	1056	1161	1269
								AS	1304	1434	1564
Tempi di consegna					1-2 settimane		2-3 settimane		3-4 settimane		

La maniglia è sempre in finitura CRO.

Prodotti Speciali	Misure limite	I [€]	II [€]	III [€]
	H max 210 cm / L max 200 cm - min 100 cm	200	250	300

Modulo di richiesta disponibile on-line sul sito: www.samo.it/it/prodotti-speciali - In caso di annullamento dopo l'accettazione, sarà addebitato il costo totale dell'ordine.



Profilo di compensazione optional

Altezza [cm]	Cod.	Estensibilità [cm]	L01 [€]	SAR [€]	ULU [€]
200	COM10A	0-3	60	90	90

Parete fissa per abbinamenti (pag. 188-189)

Cod.	B7824	B7825	B7826	B7827	B7828	B7829
Estensibilità	67-70	72-75	77-80	82-85	87-90	97-100



Inquadrare il QR code per collegarsi alla pagina del sito www.samo.it per vedere altre combinazioni di pannelli e vetri



Trattamento anticalcare di serie compreso nel prezzo

5

anni di
GARANZIA

200

cm

6

mm



Finitura pannelli

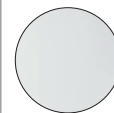

TR
Trasparente

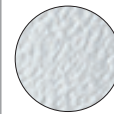

ST
Stampato

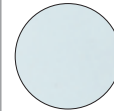

AS
Satinato Acqua

Profili in alluminio



ULU
Brillantato cromo

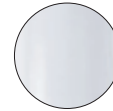

L01
Bianco

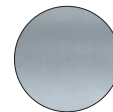

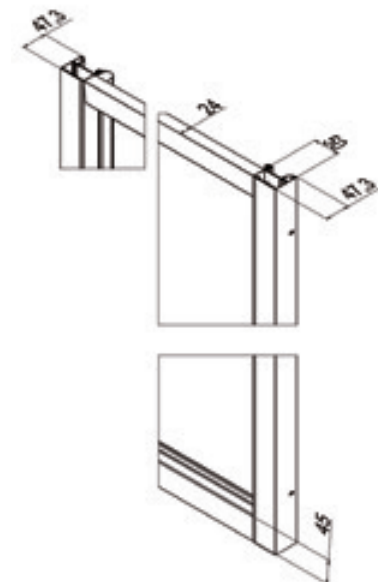
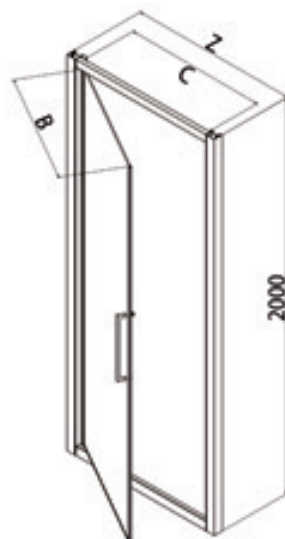

SAR
Satinato Argento

Porta ad un'anta a battente con apertura verso l'interno e l'esterno.



Le dimensioni sono espresse in mm.

Z [cm]	Cod.	A [cm]	B [cm]	C [cm]	 [dm³]	 [kg]	 [n°]	Pannelli	L01 [€]	SAR [€]	ULU [€]
66-72	B7802	//	52,7	52	117	24	1	TR	526	577	632
								ST	551	609	664
								AS	682	749	818
72-78	B7803	//	58,7	58	131	27	1	TR	543	598	653
								ST	572	630	684
								AS	705	776	845
78-84	B7804	//	64,7	64	148	30	1	TR	565	620	675
								ST	592	652	711
								AS	731	802	875
86-92	B7805	//	72,7	72	163	33	1	TR	581	640	698
								ST	613	674	733
								AS	755	831	904
96-102	B7806	//	82,7	82	175	35	1	TR	603	664	726
								ST	635	696	759
								AS	781	862	938

Tempi di consegna

1-2 settimane

2-3 settimane

3-4 settimane

La maniglia è sempre in finitura CRO.

Prodotti Speciali	Misure limite	I [€]	II [€]	III [€]
	H max 210 cm / L max 102 cm - min 50 cm	115	135	150

Modulo di richiesta disponibile on-line sul sito: www.samo.it/it/prodotti-speciali - In caso di annullamento dopo l'accettazione, sarà addebitato il costo totale dell'ordine.



Profilo di compensazione optional

Altezza [cm]	Cod.	Estensibilità [cm]	L01 [€]	SAR [€]	ULU [€]
200	COM10A	0-3	60	90	90

Parete fissa per abbinamenti (pag. 188-189)

Cod.	B7824	B7825	B7826	B7827	B7828	B7829
Estensibilità	67-70	72-75	77-80	82-85	87-90	97-100



Inquadrare il QR code per collegarsi alla pagina del sito www.samo.it per vedere altre combinazioni di pannelli e vetri



Trattamento anticalcare di serie compreso nel prezzo

5

anni di
GARANZIA

200
cm

6
mm



Finitura pannelli

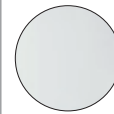

TR
Trasparente

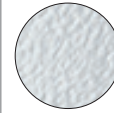

ST
Stampato

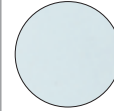

AS
Satinato Acqua

Profili in alluminio



ULU
Brillantato cromo

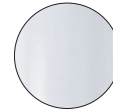

L01
Bianco

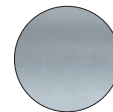

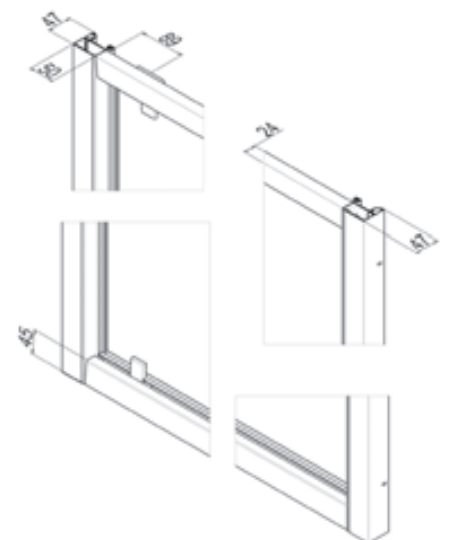
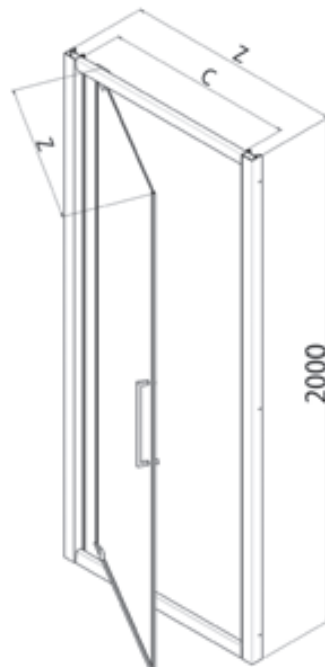

SAR
Satinato Argento

Porta ad un'anta a battente pivot con apertura verso l'interno e l'esterno.



Le dimensioni sono espresse in mm.

Z [cm]	Cod.	A [cm]	B [cm]	C [cm]	 [dm ³]	 [kg]	 [n°]	Pannelli	L01 [€]	SAR [€]	ULU [€]
66-72	B7855	//	45,5	54,5	119	23	1	TR	526	577	632
								ST	551	609	664
								AS	682	749	818
72-78	B7856	//	51,5	60,5	128	27,5	1	TR	543	598	653
								ST	572	630	684
								AS	705	776	845
78-84	B7857	//	57,5	66,5	138	30	1	TR	565	620	675
								ST	592	652	711
								AS	731	802	875
86-92	B7858	//	65,5	74,5	153	32,5	1	TR	581	640	698
								ST	613	674	733
								AS	755	831	904
96-102	B7859	//	75,5	84,5	169	35	1	TR	603	664	726
								ST	635	696	759
								AS	781	862	938

Tempi di consegna

1-2 settimane

2-3 settimane

3-4 settimane

La maniglia è sempre in finitura CRO.

Prodotti Speciali	Misure limite	I [€]	II [€]	III [€]
	H max 210 cm / L max 102 cm - min 50 cm	115	135	150

Modulo di richiesta disponibile on-line sul sito: www.samo.it/it/prodotti-speciali - In caso di annullamento dopo l'accettazione, sarà addebitato il costo totale dell'ordine.



Profilo di compensazione optional

Altezza [cm]	Cod.	Estensibilità [cm]	L01 [€]	SAR [€]	ULU [€]
200	COM10A	0-3	60	90	90

Parete fissa per abbinamenti (pag. 188-189)

Cod.	B7824	B7825	B7826	B7827	B7828	B7829
Estensibilità	67-70	72-75	77-80	82-85	87-90	97-100



Inquadrare il QR code per collegarsi alla pagina del sito www.samo.it per vedere altre combinazioni di pannelli e vetri



Trattamento anticallcare di serie compreso nel prezzo

5

anni di
GARANZIA

200
cm

6
mm



Finitura pannelli

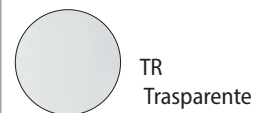

Profili in alluminio

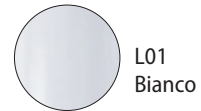

Porta a due ante a soffietto, apertura con ante pieghevoli verso l'interno.

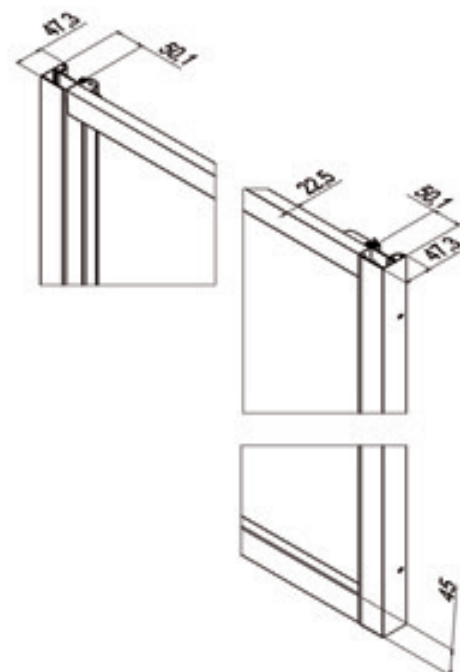
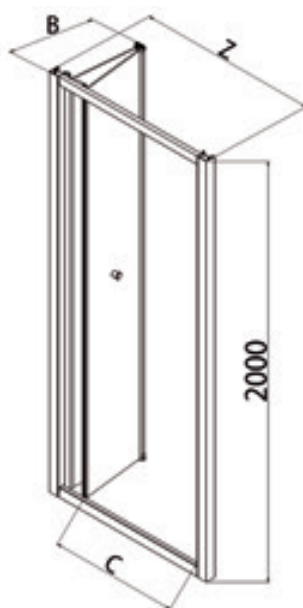

Le dimensioni sono espresse in mm.

Z [cm]	Cod.	A [cm]	B [cm]	C [cm]	 [dm ³]	 [kg]	 [n°]	Pannelli	L01 [€]	SAR [€]	ULU [€]
66-72	B7807	//	30	43	126	26	1	TR	732	804	877
								ST	770	845	924
								AS	949	1043	1139
72-78	B7808	//	33	49	139	30	1	TR	751	829	900
								ST	791	870	948
								AS	975	1074	1170
78-84	B7809	//	36	55	150	32	1	TR	775	850	929
								ST	814	894	974
								AS	1003	1101	1202
86-92	B7810	//	40	63	164	34	1	TR	796	874	951
								ST	835	918	1002
								AS	1030	1134	1236
96-102	B7811	//	45	73	170	36	1	TR	818	898	980
								ST	861	944	1029
								AS	1058	1165	1272
Tempi di consegna					1-2 settimane		2-3 settimane		3-4 settimane		

La maniglia è sempre in finitura CRO.

Prodotti Speciali	Misure limite	I [€]	II [€]	III [€]
	H max 210 cm / L max 120 cm - min 66 cm	145	185	215

Modulo di richiesta disponibile on-line sul sito: www.samo.it/it/prodotti-speciali - In caso di annullamento dopo l'accettazione, sarà addebitato il costo totale dell'ordine.



Profilo di compensazione optional

Altezza [cm]	Cod.	Estensibilità [cm]	L01 [€]	SAR [€]	ULU [€]
200	COM10A	0-3	60	90	90

Parete fissa per abbinamenti (pag. 188-189)

Cod.	B7824	B7825	B7826	B7827	B7828	B7829
Estensibilità	67-70	72-75	77-80	82-85	87-90	97-100



Inquadrare il QR code per collegarsi alla pagina del sito www.samo.it per vedere altre combinazioni di pannelli e vetri



Trattamento anticalcare di serie compreso nel prezzo

5

anni di
GARANZIA

200
cm

6
mm



Finitura pannelli

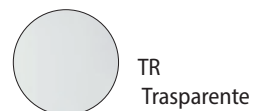

Profili in alluminio

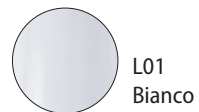

Porta a saloon, apertura ad ante battenti verso l'interno e verso l'esterno.

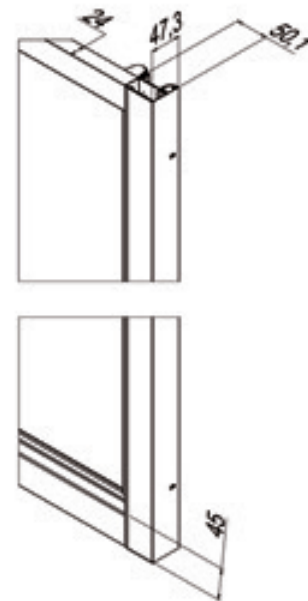
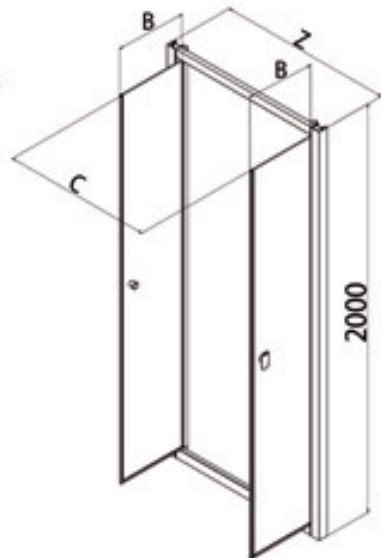

Le dimensioni sono espresse in mm.

Z [cm]	Cod.	A [cm]	B [cm]	C [cm]	 [dm ³]	 [kg]	 [n°]	Pannelli	L01 [€]	SAR [€]	ULU [€]
66-72	B7830	//	22,7	52	119	25	1	TR	554	610	666
								ST	581	641	696
								AS	721	792	864
72-78	B7831	//	25,7	58	141	28	1	TR	572	630	684
								ST	601	664	722
								AS	743	818	889
78-84	B7832	//	28,7	64	141	32	1	TR	591	648	710
								ST	621	683	744
								AS	766	842	918
86-92	B7833	//	32,7	72	155	34	1	TR	610	670	731
								ST	640	704	767
								AS	791	870	947
96-102	B7834	//	37,7	82	170	36	1	TR	630	690	751
								ST	662	728	792
								AS	816	896	976
106-112	B7835	//	42,7	92	186	38	1	TR	648	715	777
								ST	682	749	818
								AS	841	928	1009
116-122	B7836	//	47,7	102	211	40	1	TR	670	738	801
								ST	702	775	842
								AS	869	953	1040
Tempi di consegna					1-2 settimane		2-3 settimane		3-4 settimane		

La maniglia è sempre in finitura CRO.

Prodotti Speciali	Misure limite	I [€]	II [€]	III [€]
	H max 210 cm / L max 122 cm - min 50 cm	115	155	185

Modulo di richiesta disponibile on-line sul sito: www.samo.it/it/prodotti-speciali - In caso di annullamento dopo l'accettazione, sarà addebitato il costo totale dell'ordine.



Profilo di compensazione optional

Altezza [cm]	Cod.	Estensibilità [cm]	L01 [€]	SAR [€]	ULU [€]
200	COM10A	0-3	60	90	90

Parete fissa per abbinamenti (pag. 188-189)

Cod.	B7824	B7825	B7826	B7827	B7828	B7829
Estensibilità	67-70	72-75	77-80	82-85	87-90	97-100



Inquadrare il QR code per collegarsi alla pagina del sito www.samo.it per vedere altre combinazioni di pannelli e vetri



Trattamento anticalcare di serie compreso nel prezzo

5

anni di
GARANZIA

200
cm

6
mm



Finitura pannelli

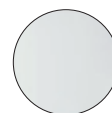

TR
Trasparente

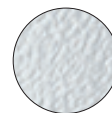

ST
Stampato

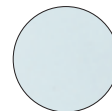

AS
Satinato Acqua

Profili in alluminio



ULU
Brillantato cromo

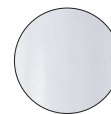

L01
Bianco

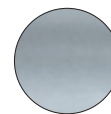

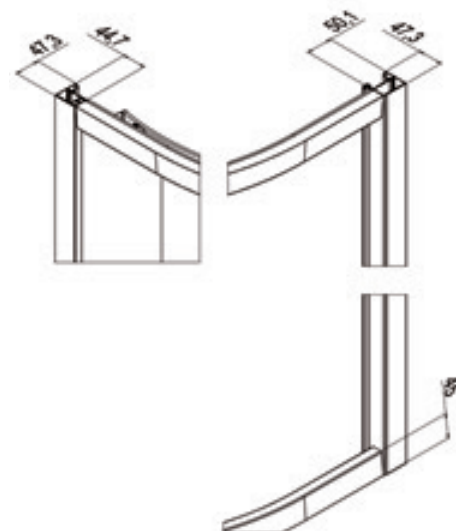
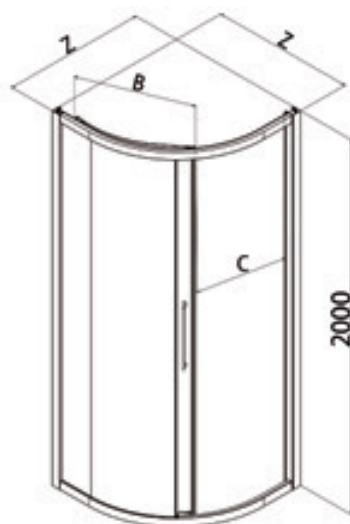

SAR
Satinato Argento

Tondo a due ante, apertura laterale ad anta scorrevole, una fissa ed una apribile. Reversibile all'atto dell'installazione.



Le dimensioni sono espresse in mm.

Z [cm]	Cod.	A [cm]	B [cm]	C [cm]	 [dm ³]	 [kg]	 [n°]	Pannelli	L01 [€]	SAR [€]	ULU [€]
76,5-79,5	B7863	//	57,3	45	369	50	2	TR	1063	1167	1274
								ST	1116	1226	1339
								AS	1379	1518	1653
86,5-89,5	B7862	//	67	54	450	54	2	TR	1121	1230	1343
								ST	1175	1293	1412
								AS	1453	1598	1745
Tempi di consegna					1-2 settimane		2-3 settimane		3-4 settimane		

Adatto a piatti doccia a raggio NON costante (80x80 - 90x90 cm.) - Raggio curvatura 55 cm.
La maniglia è sempre in finitura CRO.

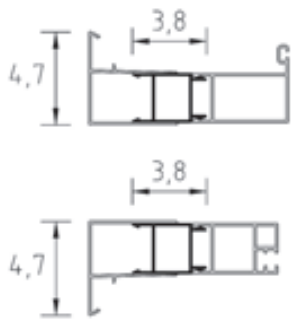

Profilo di compensazione optional

Altezza [cm]	Cod.	Estensibilità [cm]	L01 [€]	SAR [€]	ULU [€]
200	COM10A	0-3	60	90	90



Inquadrare il QR code per collegarsi alla pagina del sito
www.samo.it per vedere altre combinazioni di pannelli e vetri



Trattamento anticalcare di serie compreso nel prezzo

5

anni di
GARANZIA

200
cm

6
mm



Finitura pannelli

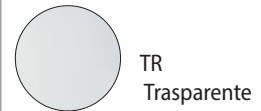



Profili in alluminio

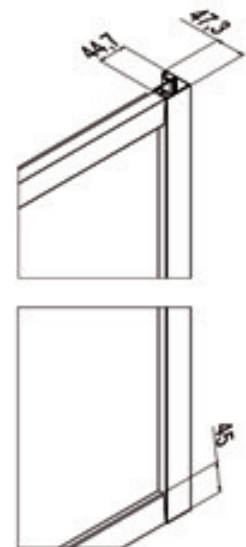
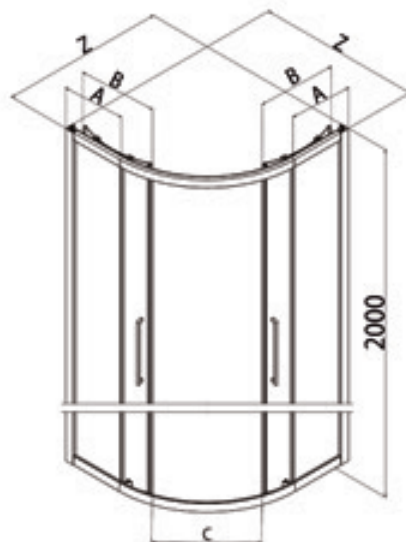

Tondo scorrevole a quattro ante, due fisse laterali e due apribili frontali.



Le dimensioni sono espresse in mm.

Z [cm]	Cod.	A [cm]	B [cm]	C [cm]	 [dm ³]	 [kg]	 [n°]	Pannelli	L01 [€]	SAR [€]	ULU [€]
76,5-79,5	B7853	22,5-25,5	41	39	249	50	2	TR	1035	1139	1241
								ST	1085	1195	1304
								AS	1345	1479	1613
86,5-89,5	B7852	32,5-35,5	41	47	287	56	2	TR	1085	1196	1304
								ST	1143	1256	1370
								AS	1412	1554	1693
96,5-99,5	B7854	42,5-45,5	41	47	346	63	2	TR	1175	1294	1412
								ST	1236	1358	1483
								AS	1528	1682	1831
Tempi di consegna						1-2 settimane	2-3 settimane	3-4 settimane			

Adatto a piatti doccia a raggio NON costante (80x80 - 90x90 - 100x100 cm.) - Raggio curvatura 55 cm.
La maniglia è sempre in finitura CRO.

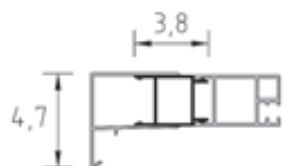

Profilo di compensazione optional

Altezza [cm]	Cod.	Estensibilità [cm]	L01 [€]	SAR [€]	ULU [€]
200	COM10A	0-3	60	90	90

Prodotti Speciali	Misure limite	I [€]	II [€]	III [€]
	H max 200 cm / Larghezza min e max richiedere fattibilità	275	//	350

Modulo di richiesta disponibile on-line sul sito: www.samo.it/it/prodotti-speciali - In caso di annullamento dopo l'accettazione, sarà addebitato il costo totale dell'ordine.



Inquadrare il QR code per collegarsi alla pagina del sito www.samo.it per vedere altre combinazioni di pannelli e vetri



Trattamento anticalcare di serie compreso nel prezzo

5

anni di
GARANZIA

200
cm

6
mm



Finitura pannelli

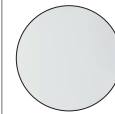

TR
Trasparente



ST
Stampato

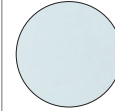

AS
Satinato Acqua

Profili in alluminio



ULU
Brillantato cromo

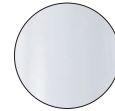

L01
Bianco

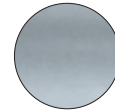

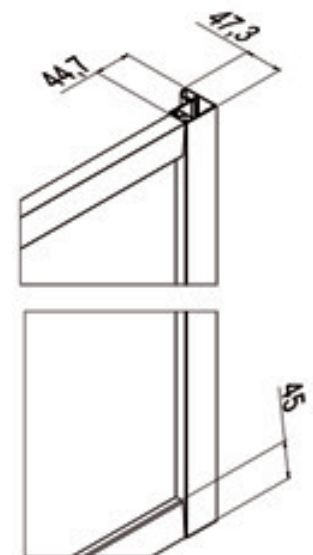
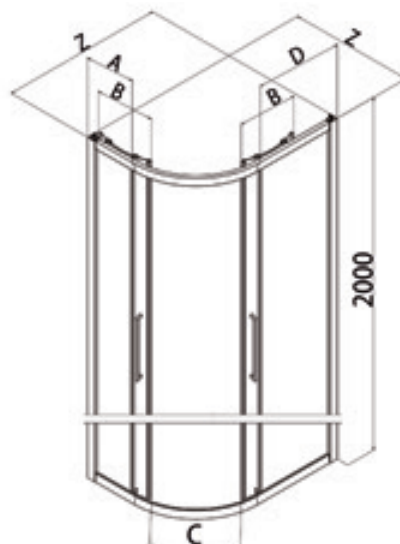

SAR
Satinato Argento

Rettagonolare stondato scorrevole a quattro ante, due fisse laterali e due apribili frontali.



Le dimensioni sono espresse in mm.

Z [cm]	Cod.	A [cm]	B [cm]	C [cm]	D [cm]	 [dm³]	 [kg]	 [n°]	Pannelli	L01 [€]	SAR [€]	ULU [€]
66,5-69,5/86,5-89,5	B7893	25,7-28,7	30,9	38	45,7-48,7	254	52	2	TR	1088	1196	1304
									ST	1143	1256	1371
									AS	1414	1555	1695
76,5-79,5/96,5-99,5	B7895	35,7-38,7	30,9	38	55,7-58,7	308	58	2	TR	1148	1263	1375
									ST	1204	1326	1447
									AS	1489	1637	1788
Tempi di consegna						1-2 settimane		2-3 settimane		3-4 settimane		

Adatto a piatti doccia a raggio NON costante (70x90 - 80x100 cm.) - Raggio curvatura 38 cm.
La maniglia è sempre in finitura CRO.

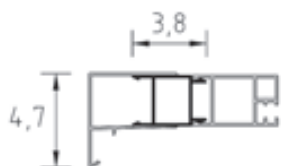

Profilo di compensazione optional

Altezza [cm]	Cod.	Estensibilità [cm]	L01 [€]	SAR [€]	ULU [€]
200	COM10A	0-3	60	90	90

Prodotti Speciali	Misure limite	I [€]	II [€]	III [€]
	H max 200 cm / Larghezza min e max richiedere fattibilità	275	//	350

Modulo di richiesta disponibile on-line sul sito: www.samo.it/it/prodotti-speciali - In caso di annullamento dopo l'accettazione, sarà addebitato il costo totale dell'ordine.



Inquadrare il QR code per collegarsi alla pagina del sito www.samo.it per vedere altre combinazioni di pannelli e vetri



Trattamento anticalcare di serie compreso nel prezzo

5

anni di
GARANZIA

200
cm

6
mm



Finitura pannelli

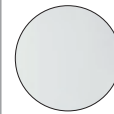

TR
Trasparente



ST
Stampato

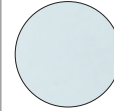

AS
Satinato Acqua

Profili in alluminio



ULU
Brillantato cromo

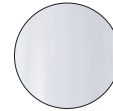

L01
Bianco

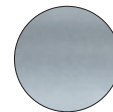

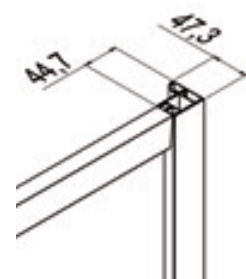
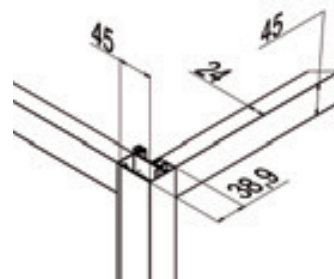
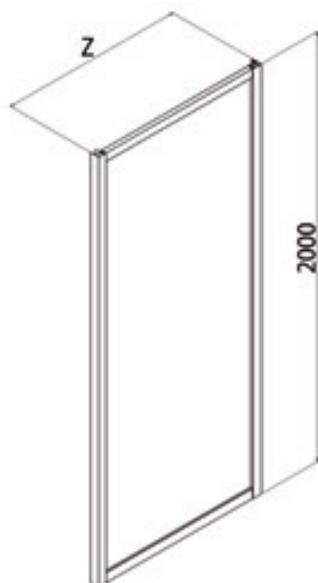

SAR
Satinato Argento

Parete fissa per abbinamenti, è possibile formare cabine doccia a 2 o 3 lati, anche misure rettangolari.
Non installabile singolarmente o come divisorio.



Le dimensioni sono espresse in mm.

Z [cm]	Cod.	A [cm]	B [cm]	H [cm]	 [dm ³]	 [kg]	 [n°]	Pannelli	L01 [€]	SAR [€]	ULU [€]
67-70	B7824	//	//	200	121	24	1	TR	329	364	394
								ST	346	381	418
								AS	429	470	513
72-75	B7825	//	//	200	126	26	1	TR	348	382	419
								ST	365	399	436
								AS	451	495	540
77-80	B7826	//	//	200	130	28	1	TR	366	401	437
								ST	383	424	459
								AS	474	522	570
82-85	B7827	//	//	200	135	30	1	TR	386	425	461
								ST	402	445	484
								AS	497	546	599
87-90	B7828	//	//	200	142	31	1	TR	403	446	485
								ST	426	467	510
								AS	524	576	632
97-100	B7829	//	//	200	149	33	1	TR	427	468	511
								ST	448	490	537
								AS	550	606	666

Tempi di consegna

1-2 settimane

2-3 settimane

3-4 settimane

Prodotti Speciali

Misure limite

I [€]

II [€]

III [€]

H max 210 cm / L max 120 cm - min 20 cm

70

90

105

Modulo di richiesta disponibile on-line sul sito: www.samo.it/it/prodotti-speciali - In caso di annullamento dopo l'accettazione, sarà addebitato il costo totale dell'ordine.

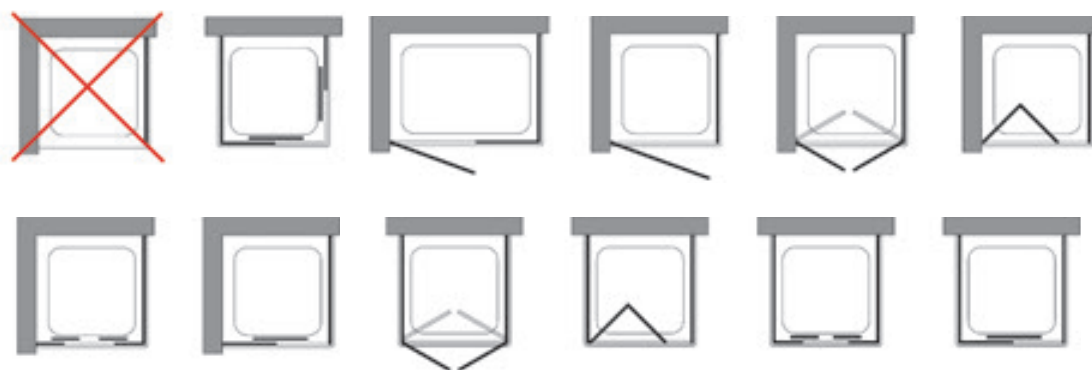

Profilo di compensazione optional

Altezza [cm]	Cod.	Estensibilità [cm]	L01 [€]	SAR [€]	ULU [€]
200	COM10A	0-3	60	90	90



Inquadrare il QR code per collegarsi alla pagina del sito www.samo.it per vedere altre combinazioni di pannelli e vetri



Trattamento anticallcare di serie compreso nel prezzo

StoneFit



Finitura piatti

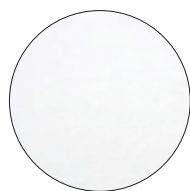

R01
Bianco



R10
Artic



R06
Nero



R17
Grigio



R08
Sabbia



R19
Tortora

StoneFit

La proposta di piatti in StoneFit cresce ulteriormente offrendo una proposizione cromatica con l'inserimento di colorazioni che ben si adattano alla voglia di continuo cambiamento stilistico. Di grande impatto la nuova texture "effetto goffrato" che dona ai piatti doccia un'esperienza sensoriale indimenticabile e al tempo stesso garantisce stabilità e sicurezza con il suo effetto antiscivolo.

StoneFit diventa sinonimo di "su misura". Il nome stesso del prodotto è l'unione del termine Stone per indicare le caratteristiche di resistenza e di sensazione tattile, e del suffisso Fit (letteralmente, "su misura") per indicare la possibilità di poter contare su un prodotto sartoriale grazie alla scelta della misura al centimetro. Il taglio del piatto può essere eseguito sia in larghezza che in lunghezza: la natura di questo materiale permette di tagliarlo e plasmarlo come si desidera.

La possibilità di richiedere forme specifiche, inoltre, garantisce la soluzione ottimale in tutte le circostanze: ostacoli e colonne sono ora facilmente superabili grazie alla possibilità di sagomare i piatti tramite l'uso di specifici utensili (tipo "flex").

5

anni di
GARANZIA



Finitura piatti

-  R01
Bianco
-  R06
Nero
-  R08
Sabbia
-  R10
Artic
-  R17
Grigio
-  R19
Tortora

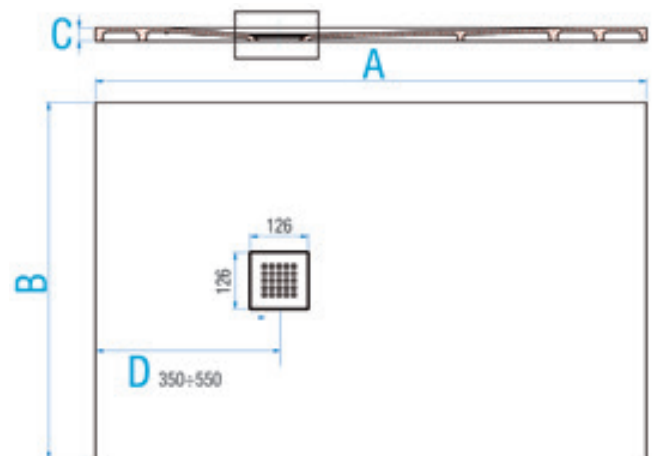
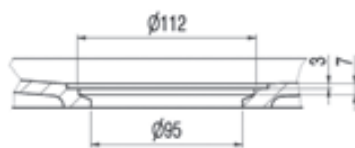
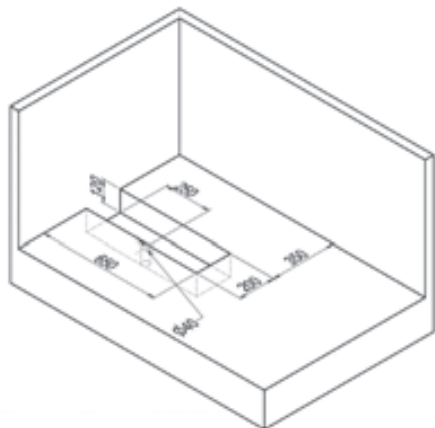

STONEFIT incassato in appoggio a pavimento

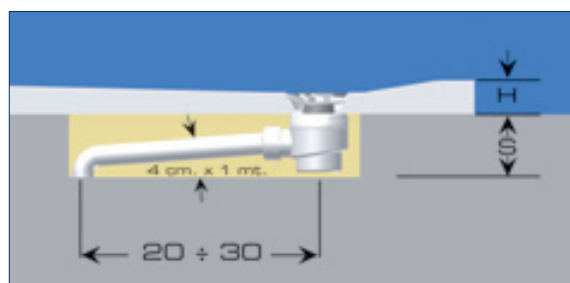

H= 3 cm.

S= 9 cm.

 Miscela sabbia/cemento

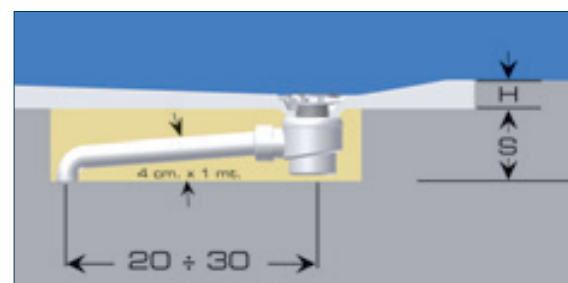

STONEFIT incassato a filo pavimento



H= 3 cm.

S= 9 cm.

 Massetto/pavimento

B [cm]	A [cm]	Cod.	C [cm]	D [cm]	 [kg]	 [n°]	R01 [€]	R06 [€]	R08 [€]	R10 [€]	R17 [€]	R19 [€]
90	90	D3690	3	35	24	1	812	812	812	812	812	812
90	100	D3692	3	35	27	1	812	812	812	812	812	812
90	120	D3693	3	40	32	1	864	864	864	864	864	864
90	140	D3694	3	40	38	1	977	977	977	977	977	977
90	160	D3695	3	45	43	1	1072	1072	1072	1072	1072	1072
90	180	D3696	3	50	49	1	1146	1146	1146	1146	1146	1146

Tempi di consegna

1-2 settimane



2-3 settimane

3-4 settimane

Superficie: R = effetto Goffrato. Incasso a muro massimo 2 cm. Tubo di scarico universale in dotazione.

Piletta di scarico KS3000 in dotazione.

Copripiletta in tinta con il piatto in dotazione (RIC2346R01-R06-R08-R10-R17-R19).

B [cm]	A [cm]	Cod.	C [cm]	 [kg]	 [n°]	[€]
90	90 ÷ 100	DS3690	3	24 ÷ 27	1	812
90	101 ÷ 120		3	27 ÷ 32	1	864
90	121 ÷ 140		3	32 ÷ 38	1	977
90	141 ÷ 160		3	38 ÷ 43	1	1072
90	161 ÷ 180		3	43 ÷ 49	1	1146

Prodotti Speciali	Misure limite del lato B	I [€]	II [€]	III [€]
	L max 89 cm - min 85 cm	120	//	//

Modulo di richiesta disponibile on-line sul sito: www.samo.it/it/prodotti-speciali - In caso di annullamento dopo l'accettazione, sarà addebitato il costo totale dell'ordine.



Taglio ad hoc in lunghezza, compreso nel prezzo.



Taglio ad hoc in larghezza, prezzo vedi tabella. L'ufficio Clienti potrà confermare la fattibilità dell'articolo. "In caso di taglio a misura si consiglia l'incasso a filo pavimento"



Inquadrare il QR code per collegarsi alla pagina del sito www.samo.it per vedere altre varianti colore



Installazione: 1/2 persone

5

anni di
GARANZIA



Finitura piatti

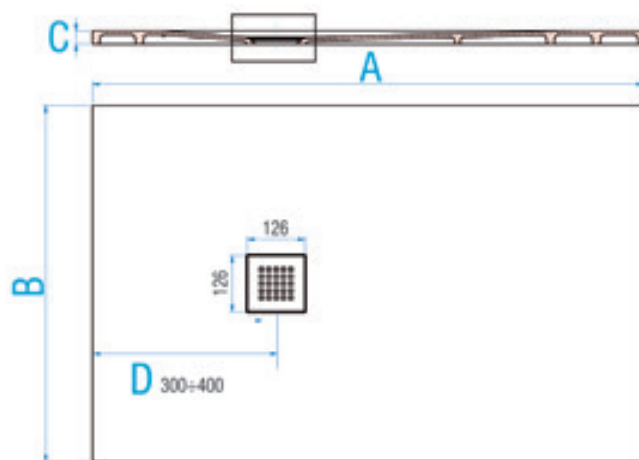
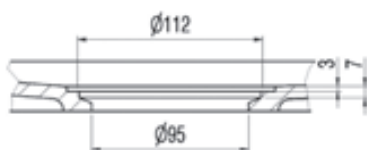
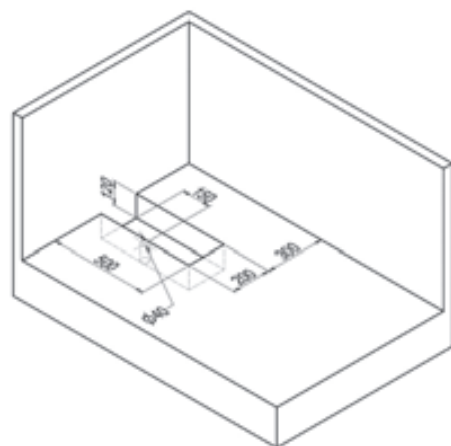

STONEFIT incassato in appoggio a pavimento

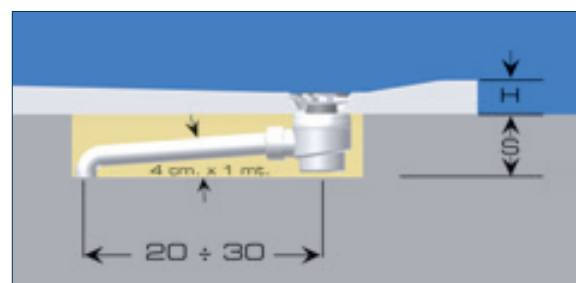

H= 3 cm.

S= 9 cm.



Miscela sabbia/cemento

STONEFIT incassato a filo pavimento

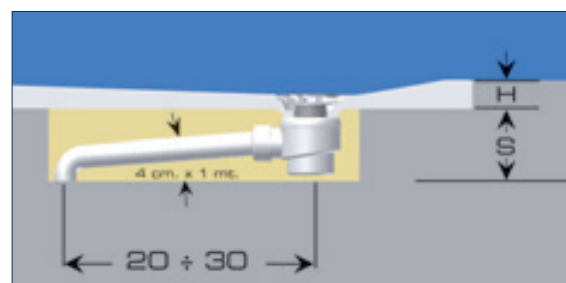



H= 3 cm.

S= 9 cm.



Massetto/pavimento

B [cm]	A [cm]	Cod.	C [cm]	D [cm]	 [kg]	 [n°]	R01 [€]	R06 [€]	R08 [€]	R10 [€]	R17 [€]	R19 [€]
80	80	D3680	3	30	19	1	757	757	757	757	757	757
80	100	D3682	3	30	24	1	757	757	757	757	757	757
80	120	D3683	3	30	29	1	817	817	817	817	817	817
80	140	D3684	3	40	34	1	893	893	893	893	893	893
80	160	D3685	3	40	38	1	989	989	989	989	989	989
80	180	D3686	3	40	43	1	1098	1098	1098	1098	1098	1098

Tempi di consegna

1-2 settimane



2-3 settimane

3-4 settimane

Superficie: R = effetto Goffrato. Incasso a muro massimo 2 cm. Tubo di scarico universale in dotazione.

Piletta di scarico KS3000 in dotazione.

Copripiletta in tinta con il piatto in dotazione (RIC2346R01-R06-R08-R10-R17-R19).

B [cm]	A [cm]	Cod.	C [cm]	 [kg]	 [n°]	[€]
80	80 ÷ 100	DS3680	3	19 ÷ 24	1	757
80	101 ÷ 120		3	24 ÷ 29	1	817
80	121 ÷ 140		3	29 ÷ 34	1	893
80	141 ÷ 160		3	34 ÷ 39	1	989
80	161 ÷ 180		3	39 ÷ 43	1	1098

Prodotti Speciali	Misure limite del lato B	I [€]	II [€]	III [€]
	L max 79 cm - min 75 cm	120	//	//

Modulo di richiesta disponibile on-line sul sito: www.samo.it/it/prodotti-speciali - In caso di annullamento dopo l'accettazione, sarà addebitato il costo totale dell'ordine.



Taglio ad hoc in lunghezza, compreso nel prezzo.



Taglio ad hoc in larghezza, prezzo vedi tabella. L'ufficio Clienti potrà confermare la fattibilità dell'articolo. "In caso di taglio a misura si consiglia l'incasso a filo pavimento"



Inquadrare il QR code per collegarsi alla pagina del sito www.samo.it per vedere altre varianti colore



Installazione: 1/2 persone

5

anni di
GARANZIA



Finitura piatti

-  R01
Bianco
-  R06
Nero
-  R08
Sabbia
-  R10
Artic
-  R17
Grigio
-  R19
Tortora

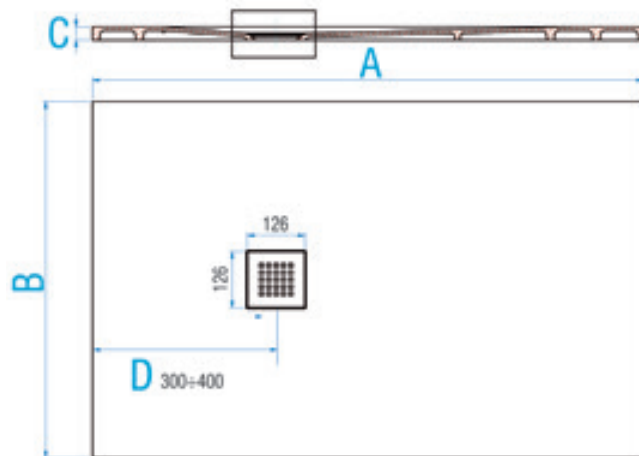
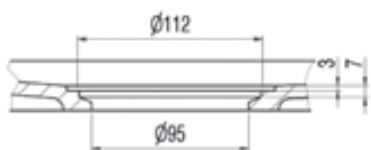
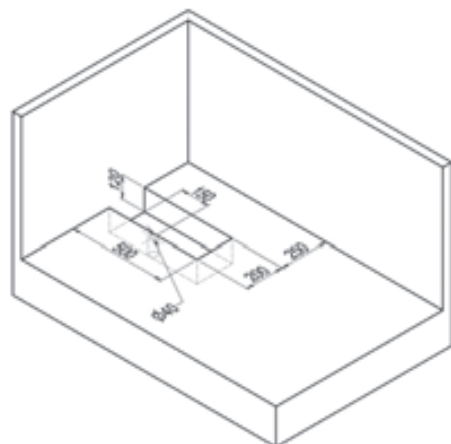

STONEFIT incassato in appoggio a pavimento

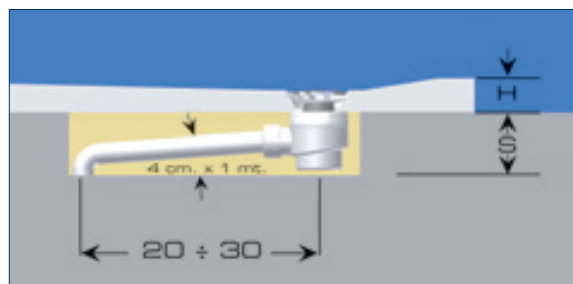

H= 3 cm.

S= 9 cm.

 Miscela sabbia/cemento

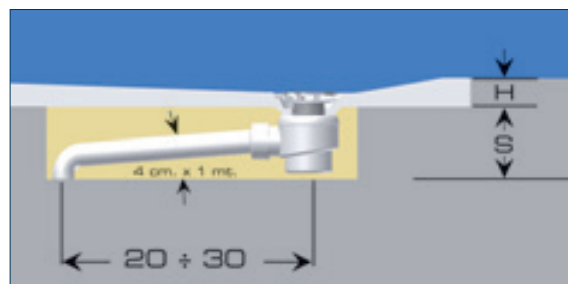

STONEFIT incassato a filo pavimento



H= 3 cm.

S= 9 cm.

 Massetto/pavimento

B [cm]	A [cm]	Cod.	C [cm]	D [cm]	 [kg]	 [n°]	R01 [€]	R06 [€]	R08 [€]	R10 [€]	R17 [€]	R19 [€]
70	90	D3671	3	30	17	1	741	741	741	741	741	741
70	100	D3672	3	30	21	1	741	741	741	741	741	741
70	120	D3673	3	30	25	1	794	794	794	794	794	794
70	140	D3674	3	40	29	1	870	870	870	870	870	870
70	160	D3675	3	40	34	1	970	970	970	970	970	970
70	180	D3676	3	40	38	1	1069	1069	1069	1069	1069	1069

Tempi di consegna

1-2 settimane



2-3 settimane

3-4 settimane

Superficie: R = effetto Goffrato. Incasso a muro massimo 2 cm. Tubo di scarico universale in dotazione.

Piletta di scarico KS3000 in dotazione.

Copripiletta in tinta con il piatto in dotazione (RIC2346R01-R06-R08-R10-R17-R19).

B [cm]	A [cm]	Cod.	C [cm]	 [kg]	 [n°]	[€]
70	80 ÷ 100	DS3670	3	17 ÷ 21	1	741
70	101 ÷ 120		3	21 ÷ 25	1	794
70	121 ÷ 140		3	25 ÷ 29	1	870
70	141 ÷ 160		3	29 ÷ 34	1	970
70	161 ÷ 180		3	34 ÷ 38	1	1069

Prodotti Speciali	Misure limite del lato B	I [€]	II [€]	III [€]
	L max 69 cm - min 65 cm	120	//	//

Modulo di richiesta disponibile on-line sul sito: www.samo.it/it/prodotti-speciali - In caso di annullamento dopo l'accettazione, sarà addebitato il costo totale dell'ordine.



Taglio ad hoc in lunghezza, compreso nel prezzo.



Taglio ad hoc in larghezza, prezzo vedi tabella. L'ufficio Clienti potrà confermare la fattibilità dell'articolo. "In caso di taglio a misura si consiglia l'incasso a filo pavimento"



StoneFit



Inquadrare il QR code per collegarsi alla pagina del sito www.samo.it per vedere altre varianti colore



Installazione: 1/2 persone



Finitura rivestimenti

-  R01
Bianco
-  R06
Nero
-  R08
Sabbia
-  R10
Artic
-  R17
Grigio
-  R19
Tortora



Rivestimenti in StoneFit

La linea di Rivestimenti samo completa la gamma dei piatti doccia StoneFit offrendo una soluzione estetica che dona continuità e grande impatto visivo.

I Rivestimenti StoneFit sono ideali per nuove installazioni e per le ristrutturazioni. Trovano infatti la loro massima espressione nelle situazioni nelle quali sia richiesto di trasformare la zona della vasca da bagno in una nuova e attuale area doccia priva di barriere architettoniche. La vostra sala da bagno acquisterà così una prospettiva moderna e al passo con i tempi.

I Rivestimenti StoneFit sono disponibili nella stessa texture e nelle sei gradazioni cromatiche dei piatti doccia StoneFit: crea l'effetto che più ti piace grazie alla possibilità di mixare i diversi e accattivanti colori o scegli una soluzione di continuità abbinando al piatto doccia StoneFit un Rivestimento della stessa tonalità!



BxA [cm]	Cod.	C [cm]	 [kg]	 [n°]	[€]
70x100	RV3670100	1,2	15	1	440
70x140	RV3670140	1,2	21	1	440
70x180	RV3670180	1,2	27	1	440
Tempi di consegna		1-2 settimane	2-3 settimane	3-4 settimane	

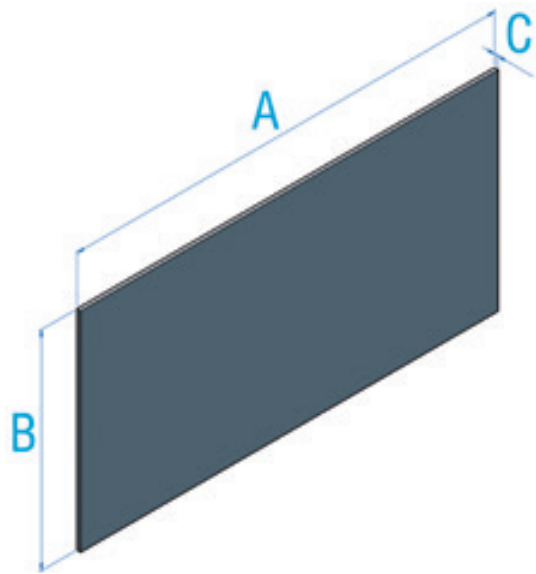

Possibili combinazioni

I pannelli possono essere tagliati su misura (con "flex") per formare molteplici misure e combinazioni. Di seguito solo alcuni esempi.

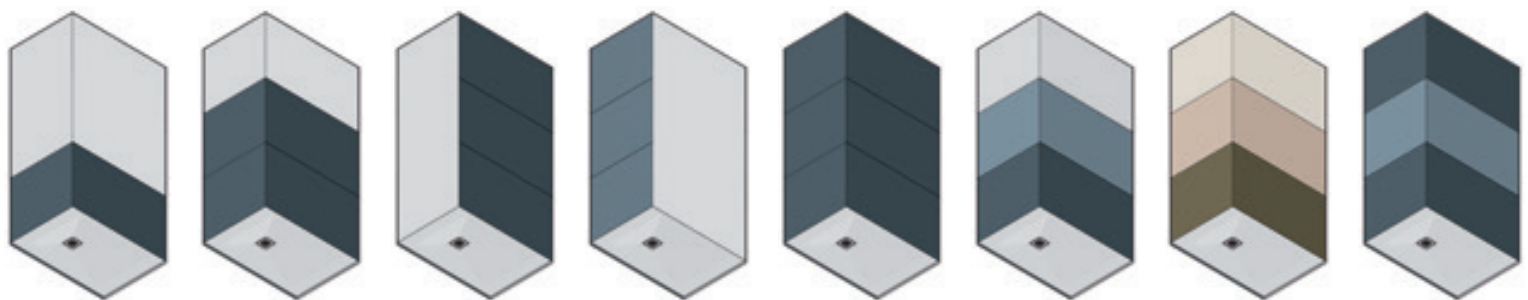

StoneFit



Inquadrare il QR code per collegarsi alla pagina del sito www.samo.it per vedere altre varianti colore



Installazione: 1/2 persone

Stone



Finitura piatti



R01
Bianco



R06
Nero

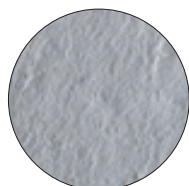

R17
Grigio

Stone

La proposta di samo per i piatti in Stone nasce dalla volontà di mettere a disposizione dell'acquirente nel minor tempo possibile un piatto doccia in "mineralmarmo" con le stesse caratteristiche strutturali dello StoneFit. Di grande impatto la texture che dona ai piatti stessi una sensazione sensoriale indimenticabile e al tempo stesso garantisce stabilità e sicurezza grazie all'effetto antiscivolo. Misure stabilite, colori: bianco, grigio e nero.

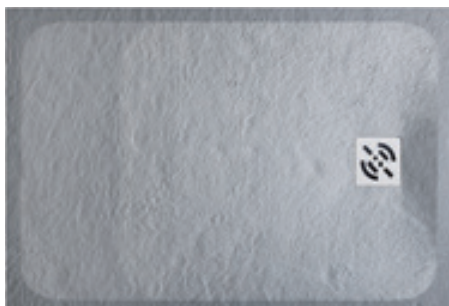
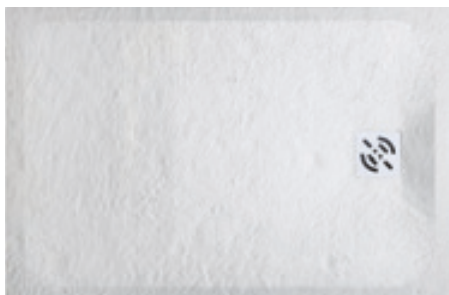

Stone

5

anni di
GARANZIA



Finitura piatti



R01
Bianco



R06
Nero



R17
Grigio

Di grande impatto la nuova texture che dona ai piatti stessi una sensazione sensoriale indimenticabile e al tempo stesso garantisce stabilità e sicurezza grazie all'effetto antiscivolo.

Misure stabili per poter rendere il prodotto disponibile immediatamente, colori bianco, nero e grigio.

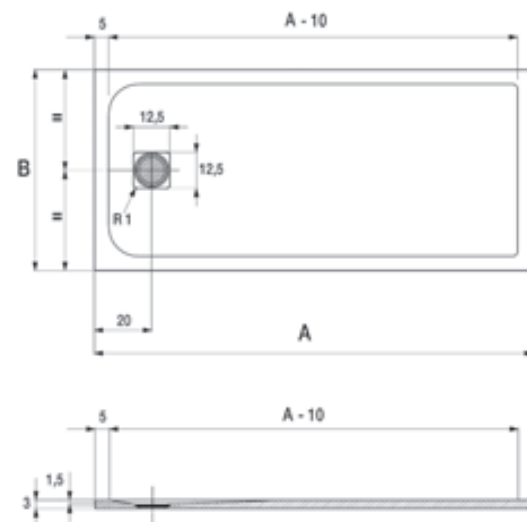
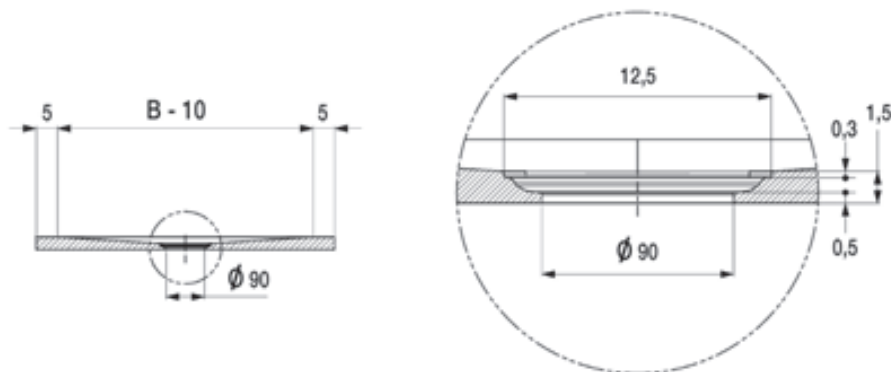

STONE incassato in appoggio a pavimento

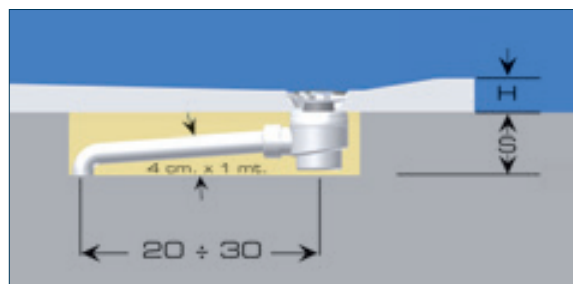

H= 3 cm.
S= 12 cm.



Miscela sabbia/cemento

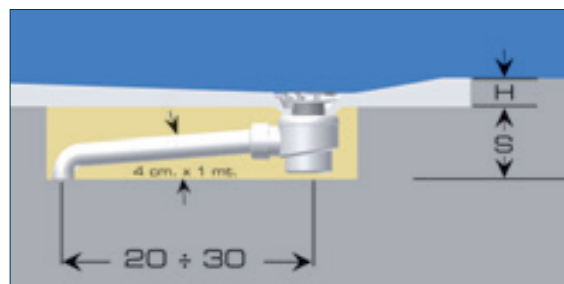

STONE incassato a filo pavimento



H= 3 cm.
S= 12 cm.



Massetto/pavimento

B [cm]	A [cm]	Cod.	C [cm]	 [kg]	 [n°]	R01 [€]	R06 [€]	R17 [€]
70	90	D3071	3	16	1	454	454	454
70	100	D3072	3	31	1	520	520	520
70	120	D3073	3	39	1	612	612	612
70	140	D3074	3	46	1	650	650	650
80	80	D3080	3	25	1	435	435	435
80	100	D3081	3	44	1	548	548	548
80	120	D3082	3	52	1	638	638	638
80	140	D3083	3	61	1	691	691	691
90	90	D3090	3	36	1	481	481	481
90	100	D3091	3	46	1	572	572	572
90	120	D3092	3	56	1	678	678	678
90	140	D3093	3	66	1	731	731	731

Tempi di consegna

1-2 settimane

2-3 settimane

3-4 settimane

Incasto a muro massimo 2 cm. Tubo di scarico universale in dotazione. **Piletta di scarico optional: (KS3000).**

Griglia copripiletta inox satinato in dotazione (RIC1778SAT).

Griglia copripiletta in tinta con il piatto optional (RIC2358R01-R06-R17).



Stone



Inquadrare il QR code per collegarsi alla pagina del sito www.samo.it per vedere altre varianti colore



Installazione: 1/2 persone



Cee Art SP



Cee Art SP



B0720ULURF



B0786L96TR



B0776_B0787L95ST



B0746L91TR

PLUS DI PRODOTTO



- H 196,5 cm – V 6 mm
- 2 cm di regolazione del fuorisquadra
- Serie completa di porte scorrevoli
- Sgancio anta scorrevole per facilitare la pulizia
- Soft closing optional, solo su richiesta
- Carter copertura viti a muro
- Interasse maniglia 160 mm
- Anticalcare optional, solo su richiesta
- Stampa digitale disponibile su tutti i vetri piani TR



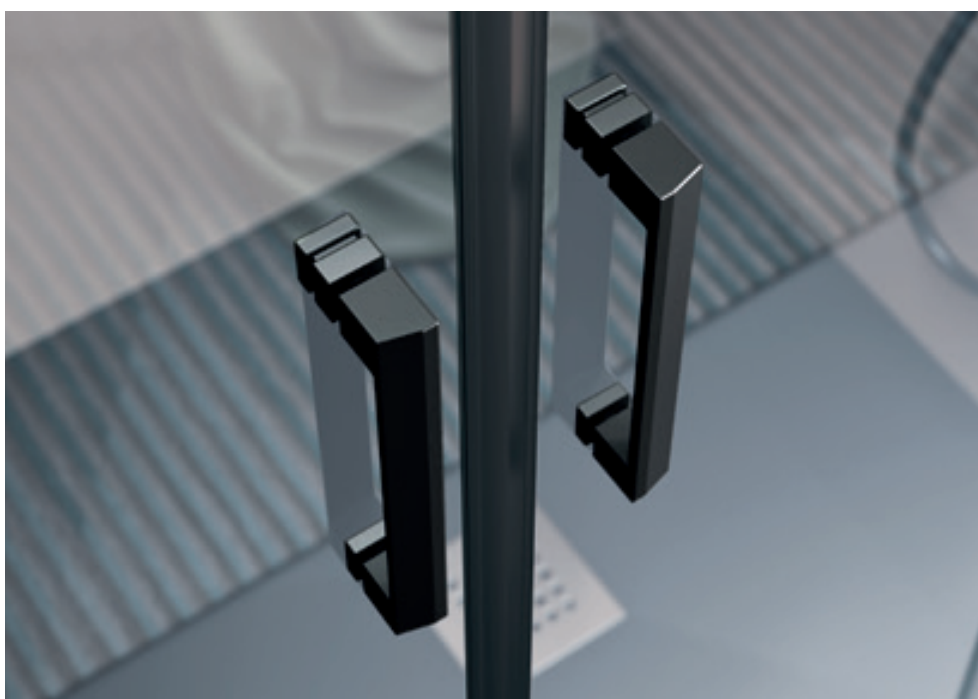
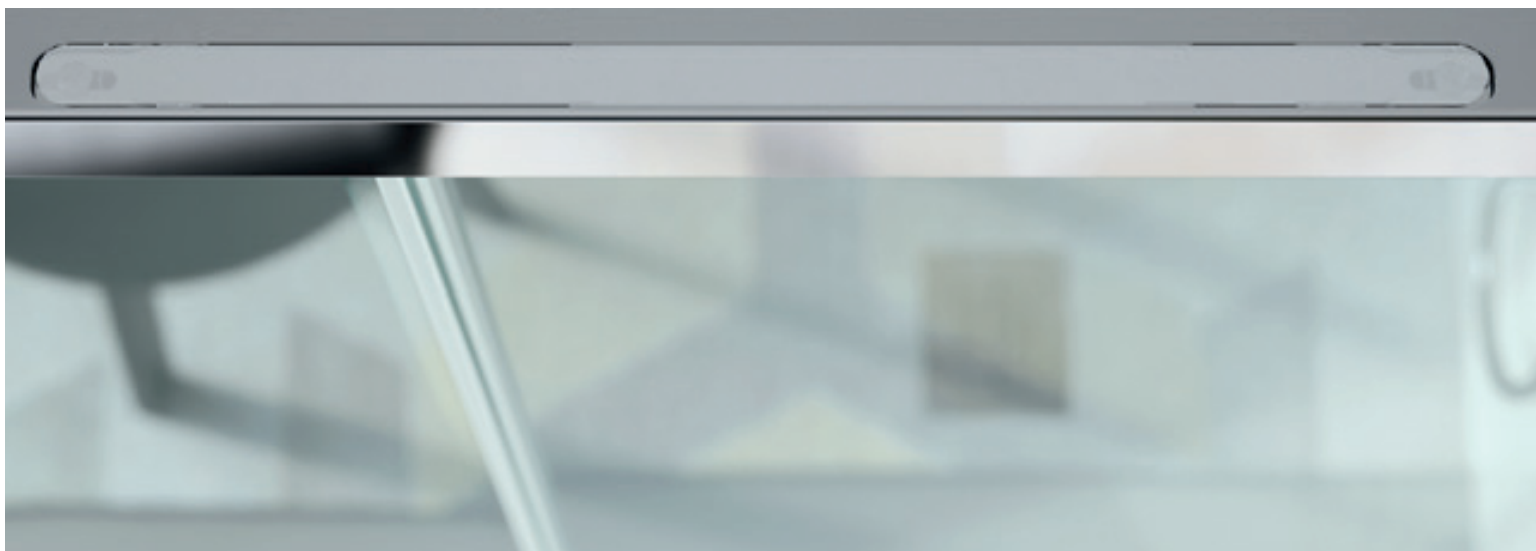

Cee Art SP



Finitura pannelli

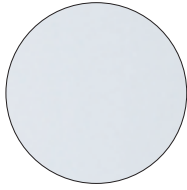

TR
Trasparente

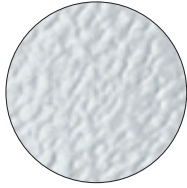

ST
Stampato

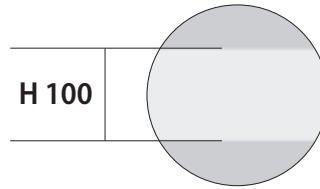

RF
Trasparente con fascia satinata H. 100 cm.

Profili in alluminio



ULU
Brillantato cromo

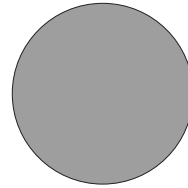

L95
Grigio opaco

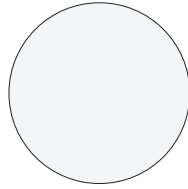

L91
Bianco opaco

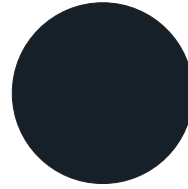

L96
Nero opaco

Angolo

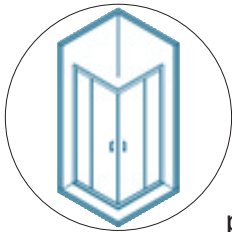

p. 212

Porta

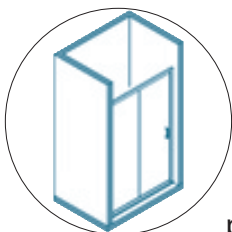

p. 214

Parete fissa

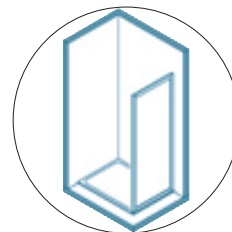

p. 220

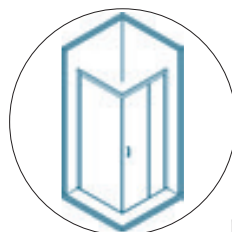

p. 216

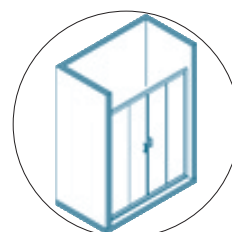

p. 218

Cee Art SP



196,5
cm

6
mm



Finitura pannelli

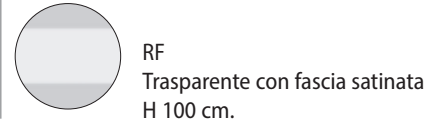
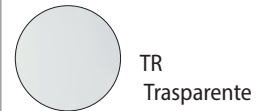

Profili in alluminio

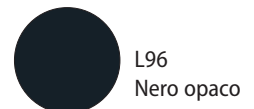
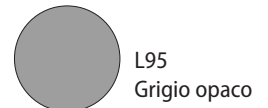

Angolo a quattro ante, apertura ad ante scorrevoli, due fisse e due apribili.

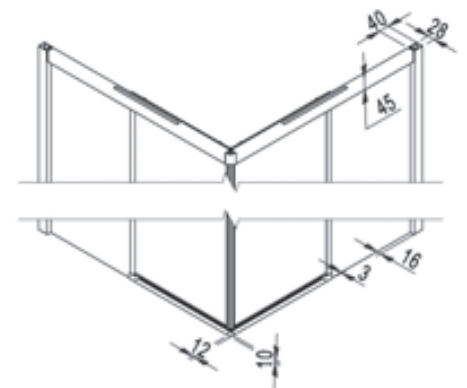
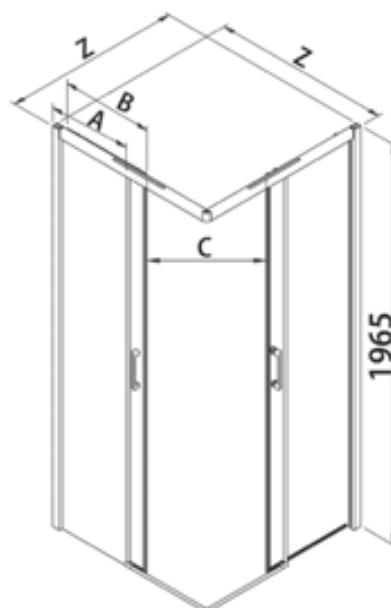
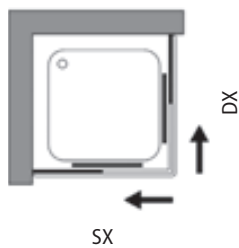

Le dimensioni sono espresse in mm.

Z [cm]	Cod.	A [cm]	B [cm]	C [cm]	 [dm³]	 [kg]	 [n°]	Pannelli	ULU [€]	L91-L95-L96 [€]
67,5-69,5	B0716 [1 Lato]	30,8-32,8	35,6	34	112	26	1	TR	562	562
								ST	591	591
								RF	647	647
70,5-72,5	B0714 [1 Lato]	33,3-35,3	35,6	36	115	28	1	TR	570	570
								ST	599	599
								RF	656	656
72,5-74,5	B0717 [1 Lato]	35,8-37,8	35,6	36	122	28	1	TR	575	575
								ST	604	604
								RF	662	662
75,5-77,5	B0715 [1 Lato]	35,8-37,8	38,1	40	124	30	1	TR	582	582
								ST	612	612
								RF	670	670
77,5-79,5	B0718 [1 Lato]	35,8-37,8	40,6	41	130	30	1	TR	587	587
								ST	617	617
								RF	676	676
80,5-82,5	B0719 [1 Lato]	38,3-40,3	40,6	44	136	30	1	TR	604	604
								ST	635	635
								RF	695	695
87,5-89,5	B0720 [1 Lato]	40,8-42,8	45,6	48	144	35	1	TR	619	619
								ST	650	650
								RF	712	712
90,5-92,5	B0721 [1 Lato]	43,3-45,3	45,6	48	152	35	1	TR	634	634
								ST	666	666
								RF	730	730
97,5-99,5	B0722 [1 Lato]	50,8-52,8	45,6	48	160	38	1	TR	646	646
								ST	679	679
								RF	743	743
117,5-119,5	B0723 [1 Lato]	70,8-72,8	45,6	48	175	41	1	TR	710	710
								ST	746	746
								RF	817	817

Tempi di consegna

1-2 settimane

2-3 settimane

3-4 settimane

N.B. I valori della tabella prezzi si riferiscono ad un singolo lato: sommare l'importo dei due codici con la misura desiderata per ottenere il prezzo totale di un box doccia ad angolo quadrato o rettangolare.

Nota: apertura determinata con due lati della stessa misura.

Per il trattamento StarClean considerare un aumento di una settimana dei tempi di consegna.

Prodotti Speciali	Misure limite	I [€]	II [€]	III [€]
	H max 200 cm / L max 130 cm - min 50 cm	100	125	140

Modulo di richiesta disponibile on-line sul sito: www.samo.it/it/prodotti-speciali - In caso di annullamento dopo l'accettazione, sarà addebitato il costo totale dell'ordine.



Profilo di compensazione optional

Altezza [cm]	Cod.	Estensibilità [cm]	ULU [€]	L96 [€]	L91-L95 [€]
196,5	COM10B	0-3	90	90	90

Soft Closing		[€]
RIC2849	Sistema di chiusura Soft Closing, optional solo su richiesta	53

Parete fissa per abbinamenti (pag. 220-1)

Cod.	B0724	B0725	B0760	B0726	B0727	B0728	B0761	B0729
Estensibilità	67,5-69,5	70,5-72,5	75,5-77,5	77,5-79,5	80,5-82,5	87,5-89,5	90,5-92,5	97,5-99,5



Trattamento anticalcare optional da inserire al momento dell'ordine € 50



Inquadrare il QR code per collegarsi alla pagina del sito www.samo.it per vedere altre combinazioni di pannelli e vetri



196,5
cm

6
mm



Finitura pannelli

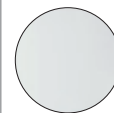

TR
Trasparente

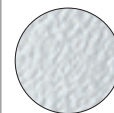

ST
Stampato

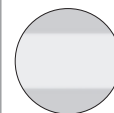

RF
Trasparente con fascia satinata
H 100 cm.

Profili in alluminio



ULU
Brillantato cromo

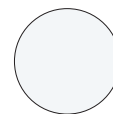

L91
Bianco opaco

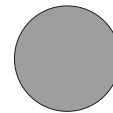

L95
Grigio opaco



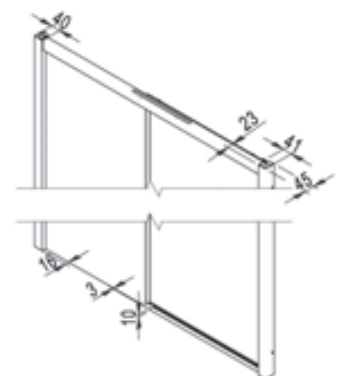
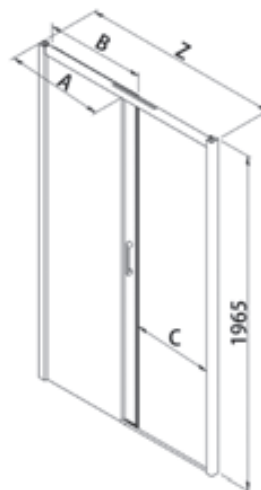
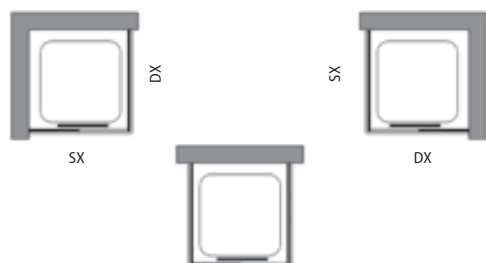

L96
Nero opaco

Porta scorrevole a due ante. Apertura laterale ad anta scorrevole, una fissa ed una apribile.



Le dimensioni sono espresse in mm.

Z [cm]	Cod.	A [cm]	B [cm]	C [cm]	 [dm³]	 [kg]	 [n°]	Pannelli	ULU [€]	L91-L95-L96 [€]
97-101	B0780	45,3-47,3	48,9	37	116	35	1	TR	791	791
								ST	831	831
								RF	910	910
107-111	B0781	55,3-57,3	48,9	37	124	37	1	TR	815	815
								ST	856	856
								RF	938	938
117-121	B0783	55,3-57,3	58,9	47	125	38	1	TR	841	841
								ST	884	884
								RF	968	968
127-131	B0785	65,1-67,1	58,9	47	131	39	2	TR	858	858
								ST	901	901
								RF	987	987
137-141	B0786	65,1-67,1	69,1	57	138	40	2	TR	907	907
								ST	953	953
								RF	1044	1044
147-151	B0787	69,6-71,6	74,6	63	143	41	2	TR	934	934
								ST	981	981
								RF	1075	1075
157-161	B0789	76,6-78,6	77,6	66	149	42	2	TR	958	958
								ST	1006	1006
								RF	1102	1102
167-171	B0790	80,1-82,1	84,1	73	149	44	2	TR	985	985
								ST	1035	1035
								RF	1133	1133

Tempi di consegna

1-2 settimane

2-3 settimane

3-4 settimane

Per il trattamento StarClean considerare un aumento di una settimana dei tempi di consegna.

Prodotti Speciali	Misure limite	I [€]	II [€]	III [€]
	H max 200 cm / L max 180 cm - min 80 cm	125	160	190

Modulo di richiesta disponibile on-line sul sito: www.samo.it/it/prodotti-speciali - In caso di annullamento dopo l'accettazione, sarà addebitato il costo totale dell'ordine.

Profilo di compensazione optional

Altezza [cm]	Cod.	Estensibilità [cm]	ULU [€]	L96 [€]	L91-L95 [€]
196,5	COM10B	0-3	90	90	90

Soft Closing	[€]
RIC2849	53

Parete fissa per abbinamenti (pag. 220-1)

Cod.	B0724	B0725	B0760	B0726	B0727	B0728	B0761	B0729
Estensibilità	67,5-69,5	70,5-72,5	75,5-77,5	77,5-79,5	80,5-82,5	87,5-89,5	90,5-92,5	97,5-99,5



Trattamento anticalcare optional da inserire al momento dell'ordine € 50

Inquadrare il QR code per collegarsi alla pagina del sito www.samo.it per vedere altre combinazioni di pannelli e vetri



196,5
cm

6
mm



Finitura pannelli

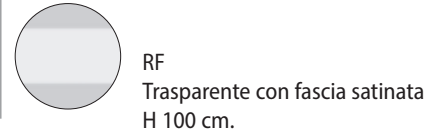
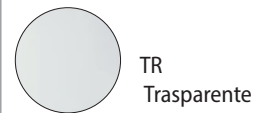

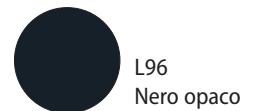

Profili in alluminio

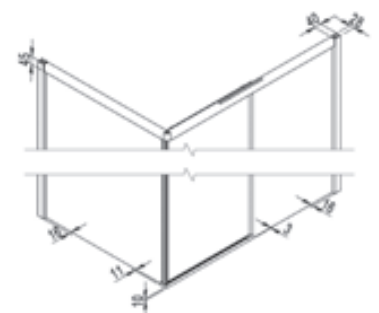
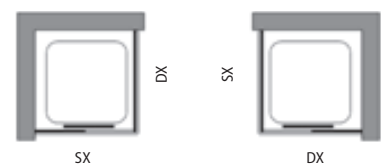
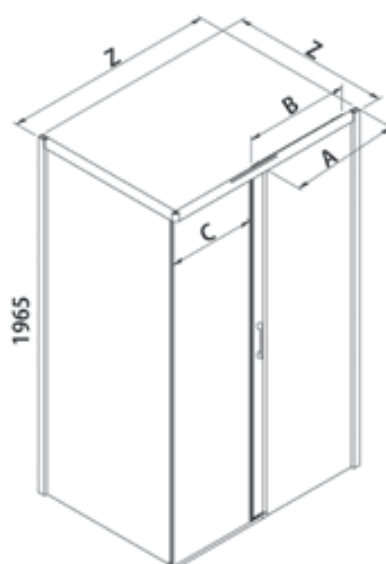

Porta scorrevole a due ante. Apertura laterale ad anta scorrevole, una fissa ed una apribile.
Porta scorrevole installabile solo con parete fissa dedicata. Non è possibile l'installazione a nicchia.



Le dimensioni sono espresse in mm.

Z [cm]	Cod.	A [cm]	B [cm]	C [cm]	 [dm ³]	 [kg]	 [n°]	Pannelli	ULU [€]	L91-L95-L96 [€]
97,5-99,5	B0770	48,6-50,6	48,9	38	116	35	1	TR	769	769
								ST	808	808
								RF	885	885
107,5-109,5	B0771	58,6-60,6	48,9	38	124	37	1	TR	792	792
								ST	832	832
								RF	911	911
117,5-119,5	B0773	58,6-60,6	58,9	48	125	38	1	TR	814	814
								ST	855	855
								RF	937	937
127,5-129,5	B0775	68,6-70,6	58,9	48	131	39	2	TR	835	835
								ST	877	877
								RF	961	961
137,5-139,5	B0776	68,6-70,6	69,1	58	138	40	2	TR	884	884
								ST	929	929
								RF	1017	1017
147,5-149,5	B0777	73,3-75,3	74,6	63	143	41	2	TR	907	907
								ST	953	953
								RF	1044	1044
157,5-159,5	B0779	80,1-82,1	77,6	66	149	42	2	TR	940	940
								ST	987	987
								RF	1081	1081
167,5-169,5	B0772	83,6-85,6	84,1	73	149	44	2	TR	976	976
								ST	1025	1025
								RF	1123	1123
Parete fissa										
67,5-69,5	B0791	//	//	//	116	35	1	TR	376	376
								ST	395	395
								RF	433	433
70,5-72,5	B0792	//	//	//	124	37	1	TR	382	382
								ST	402	402
								RF	440	440
75,5-77,5	B0793	//	//	//	125	38	1	TR	389	389
								ST	409	409
								RF	448	448
77,5-79,5	B0794	//	//	//	131	39	1	TR	393	393
								ST	413	413
								RF	452	452
80,5-82,5	B0795	//	//	//	138	40	1	TR	404	404
								ST	425	425
								RF	465	465
87,5-89,5	B0796	//	//	//	143	41	1	TR	416	416
								ST	437	437
								RF	479	479
90,5-92,5	B0797	//	//	//	149	42	1	TR	427	427
								ST	449	449
								RF	492	492
97,5-99,5	B0798	//	//	//	149	44	1	TR	437	437
								ST	459	459
								RF	503	503
Tempi di consegna					1-2 settimane		2-3 settimane		3-4 settimane	

Per il trattamento StarClean considerare un aumento di una settimana dei tempi di consegna.

Prodotti Speciali	Misure limite	I [€]	II [€]	III [€]
Porta	H max 210 cm / L max 200 cm - min 90 cm	125	160	190
Parete fissa	H max 210 cm / L max 120 cm - min 20 cm	70	90	105

Modulo di richiesta disponibile on-line sul sito: www.samo.it/it/prodotti-speciali - In caso di annullamento dopo l'accettazione, sarà addebitato il costo totale dell'ordine.



Trattamento anticalcare optional da inserire al momento dell'ordine € 50



Inquadrare il QR code per collegarsi alla pagina del sito
www.samo.it per vedere altre combinazioni di pannelli e vetri

196,5
cm

6
mm



Finitura pannelli

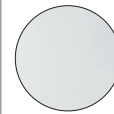

TR
Trasparente

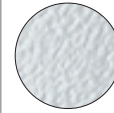

ST
Stampato

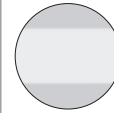

RF
Trasparente con fascia satinata
H 100 cm.

Profili in alluminio



ULU
Brillantato cromo

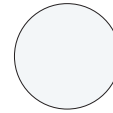

L91
Bianco opaco

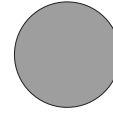

L95
Grigio opaco



L96
Nero opaco

Porta scorrevole a quattro ante, con apertura centrale ad ante scorrevoli, due fisse e due apribili.

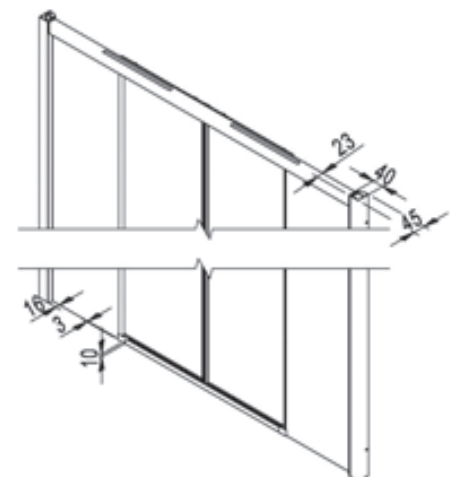
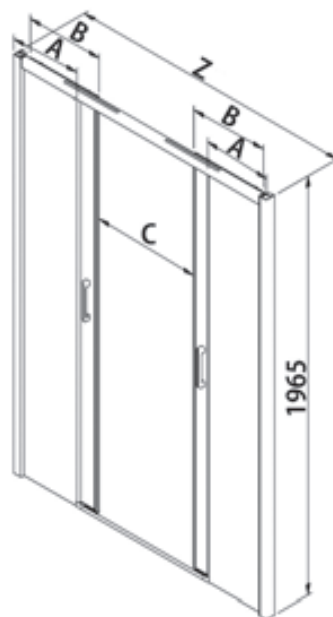

Le dimensioni sono espresse in mm.

Z [cm]	Cod.	A [cm]	B [cm]	C [cm]	 [dm³]	 [kg]	 [n°]	Pannelli	ULU [€]	L91-L95-L96 [€]
137-141	B0744	33,3-35,3	37,1	52	161	51	2	TR	1079	1079
								ST	1133	1133
								RF	1241	1241
142-146	B0745	35,8-37,8	37,1	52	165	52	2	TR	1091	1091
								ST	1146	1146
								RF	1255	1255
157-161	B0746	38,3-40,3	42,1	62	170	54	2	TR	1129	1129
								ST	1186	1186
								RF	1299	1299
162-166	B0740	40,8-42,8	42,1	62	172	55	2	TR	1142	1142
								ST	1200	1200
								RF	1314	1314
167-171	B0747	40,8-42,8	44,6	67	173	56	2	TR	1150	1150
								ST	1208	1208
								RF	1323	1323
172-176	B0741	43,3-45,3	44,6	67	178	57	2	TR	1160	1160
								ST	1218	1218
								RF	1334	1334
177-181	B0748	43,3-45,3	47,1	72	183	58	2	TR	1170	1170
								ST	1229	1229
								RF	1346	1346
Tempi di consegna					1-2 settimane	2-3 settimane	3-4 settimane			

Per il trattamento StarClean considerare un aumento di una settimana dei tempi di consegna.

Prodotti Speciali	Misure limite	I [€]	II [€]	III [€]
	H max 200 cm / L max 200 cm - min 100 cm	180	210	250

Modulo di richiesta disponibile on-line sul sito: www.samo.it/it/prodotti-speciali - In caso di annullamento dopo l'accettazione, sarà addebitato il costo totale dell'ordine.

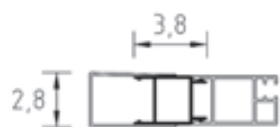

Profilo di compensazione optional

Altezza [cm]	Cod.	Estensibilità [cm]	ULU [€]	L96 [€]	L91-L95 [€]
196,5	COM10B	0-3	90	90	90

Soft Closing	[€]
RIC2849	53
Sistema di chiusura Soft Closing, optional solo su richiesta	

Parete fissa per abbinamenti (pag. 220-1)								
Cod.	B0724	B0725	B0760	B0726	B0727	B0728	B0761	B0729
Estensibilità	67,5-69,5	70,5-72,5	75,5-77,5	77,5-79,5	80,5-82,5	87,5-89,5	90,5-92,5	97,5-99,5





Trattamento anticalcare optional da inserire al momento dell'ordine € 100



Inquadrare il QR code per collegarsi alla pagina del sito www.samo.it per vedere altre combinazioni di pannelli e vetri

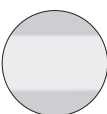

Finitura pannelli

-  TR
Trasparente
-  ST
Stampato
-  RF
Trasparente con fascia satinata
H 100 cm.

Profili in alluminio

-  ULU
Brillantato cromo
-  L91
Bianco opaco
-  L95
Grigio opaco
-  L96
Nero opaco

Parete fissa per abbinamenti, è possibile formare cabine doccia a due o tre lati, anche misure rettangolari.



SX



DX

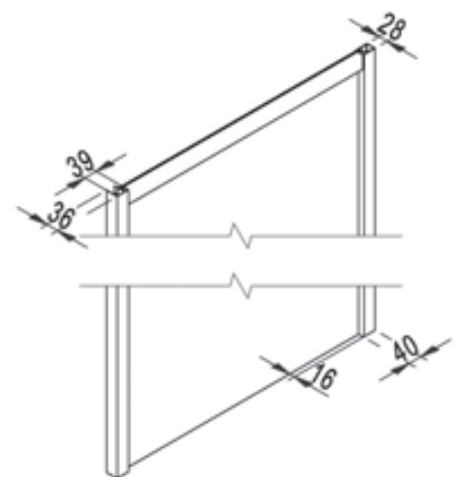

Le dimensioni sono espresse in mm.

Z [cm]	Cod.	A [cm]	B [cm]	C [cm]	 [dm³]	 [kg]	 [n°]	Pannelli	ULU [€]	L91-L95-L96 [€]
67,5-69,5	B0724	//	//	//	116	23	1	TR	376	376
								ST	395	395
								RF	433	433
70,5-72,5	B0725	//	//	//	117	23,5	1	TR	382	382
								ST	402	402
								RF	440	440
75,5-77,5	B0760	//	//	//	118	24	1	TR	389	389
								ST	409	409
								RF	448	448
77,5-79,5	B0726	//	//	//	122	25	1	TR	393	393
								ST	413	413
								RF	452	452
80,5-82,5	B0727	//	//	//	124	26	1	TR	404	404
								ST	425	425
								RF	465	465
87,5-89,5	B0728	//	//	//	130	27	1	TR	416	416
								ST	437	437
								RF	479	479
90,5-92,5	B0761	//	//	//	130	29	1	TR	427	427
								ST	449	449
								RF	492	492
97,5-99,5	B0729	//	//	//	136	30	1	TR	437	437
								ST	459	459
								RF	503	503

Tempi di consegna

1-2 settimane

2-3 settimane

3-4 settimane

Per il trattamento StarClean considerare un aumento di una settimana dei tempi di consegna.

Possibili combinazioni



Prodotti Speciali	Misure limite	I [€]	II [€]	III [€]
Parete fissa	H max 210 cm / L max 120 cm - min 20 cm	70	90	105

Modulo di richiesta disponibile on-line sul sito: www.samo.it/it/prodotti-speciali - In caso di annullamento dopo l'accettazione, sarà addebitato il costo totale dell'ordine.



Profilo di compensazione optional

Altezza [cm]	Cod.	Estensibilità [cm]	ULU [€]	L96 [€]	L91-L95 [€]
196,5	COM10B	0-3	90	90	90



Treatmento anticalcare optional da inserire al momento dell'ordine € 50



Inquadrare il QR code per collegarsi alla pagina del sito www.samo.it per vedere altre combinazioni di pannelli e vetri

Cee Art





Cee Art

B0920ULUST



B0986L95TR



PLUS DI PRODOTTO



- H 195 cm – V 6 mm
- 2 cm di regolazione del fuorisquadra
- Prodotto reversibile
- Ampiezza di gamma completa
- Copertura completa delle misure
- Sgancio anta scorrevole per facilitare la pulizia
- Carter copertura viti a muro
- Interasse maniglia 160 mm
- Anticalcare optional, solo su richiesta
- Stampa digitale disponibile su tutti i vetri piani TR





Cee Art



Finitura pannelli

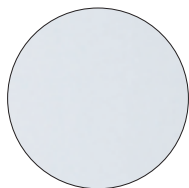

TR
Trasparente

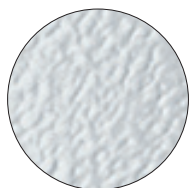

ST
Stampato

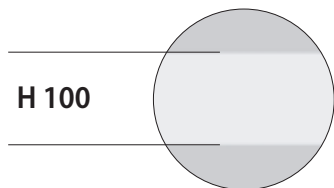

H 100

RF
Trasparente con fascia satinata H. 100 cm.

Profili in alluminio

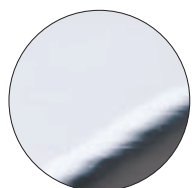

ULU
Brillantato cromo

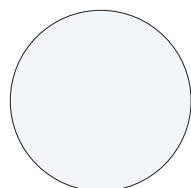

L91
Bianco opaco

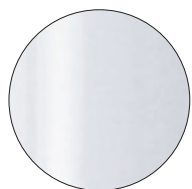

L01
Bianco

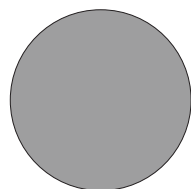

L95
Grigio opaco

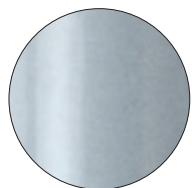

SAR
Satinato Argento

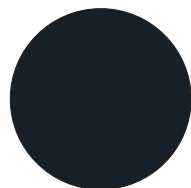

L96
Nero opaco

Angolo

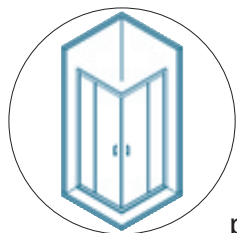

p. 230

Tondo



p. 242

Parete fissa

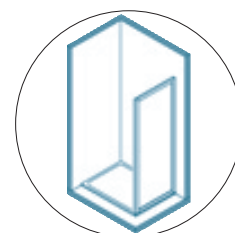

p. 244

Porta

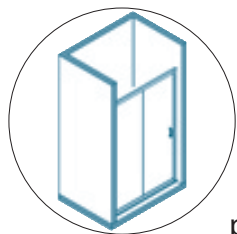

p. 232

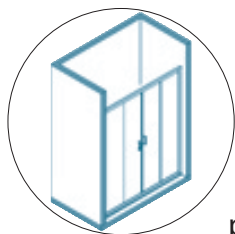

p. 234

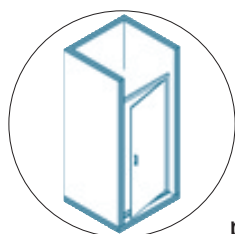

p. 236

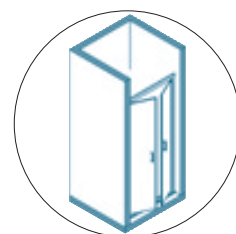

p. 238

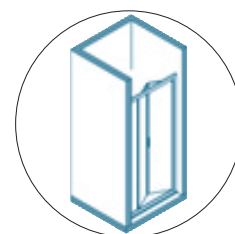



p. 240



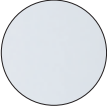

-  195
cm
-  6
mm
- 
- 
- 
- 
- 
- 
- 
- 

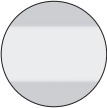
Finitura pannelli

-  TR
Trasparente
-  ST
Stampato
-  RF
Trasparente con fascia satinata
H 100 cm.

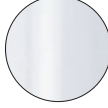
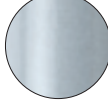
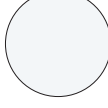
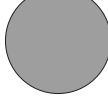

Profili in alluminio

-  ULU
Brillantato cromo
-  L01
Bianco
-  SAR
Satinato Argento
-  L91
Bianco opaco
-  L95
Grigio opaco
-  L96
Nero opaco

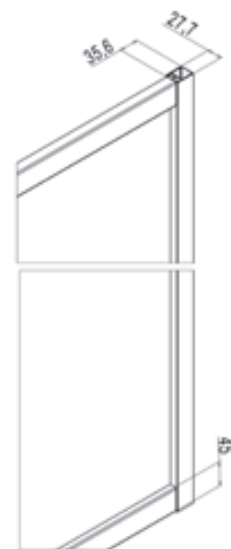
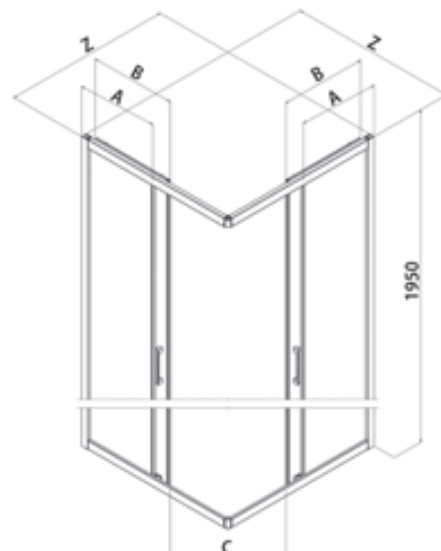
Angolo a quattro ante, apertura ad ante scorrevoli, due fisse e due apribili. Reversibile all'atto dell'installazione.



Le dimensioni sono espresse in mm.

Z [cm]	Cod.	A [cm]	B [cm]	C [cm]	 [dm³]	 [kg]	 [n°]	Pannelli	L01 [€]	SAR [€]	ULU [€]	L91-L95-L96 [€]
67-69	B0916 [1 Lato]	30,6-32,6	34,3	35	112	26	1	TR	427	512	512	512
								ST	449	538	538	538
								RF	492	589	589	589
70-72	B0914 [1 Lato]	31,1-33,6	36,8	39	115	28	1	TR	432	519	519	519
								ST	454	545	545	545
								RF	497	597	597	597
72-74	B0917 [1 Lato]	33,1-35,1	36,8	39	122	28	1	TR	437	524	524	524
								ST	459	551	551	551
								RF	503	603	603	603
75-77	B0915 [1 Lato]	33,6-35,6	39,3	42	124	30	1	TR	443	532	532	532
								ST	466	559	559	559
								RF	510	612	612	612
77-79	B0918 [1 Lato]	35,6-37,6	39,3	42	130	30	1	TR	448	537	537	537
								ST	471	564	564	564
								RF	516	618	618	618
80-82	B0919 [1 Lato]	37,1-39,1	40,8	45	136	30	1	TR	459	550	550	550
								ST	482	578	578	578
								RF	528	633	633	633
87-89	B0920 [1 Lato]	40,6-42,6	44,3	49	144	35	1	TR	470	564	564	564
								ST	494	593	593	593
								RF	541	649	649	649
90-92	B0922 [1 Lato]	42,1-44,1	45,8	52	152	35	1	TR	483	576	576	576
								ST	508	605	605	605
								RF	556	663	663	663
97-99	B0921 [1 Lato]	45,6-47,6	49,3	56	160	38	1	TR	493	587	587	587
								ST	518	617	617	617
								RF	567	676	676	676
117-119	B0923 [1 Lato]	65,6-67,6	49,3	56	175	41	1	TR	542	645	645	645
								ST	570	678	678	678
								RF	624	742	742	742

Tempi di consegna

1-2 settimane

2-3 settimane

3-4 settimane

N.B. I valori della tabella prezzi si riferiscono ad un singolo lato: sommare l'importo dei due codici con la misura desiderata per ottenere il prezzo totale di un box doccia ad angolo quadrato o rettangolare.

Nota: apertura determinata con due lati della stessa misura.

Per il trattamento StarClean considerare un aumento di una settimana dei tempi di consegna.

Prodotti Speciali	Misure limite	I [€]	II [€]	III [€]
	H max 210 cm / L max 130 cm - min 50 cm	100	125	140

Modulo di richiesta disponibile on-line sul sito: www.samo.it/it/prodotti-speciali - In caso di annullamento dopo l'accettazione, sarà addebitato il costo totale dell'ordine.



Profilo di compensazione optional

Altezza [cm]	Cod.	Estensibilità [cm]	L01 [€]	ULU [€]	SAR-L91-L95-L96 [€]
195	COM10C	0-3	60	90	90

Parete fissa per abbinamenti (pag. 244-5)

Cod.	B0924	B0925	B0960	B0926	B0927	B0928	B0961	B0929
Estensibilità	67-69	70-72	75-77	77-79	80-82	87-89	90-92	97-99



Tattamento anticalcare optional da inserire al momento dell'ordine € 50



Inquadrare il QR code per collegarsi alla pagina del sito www.samo.it per vedere altre combinazioni di pannelli e vetri

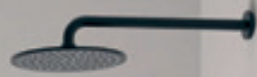

195
cm

6
mm



Finitura pannelli

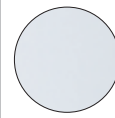

TR
Trasparente

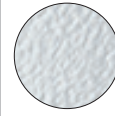

ST
Stampato

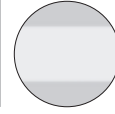

RF
Trasparente con fascia satinata
H 100 cm.

Profili in alluminio



ULU
Brillantato cromo

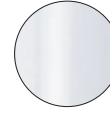

L01
Bianco

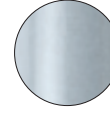

SAR
Satinato Argento

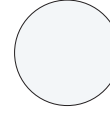

L91
Bianco opaco

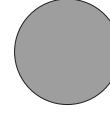

L95
Grigio opaco



L96
Nero opaco

Porta scorrevole a due ante. Apertura laterale ad anta scorrevole, una fissa ed una apribile.

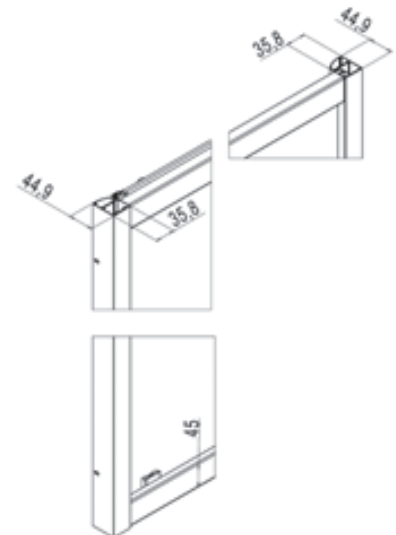

Le dimensioni sono espresse in mm.

Z [cm]	Cod.	A [cm]	B [cm]	C [cm]	 [dm³]	 [kg]	 [n°]	Pannelli	L01 [€]	SAR [€]	ULU [€]	L91-L95-L96 [€]
97-101	B0980	46,6-48,6	47,8	38	116	35	1	TR	594	713	713	713
								ST	624	749	749	749
								RF	684	820	820	820
107-111	B0981	53,6-55,6	50,8	41	124	37	1	TR	613	734	734	734
								ST	644	771	771	771
								RF	705	845	845	845
117-121	B0983	56,6-58,6	57,8	48	125	38	1	TR	630	754	754	754
								ST	662	792	792	792
								RF	725	868	868	868
127-131	B0985	63,9-65,9	60,8	50	131	39	1	TR	646	772	772	772
								ST	679	811	811	811
								RF	743	888	888	888
137-141	B0986	66,6-68,6	67,8	58	138	40	2	TR	684	820	820	820
								ST	719	861	861	861
								RF	787	943	943	943
147-151	B0987	71,6-73,6	72,8	63	143	41	2	TR	704	841	841	841
								ST	740	884	884	884
								RF	810	968	968	968
157-161	B0989	76,6-78,6	77,8	68	149	42	2	TR	722	863	863	863
								ST	759	907	907	907
								RF	831	993	993	993
167-171	B0990	81,6-83,6	82,8	73	149	44	2	TR	744	889	889	889
								ST	782	934	934	934
								RF	856	1023	1023	1023

Tempi di consegna

1-2 settimane

2-3 settimane

3-4 settimane

Per il trattamento StarClean considerare un aumento di una settimana dei tempi di consegna.

Prodotti Speciali	Misure limite	I [€]	II [€]	III [€]
	H max 210 cm / L max 180 cm - min 80 cm	125	160	190

Modulo di richiesta disponibile on-line sul sito: www.samo.it/it/prodotti-speciali - In caso di annullamento dopo l'accettazione, sarà addebitato il costo totale dell'ordine.

Profilo di compensazione optional

Altezza [cm]	Cod.	Estensibilità [cm]	L01 [€]	ULU [€]	SAR-L91-L95-L96 [€]
195	COM10C	0-3	60	90	90

Parete fissa per abbinamenti (pag. 244-5)

Cod.	B0924	B0925	B0960	B0926	B0927	B0928	B0961	B0929
Estensibilità	67-69	70-72	75-77	77-79	80-82	87-89	90-92	97-99



Trattamento anticalcare optional da inserire al momento dell'ordine € 50

Inquadrare il QR code per collegarsi alla pagina del sito www.samo.it per vedere altre combinazioni di pannelli e vetri



195
cm

6
mm



Finitura pannelli

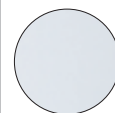

TR
Trasparente

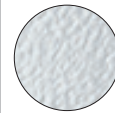

ST
Stampato

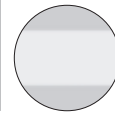

RF
Trasparente con fascia satinata
H 100 cm.

Profili in alluminio



ULU
Brillantato cromo

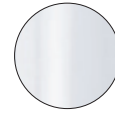

L01
Bianco

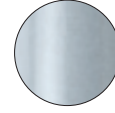

SAR
Satinato Argento

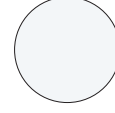

L91
Bianco opaco

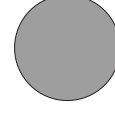

L95
Grigio opaco



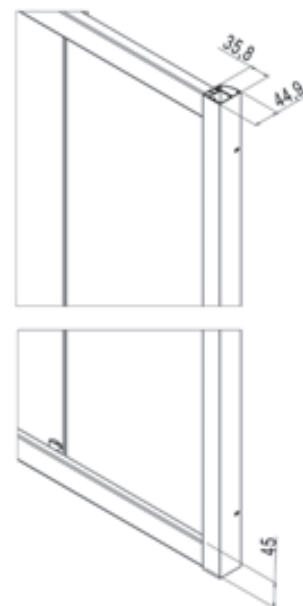
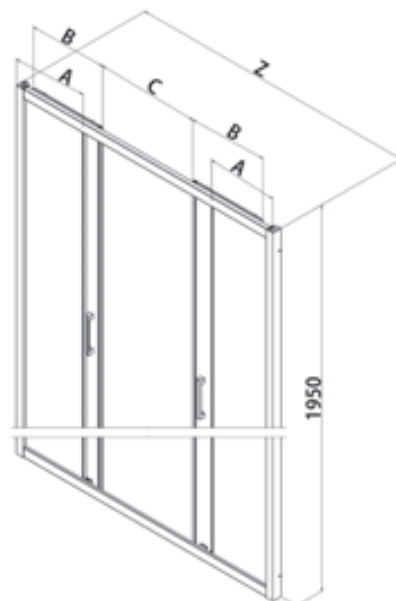

L96
Nero opaco

Porta scorrevole a quattro ante, con apertura centrale ad ante scorrevoli, due fisse e due apribili.



Le dimensioni sono espresse in mm.

Z [cm]	Cod.	A [cm]	B [cm]	C [cm]	 [dm ³]	 [kg]	 [n°]	Pannelli	L01 [€]	SAR [€]	ULU [€]	L91-L95-L96 [€]
137-141	B0944	34,1-36,1	36,8	54	161	51	2	TR	813	972	972	972
								ST	854	1021	1021	1021
								RF	935	1118	1118	1118
142-146	B0945	37,1	36,8	54	165	52	2	TR	821	983	983	983
								ST	863	1033	1033	1033
								RF	945	1131	1131	1131
157-161	B0946	39,1-41,1	41,8	64	170	54	2	TR	846	1018	1018	1018
								ST	889	1069	1069	1069
								RF	973	1171	1171	1171
162-166	B0940	41,6	41,8	64	172	55	2	TR	857	1027	1027	1027
								ST	900	1079	1079	1079
								RF	986	1182	1182	1182
167-171	B0947	41,6-43,6	44,3	69	173	56	2	TR	866	1037	1037	1037
								ST	910	1089	1089	1089
								RF	996	1193	1193	1193
172-176	B0941	45,1	44,3	69	178	57	2	TR	875	1046	1046	1046
								ST	919	1099	1099	1099
								RF	1007	1203	1203	1203
177-181	B0948	43,1-45,1	47,8	72	183	58	2	TR	885	1056	1056	1056
								ST	930	1109	1109	1109
								RF	1018	1215	1215	1215
Tempi di consegna						1-2 settimane		2-3 settimane		3-4 settimane		

Per il trattamento StarClean considerare un aumento di una settimana dei tempi di consegna.

Prodotti Speciali	Misure limite	I [€]	II [€]	III [€]
	H max 210 cm / L max 200 cm - min 100 cm	180	210	250

Modulo di richiesta disponibile on-line sul sito: www.samo.it/it/prodotti-speciali - In caso di annullamento dopo l'accettazione, sarà addebitato il costo totale dell'ordine.



Profilo di compensazione optional

Altezza [cm]	Cod.	Estensibilità [cm]	L01 [€]	ULU [€]	SAR-L91-L95-L96 [€]
195	COM10C	0-3	60	90	90

Parete fissa per abbinamenti (pag. 244-5)

Cod.	B0924	B0925	B0960	B0926	B0927	B0928	B0961	B0929
Estensibilità	67-69	70-72	75-77	77-79	80-82	87-89	90-92	97-99





Trattamento anticalcare optional da inserire al momento dell'ordine € 100





Inquadrare il QR code per collegarsi alla pagina del sito www.samo.it per vedere altre combinazioni di pannelli e vetri

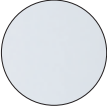

Finitura pannelli

-  TR
Trasparente
-  ST
Stampato
-  RF
Trasparente con fascia satinata
H 100 cm.

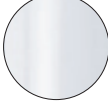
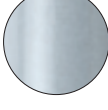
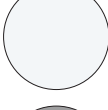
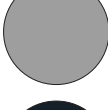
Profili in alluminio

-  ULU
Brillantato cromo
-  L01
Bianco
-  SAR
Satinato Argento
-  L91
Bianco opaco
-  L95
Grigio opaco
-  L96
Nero opaco

Porta ad un'anta a battente con apertura verso l'interno e l'esterno.

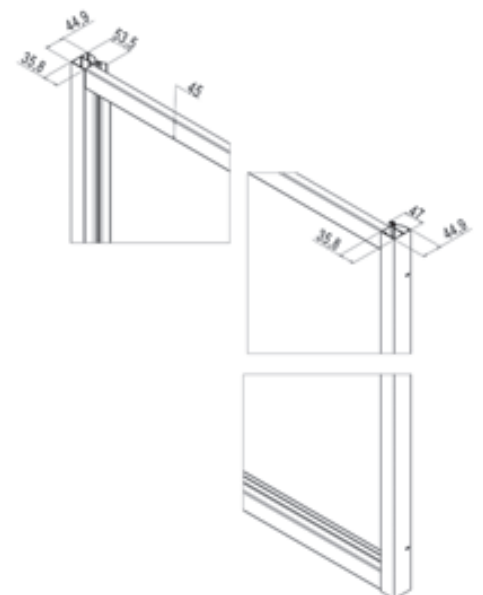
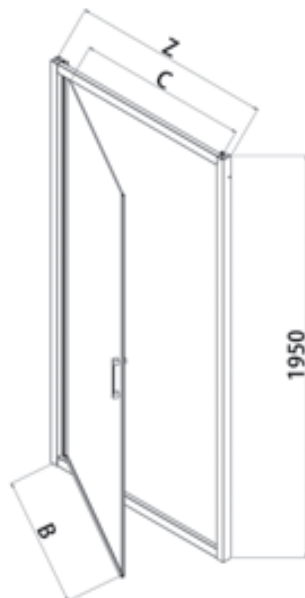

Le dimensioni sono espresse in mm.

Z [cm]	Cod.	A [cm]	B [cm]	C [cm]	 [dm³]	 [kg]	 [n°]	Pannelli	L01 [€]	SAR [€]	ULU [€]	L91-L95-L96 [€]
62-66	B0900	//	47,9	50	112	23	1	TR	480	577	577	577
								ST	504	606	606	606
								RF	552	664	664	664
67-71	B0901	//	52,9	55	115	24	1	TR	489	587	587	587
								ST	514	617	617	617
								RF	563	676	676	676
72-76	B0905	//	57,9	60	125	26	1	TR	497	599	599	599
								ST	522	629	629	629
								RF	572	689	689	689
77-81	B0902	//	62,9	65	131	27	1	TR	507	610	610	610
								ST	533	641	641	641
								RF	584	702	702	702
82-86	B0906	//	67,9	70	141	28	1	TR	516	620	620	620
								ST	542	651	651	651
								RF	594	713	713	713
87-91	B0903	//	72,9	75	151	29	1	TR	524	631	631	631
								ST	551	663	663	663
								RF	603	726	726	726
97-101	B0904	//	82,9	85	156	31	1	TR	543	648	648	648
								ST	571	681	681	681
								RF	625	746	746	746
Tempi di consegna						1-2 settimane		2-3 settimane		3-4 settimane		

Per il trattamento StarClean considerare un aumento di una settimana dei tempi di consegna.

Prodotti Speciali	Misure limite	I [€]	II [€]	III [€]
	H max 210 cm / L max 101 cm - min 50 cm	100	125	140

Modulo di richiesta disponibile on-line sul sito: www.samo.it/it/prodotti-speciali - In caso di annullamento dopo l'accettazione, sarà addebitato il costo totale dell'ordine.



Profilo di compensazione optional

Altezza [cm]	Cod.	Estensibilità [cm]	L01 [€]	ULU [€]	SAR-L91-L95-L96 [€]
195	COM10C	0-3	60	90	90

Parete fissa per abbinamenti (pag. 244-5)

Cod.	B0924	B0925	B0960	B0926	B0927	B0928	B0961	B0929
Estensibilità	67-69	70-72	75-77	77-79	80-82	87-89	90-92	97-99



Tattamento anticalcare optional da inserire al momento dell'ordine € 50



Inquadrare il QR code per collegarsi alla pagina del sito www.samo.it per vedere altre combinazioni di pannelli e vetri



- 195 cm
- 6 mm
- 3D view
- Shower tray
- Handles
- Vertical bars
- Plus sign
- Water drop

Finitura pannelli

- TR
Trasparente
- ST
Stampato
- RF
Trasparente con fascia satinata
H 100 cm.

Profili in alluminio

- ULU
Brillantato cromo
- L01
Bianco
- SAR
Satinato Argento
- L91
Bianco opaco
- L95
Grigio opaco
- L96
Nero opaco

Porta a saloon, apertura ad ante battenti verso l'interno e verso l'esterno.

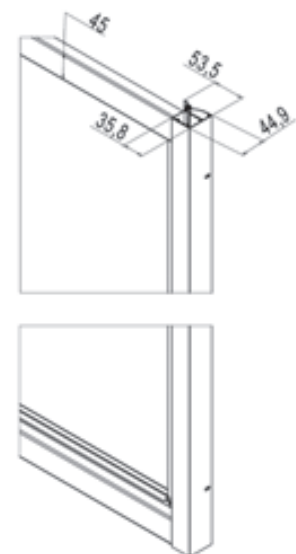

Le dimensioni sono espresse in mm.

Z [cm]	Cod.	A [cm]	B [cm]	C [cm]	 [dm³]	 [kg]	 [n°]	Pannelli	L01 [€]	SAR [€]	ULU [€]	L91-L95-L96 [€]
67-71	B0930	//	24,2	52	114	24	1	TR	512	615	615	615
								ST	538	646	646	646
								RF	589	708	708	708
72-76	B0931	//	26,7	57	122	25	1	TR	521	624	624	624
								ST	548	656	656	656
								RF	600	718	718	718
77-81	B0932	//	29,2	62	139	28	1	TR	529	634	634	634
								ST	556	666	666	666
								RF	609	730	730	730
82-86	B0937	//	31,7	67	149	30	1	TR	538	645	645	645
								ST	565	678	678	678
								RF	619	742	742	742
87-91	B0933	//	34,2	72	152	31	1	TR	546	654	654	654
								ST	574	687	687	687
								RF	628	753	753	753
92-96	B0938	//	36,7	77	162	32	1	TR	556	666	666	666
								ST	584	700	700	700
								RF	640	766	766	766
97-101	B0934	//	39,2	82	178	35	1	TR	564	674	674	674
								ST	593	708	708	708
								RF	649	776	776	776
107-111	B0935	//	44,2	92	162	33	1	TR	580	691	691	691
								ST	609	726	726	726
								RF	667	795	795	795
117-121	B0936	//	49,2	102	163	34	1	TR	598	711	711	711
								ST	628	747	747	747
								RF	688	818	818	818

Tempi di consegna

1-2 settimane

2-3 settimane

3-4 settimane

Per il trattamento StarClean considerare un aumento di una settimana dei tempi di consegna.

Prodotti Speciali	Misure limite	I [€]	II [€]	III [€]
	H max 210 cm / L max 121 cm - min 50 cm	110	150	180

Modulo di richiesta disponibile on-line sul sito: www.samo.it/it/prodotti-speciali - In caso di annullamento dopo l'accettazione, sarà addebitato il costo totale dell'ordine.

Profilo di compensazione optional

Altezza [cm]	Cod.	Estensibilità [cm]	L01 [€]	ULU [€]	SAR-L91-L95-L96 [€]
195	COM10C	0-3	60	90	90

Parete fissa per abbinamenti (pag. 244-5)

Cod.	B0924	B0925	B0960	B0926	B0927	B0928	B0961	B0929
Estensibilità	67-69	70-72	75-77	77-79	80-82	87-89	90-92	97-99





Trattamento anticalcare optional da inserire al momento dell'ordine € 50

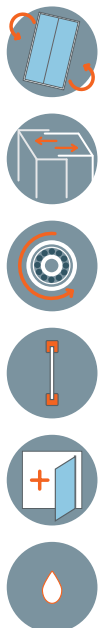

Inquadrare il QR code per collegarsi alla pagina del sito www.samo.it per vedere altre combinazioni di pannelli e vetri

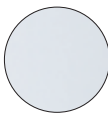

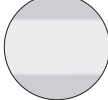
Finitura pannelli

-  TR
Trasparente
-  ST
Stampato
-  RF
Trasparente con fascia satinata
H 100 cm.

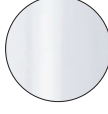
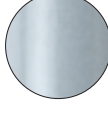
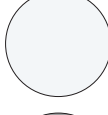
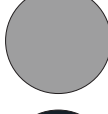
Profili in alluminio

-  ULU
Brillantato cromo
-  L01
Bianco
-  SAR
Satinato Argento
-  L91
Bianco opaco
-  L95
Grigio opaco
-  L96
Nero opaco

Porta a due ante a soffietto, apertura con ante pieghevoli verso l'interno.

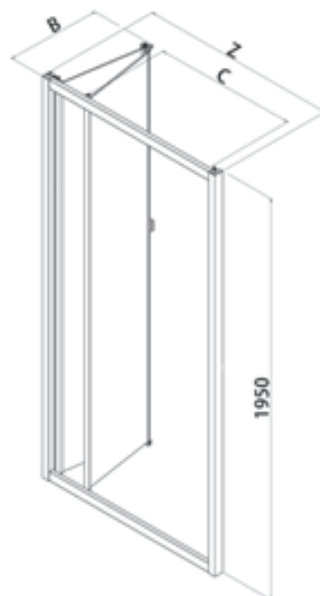

Le dimensioni sono espresse in mm.

Z [cm]	Cod.	A [cm]	B [cm]	C [cm]	 [dm ³]	 [kg]	 [n°]	Pannelli	L01 [€]	SAR [€]	ULU [€]	L91-L95-L96 [€]
67-71	B0907	//	32,5	41	120	25	1	TR	675	811	811	811
								ST	709	852	852	852
								RF	777	933	933	933
72-76	B0908	//	35	46	124	27	1	TR	685	823	823	823
								ST	720	865	865	865
								RF	788	947	947	947
77-81	B0909	//	37,7	50	133	28	1	TR	695	834	834	834
								ST	730	876	876	876
								RF	800	960	960	960
82-86	B0912	//	40	56	142	30	1	TR	705	845	845	845
								ST	741	888	888	888
								RF	811	972	972	972
87-91	B0910	//	42,8	59	157	31	1	TR	715	858	858	858
								ST	751	901	901	901
								RF	823	987	987	987
92-96	B0913	//	45	66	156	33	1	TR	723	867	867	867
								ST	760	911	911	911
								RF	832	998	998	998
97-101	B0911	//	47,8	68	162	34	1	TR	733	874	874	874
								ST	770	918	918	918
								RF	843	1006	1006	1006
Tempi di consegna						1-2 settimane		2-3 settimane		3-4 settimane		

Per il trattamento StarClean considerare un aumento di una settimana dei tempi di consegna.

Prodotti Speciali	Misure limite	I [€]	II [€]	III [€]
		H max 210 cm / L max 101 cm - min 50 cm	130	160

Modulo di richiesta disponibile on-line sul sito: www.samo.it/it/prodotti-speciali - In caso di annullamento dopo l'accettazione, sarà addebitato il costo totale dell'ordine.



Profilo di compensazione optional

Altezza [cm]	Cod.	Estensibilità [cm]	L01 [€]	ULU [€]	SAR-L91-L95-L96 [€]
195	COM10C	0-3	60	90	90

Parete fissa per abbinamenti (pag. 244-5)

Cod.	B0924	B0925	B0960	B0926	B0927	B0928	B0961	B0929
Estensibilità	67-69	70-72	75-77	77-79	80-82	87-89	90-92	97-99



Tattamento anticalcare optional da inserire al momento dell'ordine € 50



Inquadrare il QR code per collegarsi alla pagina del sito www.samo.it per vedere altre combinazioni di pannelli e vetri



195
cm

6
mm



Finitura pannelli

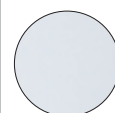

TR
Trasparente

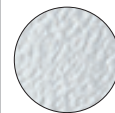

ST
Stampato

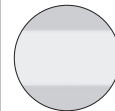

RF
Trasparente con fascia satinata
H 100 cm.

Profili in alluminio



ULU
Brillantato cromo

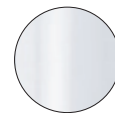

L01
Bianco

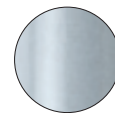

SAR
Satinato Argento

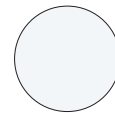

L91
Bianco opaco

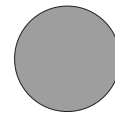

L95
Grigio opaco



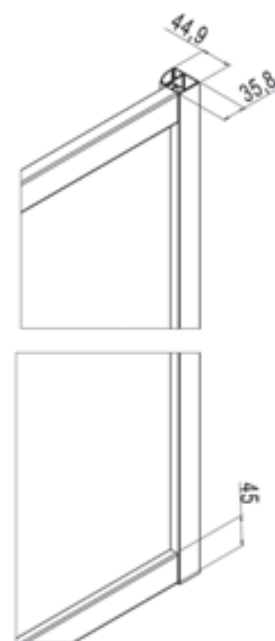
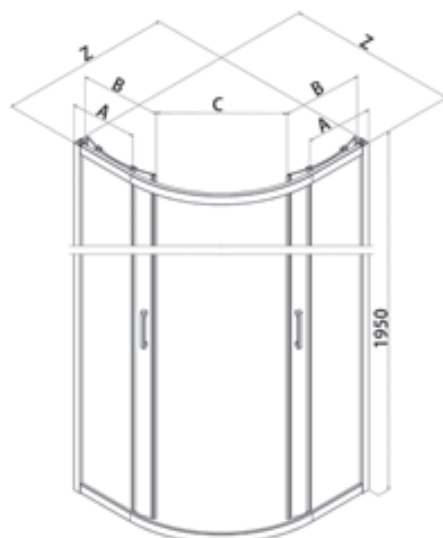

L96
Nero opaco

Tondo scorrevole a quattro ante, due fisse laterali e due apribili frontali.



Le dimensioni sono espresse in mm.

Z [cm]	Cod.	A [cm]	B [cm]	C [cm]	 [dm ³]	 [kg]	 [n°]	Pannelli	L01 [€]	SAR [€]	ULU [€]	L91-L95-L96 [€]
77-79	B0953	23,1-25,1	40	38	238	48	2	TR	923	1105	1105	1105
								ST	970	1161	1161	1161
								RF	1062	1271	1271	1271
87-89	B0952	33,1-35,1	40	51	273	54	2	TR	967	1161	1161	1161
								ST	1016	1220	1220	1220
								RF	1113	1336	1336	1336
97-99	B0954	43,1-45,1	40	51	330	61	2	TR	1046	1258	1258	1258
								ST	1099	1321	1321	1321
								RF	1203	1447	1447	1447
Tempi di consegna						1-2 settimane		2-3 settimane		3-4 settimane		

Per il trattamento StarClean considerare un aumento di una settimana dei tempi di consegna.

Prodotti Speciali	Misure limite	I [€]	II [€]	III [€]
Altezza / Larghezza richiedere fattibilità		275	//	350

Modulo di richiesta disponibile on-line sul sito: www.samo.it/it/prodotti-speciali - In caso di annullamento dopo l'accettazione, sarà addebitato il costo totale dell'ordine.



Profilo di compensazione optional

Altezza [cm]	Cod.	Estensibilità [cm]	L01 [€]	ULU [€]	SAR-L91-L95-L96 [€]
195	COM10C	0-3	60	90	90



Tattamento anticalcare optional da inserire al momento dell'ordine € 100



Inquadrare il QR code per collegarsi alla pagina del sito www.samo.it per vedere altre combinazioni di pannelli e vetri



- 195
cm
- 6
mm
-
-
-

Finitura pannelli

- TR
Trasparente
- ST
Stampato
- RF
Trasparente con fascia satinata
H 100 cm.

Profili in alluminio

- ULU
Brillantato cromo
- L01
Bianco
- SAR
Satinato Argento
- L91
Bianco opaco
- L95
Grigio opaco
- L96
Nero opaco

Parete fissa per abbinamenti, è possibile formare cabine doccia a due o tre lati, anche misure rettangolari.

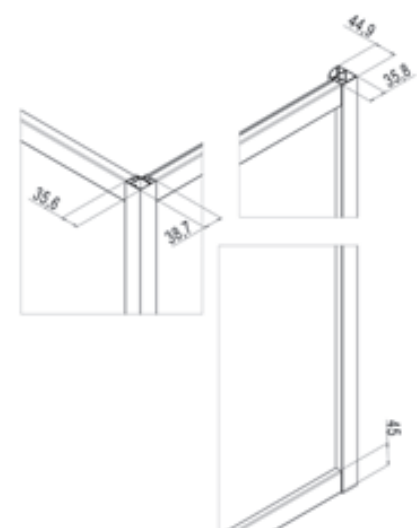

Le dimensioni sono espresse in mm.

Z [cm]	Cod.	A [cm]	B [cm]	C [cm]	 [dm³]	 [kg]	 [n°]	Pannelli	L01 [€]	SAR [€]	ULU [€]	L91-L95-L96 [€]
67-69	B0924	//	//	//	116	23	1	TR	300	359	359	359
								ST	315	377	377	377
								RF	345	413	413	413
70-72	B0925	//	//	//	117	23,5	1	TR	306	365	365	365
								ST	322	384	384	384
								RF	352	420	420	420
75-77	B0960	//	//	//	118	24	1	TR	311	372	372	372
								ST	327	391	391	391
								RF	358	428	428	428
77-79	B0926	//	//	//	122	25	1	TR	314	376	376	376
								ST	330	395	395	395
								RF	362	433	433	433
80-82	B0927	//	//	//	124	26	1	TR	322	386	386	386
								ST	339	406	406	406
								RF	371	444	444	444
87-89	B0928	//	//	//	130	27	1	TR	329	394	394	394
								ST	346	414	414	414
								RF	379	454	454	454
90-92	B0961	//	//	//	130	29	1	TR	342	409	409	409
								ST	360	430	430	430
								RF	394	471	471	471
97-99	B0929	//	//	//	136	30	1	TR	350	419	419	419
								ST	368	493	493	493
								RF	403	540	540	540

Tempi di consegna

1-2 settimane

2-3 settimane

3-4 settimane

Per il trattamento StarClean considerare un aumento di una settimana dei tempi di consegna.

Possibili combinazioni



Prodotti Speciali	Misure limite	I [€]	II [€]	III [€]
Parete fissa	H max 210 cm / L max 130 cm - min 50 cm	70	90	105

Modulo di richiesta disponibile on-line sul sito: www.samo.it/it/prodotti-speciali - In caso di annullamento dopo l'accettazione, sarà addebitato il costo totale dell'ordine.



Profilo di compensazione optional

Altezza [cm]	Cod.	Estensibilità [cm]	L01 [€]	ULU [€]	SAR-L91-L95-L96 [€]
195	COM10C	0-3	60	90	90



Trattamento anticalcare optional da inserire al momento dell'ordine € 50



Inquadrare il QR code per collegarsi alla pagina del sito www.samo.it per vedere altre combinazioni di pannelli e vetri

Polaris





Polaris



B3911L01RF



B3860_B3936L96TR



Polaris

B3891ULUTR



B3936L96AS

PLUS DI PRODOTTO



- H 195 cm – V 6 mm
- 2 cm di regolazione del fuorisquadra
- Profili verticali con fissaggio a pinza (gestione dell'estensibilità nascosta)
- Bordo lastra superiore in linea al telaio
- Snodo minimale con sollevamento
- Apertura interna-esterna
- Barra stabilizzatrice optional
- Profilo di compensazione dedicato
- Ampiezza di gamma completa
- Copertura completa delle misure
- Unica parete fissa per tutte le combinazioni
- Carter copertura viti a muro
- Interasse maniglia 160 mm
- Anticalcare optional, solo su richiesta
- Stampa digitale disponibile su tutti i vetri piani TR



- Maniglia optional, richiedere al momento dell'ordine





Polaris



Finitura pannelli

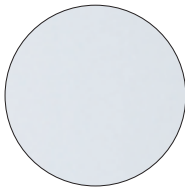

TR
Trasparente

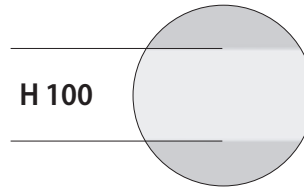

H 100

RF
Trasparente con fascia satinata H. 100 cm.

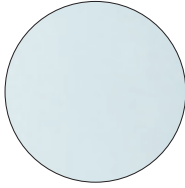

AS
Satinato Acqua

Profili in alluminio



ULU
Brillantato cromo

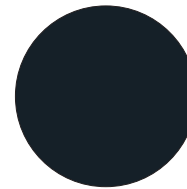

L96
Nero opaco



NEW
Bianco opaco

Angolo

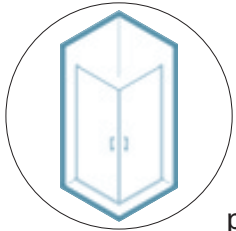

p. 254

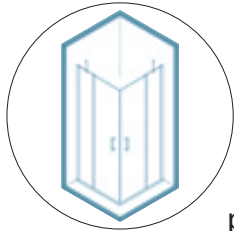

p. 258



p. 272

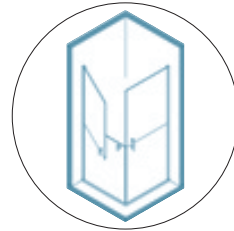

p. 276

Porta

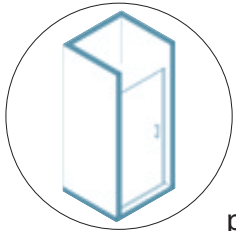

p. 256

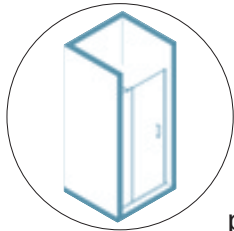

p. 260

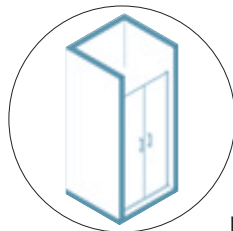

p. 262

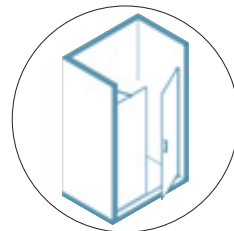

p. 264

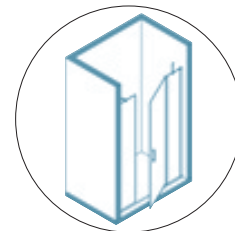

p. 266

Tondo

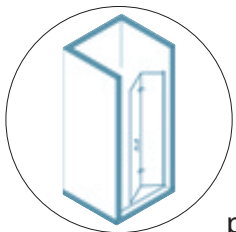

p. 274

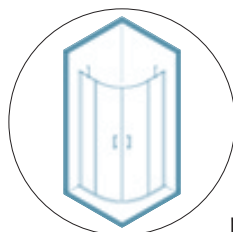

p. 268

Parete fissa

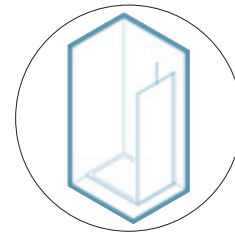



p. 270



-  195
cm
-  6
mm
- 
- 
- 
- 
- 
- 
- 
- 
- 
- 
- 

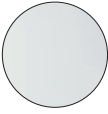
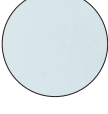

Finitura pannelli

-  TR
Trasparente
-  AS
Satinato Acqua
-  RF
Trasparente con fascia satinata
H 100 cm.

Profili in alluminio

-  ULU
Brillantato cromo
-  L91
Bianco opaco
-  L96
Nero opaco

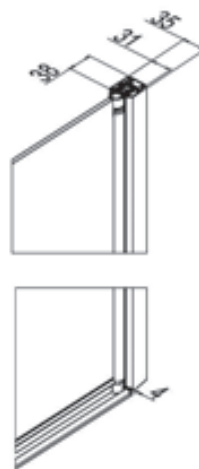
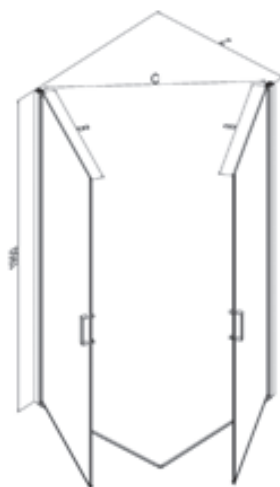
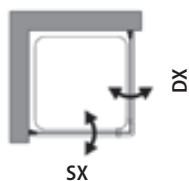
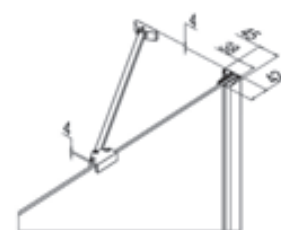

Angolo a due ante a battente, apribili verso l'esterno e verso l'interno.



Le dimensioni sono espresse in mm.

Kit abbinamento optional, per abbinamento con la parete fissa, da acquistare separatamente

Cod.	ULU [€]	L91 [€]	L96 [€]
140 cm. KT3920	135	135	135

Estensibilità Z [cm]	Cod.	Max ingombro Z+1,8 [cm]	B [cm]	C [cm]	 [dm³]	 [kg]	 [n°]	Pannelli	ULLU [€]	L91 [€]	L96 [€]
66-68	B3900 [1 Lato]	67,8-69,8	61,6	85	102	24	1	TR	507	507	507
								AS	685	685	685
								RF	584	584	584
68-70	B3901 [1 Lato]	69,8-71,8	63,6	88	106	24	1	TR	512	512	512
								AS	692	692	692
								RF	589	589	589
70-72	B3902 [1 Lato]	71,8-73,8	65,6	91	108	24	1	TR	516	516	516
								AS	697	697	697
								RF	594	594	594
72-74	B3903 [1 Lato]	73,8-75,8	67,6	93	112	24	1	TR	523	523	523
								AS	707	707	707
								RF	602	602	602
74-76	B3904 [1 Lato]	75,8-77,8	69,6	96	114	25	1	TR	529	529	529
								AS	715	715	715
								RF	609	609	609
76-78	B3905 [1 Lato]	77,8-79,8	71,6	99	117	26	1	TR	533	533	533
								AS	720	720	720
								RF	613	613	613
78-80	B3906 [1 Lato]	79,8-81,8	73,6	102	118	28	1	TR	542	542	542
								AS	732	732	732
								RF	624	624	624
80-82	B3907 [1 Lato]	81,8-83,8	75,6	105	121	29	1	TR	545	545	545
								AS	736	736	736
								RF	627	627	627
82-84	B3908 [1 Lato]	83,8-85,8	77,6	108	124	30	1	TR	550	550	550
								AS	743	743	743
								RF	633	633	633
84-86	B3910 [1 Lato]	85,8-87,8	79,6	110	144	31	1	TR	558	558	558
								AS	754	754	754
								RF	642	642	642
86-88	B3911 [1 Lato]	87,8-89,8	81,6	113	146	32	1	TR	561	561	561
								AS	758	758	758
								RF	646	646	646
96-98	B3912 [1 Lato]	97,8-99,8	91,6	127	175	38	1	TR	587	587	587
								AS	793	793	793
								RF	676	676	676

Tempi di consegna

1-2 settimane

2-3 settimane

3-4 settimane

N.B. I valori della tabella prezzi si riferiscono ad un singolo lato; sommare l'importo dei due codici con la misura desiderata per ottenere il prezzo totale di un box doccia ad angolo quadrato o rettangolare.

Nota: apertura determinata con due lati della stessa misura. Per il trattamento StarClean considerare un aumento di una settimana dei tempi di consegna.

Nelle finiture L91 e L96 i particolari sono in tinta.

Prodotti Speciali	Misure limite	I [€]	II [€]	III [€]
	H max 217 cm / L max 100 cm - min 50 cm	105	135	155

Modulo di richiesta disponibile on-line sul sito: www.samo.it/it/prodotti-speciali - In caso di annullamento dopo l'accettazione, sarà addebitato il costo totale dell'ordine.

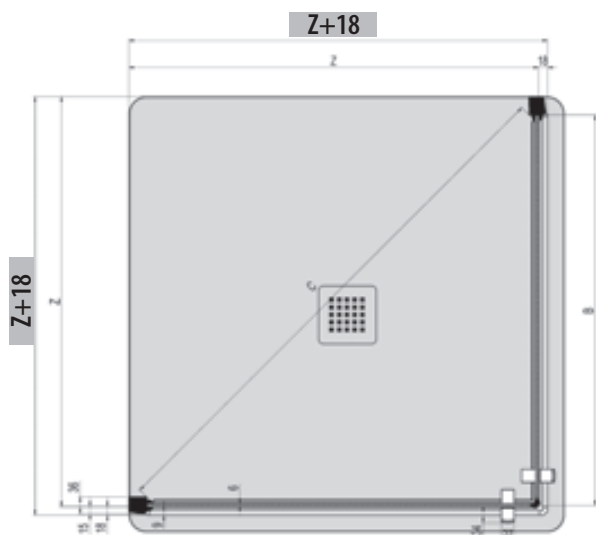

Z1 + 1,3 _ Parete fissa per abbinamenti (pag. 270-1)

Cod.	B3850	B3851	B3852	B3853	B3854	B3855
Estensibilità	65,3-67,8	67,8-70,3	70,3-72,8	72,8-75,3	75,3-77,8	77,8-80,3
Cod.	B3856	B3857	B3858	B3860	B3861	B3862
Estensibilità	80,3-82,8	82,8-85,3	85,3-87,8	87,8-90,3	90,3-92,8	97,8-100,3
Cod.	B3863	B3864	B3865	B3866	B3867	
Estensibilità	100,3-102,8	107,8-110,3	110,3-112,8	117,8-120,3	120,3-122,8	

Nelle misure dell'estensibilità sono compresi gli ingombri degli elementi usati.



Tattamento anticalcare optional da inserire al momento dell'ordine € 50 x 1 lato





Inquadrare il QR code per collegarsi alla pagina del sito www.samo.it per vedere altre combinazioni di pannelli e vetri

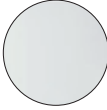
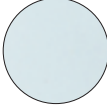
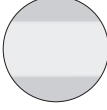

Finitura pannelli

-  TR
Trasparente
-  AS
Satinato Acqua
-  RF
Trasparente con fascia satinata
H 100 cm.

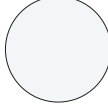

Profili in alluminio

-  ULU
Brillantato cromo
-  L91
Bianco opaco
-  L96
Nero opaco

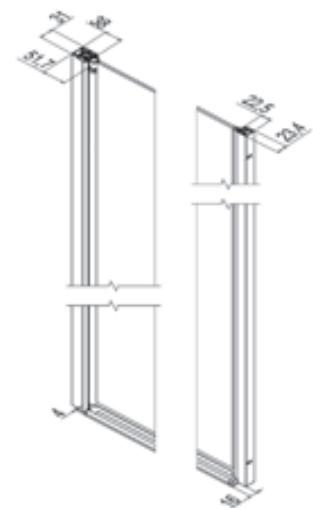
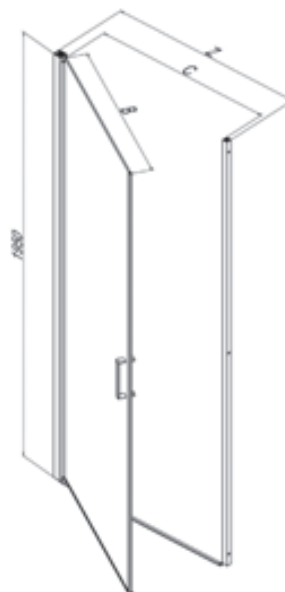
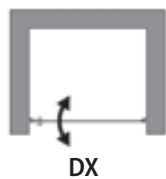
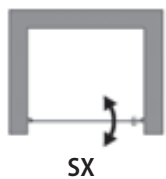
Porta ad un'anta a battente con apertura verso l'interno e verso l'esterno.



Le dimensioni sono espresse in mm.

Z [cm]	Cod.	A [cm]	B [cm]	C [cm]	 [dm ³]	 [kg]	 [n°]	Pannelli	ULU [€]	L91 [€]	L96 [€]
67-70	B3930	//	60,4	59	116	25	1	TR	530	530	530
								AS	716	716	716
								RF	610	610	610
70-73	B3931	//	63,2	62	125	27	1	TR	539	539	539
								AS	728	728	728
								RF	620	620	620
73-76	B3932	//	66,4	65	131	28	1	TR	545	545	545
								AS	736	736	736
								RF	627	627	627
77-80	B3933	//	70,4	69	133	29	1	TR	554	554	554
								AS	748	748	748
								RF	638	638	638
80-83	B3934	//	73,2	72	142	30	1	TR	560	560	560
								AS	756	756	756
								RF	644	644	644
83-86	B3935	//	76,4	75	145	31	1	TR	566	566	566
								AS	765	765	765
								RF	651	651	651
87-90	B3936	//	80,4	79	152	32	1	TR	574	574	574
								AS	775	775	775
								RF	661	661	661
97-100	B3937	//	90,4	89	159	33	1	TR	578	578	578
								AS	781	781	781
								RF	665	665	665

Tempi di consegna

1-2 settimane

2-3 settimane

3-4 settimane

Per il trattamento StarClean considerare un aumento di una settimana dei tempi di consegna.
Nelle finiture L91 e L96 i particolari sono in tinta.

Prodotti Speciali	Misure limite	I [€]	II [€]	III [€]
	H max 217 cm / L max 100 cm - min 50 cm	115	135	150

Modulo di richiesta disponibile on-line sul sito: www.samo.it/it/prodotti-speciali - In caso di annullamento dopo l'accettazione, sarà addebitato il costo totale dell'ordine.

Maniglia optional		L91 - L96 [€]	ULU [€]
H00	da richiedere al momento dell'ordine	36	36

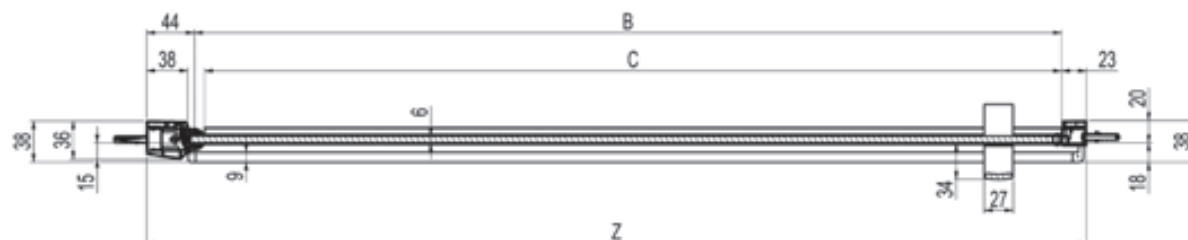

Treatment anticalcare optional da inserire al momento dell'ordine € 50



Inquadrare il QR code per collegarsi alla pagina del sito www.samo.it per vedere altre combinazioni di pannelli e vetri

195
cm

6
mm



Finitura pannelli

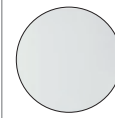

TR
Trasparente

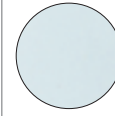

AS
Satinato Acqua

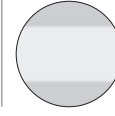

RF
Trasparente con fascia satinata
H 100 cm.

Profili in alluminio



ULU
Brillantato cromo

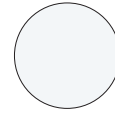

L91
Bianco opaco



L96
Nero opaco

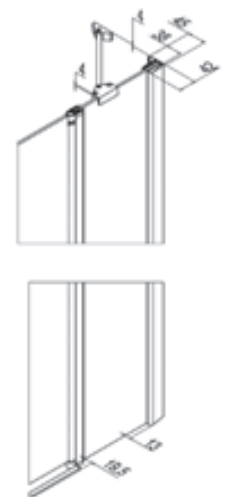
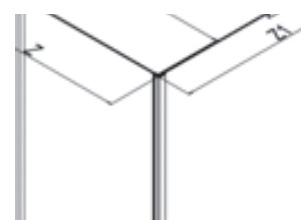
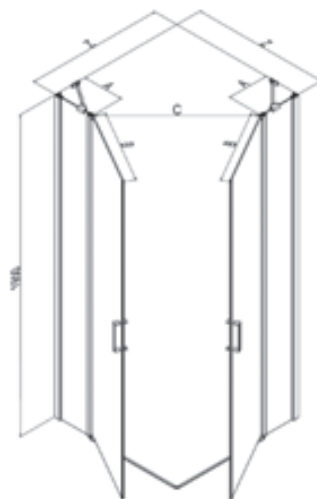
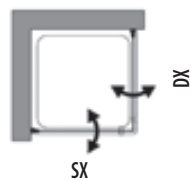

Angolo a quattro ante, due pareti fisse e due battenti apribili verso l'esterno e verso l'interno.



Le dimensioni sono espresse in mm.

Kit abbinamento optional, per abbinamento con la parete fissa, da acquistare separatamente

Cod.	ULU [€]	L91 [€]	L96 [€]
200 cm. KT3800	148	148	148

Estensibilità Z [cm]	Cod.	Max ingombro Z+1,8 [cm]	A [cm]	B [cm]	C [cm]	 [dm³]	 [kg]	 [n°]	Pannelli	ULLU [€]	L91 [€]	L96 [€]
65-67,5	B3800 [1 Lato]	66,8-69,3	23,1	41,4	57	133	27	1	TR	657	657	657
									AS	887	887	887
									RF	756	756	756
67,5-70	B3801 [1 Lato]	69,3-71,8	23,1	43,9	60	136	28	1	TR	659	659	659
									AS	890	890	890
									RF	758	758	758
70,5-73	B3802 [1 Lato]	72,3-74,8	23,1	46,9	65	136	28	1	TR	662	662	662
									AS	894	894	894
									RF	762	762	762
73-75,5	B3803 [1 Lato]	74,8-77,3	25,5	46,9	65	141	29	1	TR	666	666	666
									AS	900	900	900
									RF	766	766	766
76,5-79	B3804 [1 Lato]	78,3-80,8	26,6	49,4	68	143	30	1	TR	669	669	669
									AS	904	904	904
									RF	770	770	770
79-81,5	B3805 [1 Lato]	80,8-83,3	25,5	52,9	73	146	31	1	TR	672	672	672
									AS	908	908	908
									RF	773	773	773
82-84,5	B3806 [1 Lato]	83,8-86,3	28,6	52,9	73	148	31	1	TR	675	675	675
									AS	912	912	912
									RF	777	777	777
85-87,5	B3807 [1 Lato]	86,8-89,3	25,5	58,9	82	156	32	1	TR	679	679	679
									AS	917	917	917
									RF	781	781	781
87,5-90	B3808 [1 Lato]	89,3-91,8	28,1	58,9	82	165	33	1	TR	683	683	683
									AS	923	923	923
									RF	786	786	786
95-97,5	B3810 [1 Lato]	96,8-99,3	30,8	63,6	88	171	35	1	TR	693	693	693
									AS	936	936	936
									RF	797	797	797
97,5-100	B3811 [1 Lato]	99,3-101,8	33,5	63,6	88	175	36	1	TR	696	696	696
									AS	940	940	940
									RF	801	801	801
105-107,5	B3812 [1 Lato]	106,8-109,3	34,7	69,6	97	185	39	1	TR	710	710	710
									AS	959	959	959
									RF	817	817	817
115-117,5	B3813 [1 Lato]	116,8-119,3	45,1	69,6	97	195	42	1	TR	726	726	726
									AS	981	981	981
									RF	835	835	835

Tempi di consegna	1-2 settimane	2-3 settimane	3-4 settimane
-------------------	---------------	---------------	---------------

N.B. I valori della tabella prezzi si riferiscono ad un singolo lato: sommare l'importo dei due codici con la misura desiderata per ottenere il prezzo totale di un box doccia ad angolo quadrato o rettangolare.
Nota: apertura determinata con due lati della stessa misura. Per il trattamento StarClean considerare un aumento di una settimana dei tempi di consegna.
Nelle finiture L91 e L96 i particolari sono in tinta.

Prodotti Speciali	Misure limite	I [€]	II [€]	III [€]
		H max 217 cm / L max 120 cm - min 65 cm	105	135

Modulo di richiesta disponibile on-line sul sito: www.samo.it/it/prodotti-speciali - In caso di annullamento dopo l'accettazione, sarà addebitato il costo totale dell'ordine.

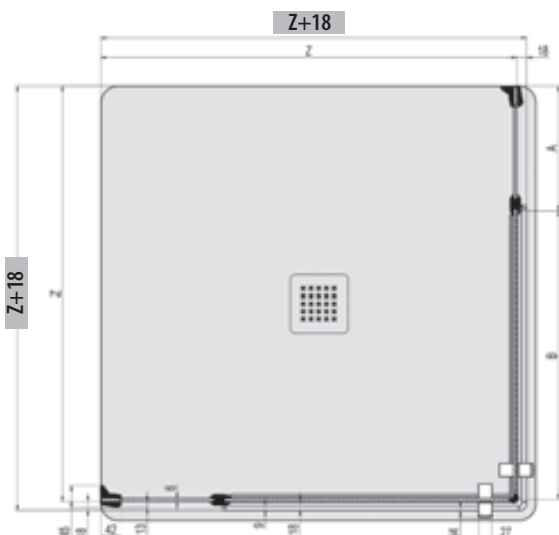

Z1 + 1,3 _ Parete fissa per abbinamenti (pag. 270-1)						
Cod.	B3850	B3851	B3852	B3853	B3854	B3855
Estensibilità	65,3-67,8	67,8-70,3	70,3-72,8	72,8-75,3	75,3-77,8	77,8-80,3
Cod.	B3856	B3857	B3858	B3860	B3861	B3862
Estensibilità	80,3-82,8	82,8-85,3	85,3-87,8	87,8-90,3	90,3-92,8	97,8-100,3
Cod.	B3863	B3864	B3865	B3866	B3867	
Estensibilità	100,3-102,8	107,8-110,3	110,3-112,8	117,8-120,3	120,3-122,8	

Nelle misure dell'estensibilità sono compresi gli ingombri degli elementi usati.



Treatmento anticalcare optional da inserire al momento dell'ordine € 50 x 1 lato



Inquadrare il QR code per collegarsi alla pagina del sito www.samo.it per vedere altre combinazioni di pannelli e vetri

Polaris



-  195
cm
-  6
mm
- 
- 
- 
- 
- 
- 
- 
- 
- 
- 
- 

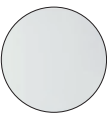
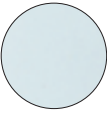
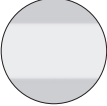

Finitura pannelli

-  TR
Trasparente
-  AS
Satinato Acqua
-  RF
Trasparente con fascia satinata
H 100 cm.

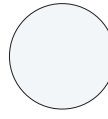

Profili in alluminio

-  ULU
Brillantato cromo
-  L91
Bianco opaco
-  L96
Nero opaco

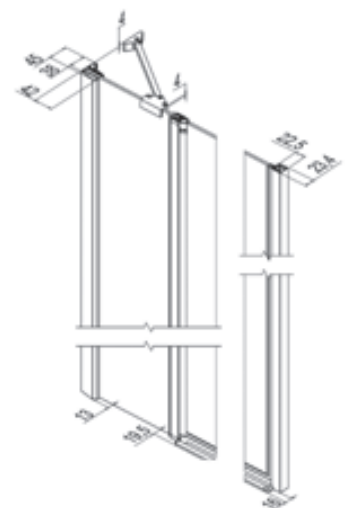
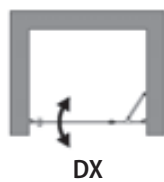
Porta ad un'anta a battente con apertura verso l'interno e verso l'esterno.



Le dimensioni sono espresse in mm.

Z [cm]	Cod.	A [cm]	B [cm]	C [cm]	 [dm³]	 [kg]	 [n°]	Pannelli	ULU [€]	L91 [€]	L96 [€]
65,5-69	B3831	22,1	41,1	40	133	26	1	TR	688	688	688
								AS	929	929	929
								RF	792	792	792
69-72,5	B3832	23,1	43,6	42	136	28	1	TR	691	691	691
								AS	933	933	933
								RF	795	795	795
72,5-76	B3833	23,6	46,6	45	139	28	1	TR	696	696	696
								AS	940	940	940
								RF	801	801	801
76-79,5	B3834	24,6	49,1	48	142	30	1	TR	701	701	701
								AS	947	947	947
								RF	807	807	807
79,5-83	B3835	24,6	52,6	51	145	32	1	TR	706	706	706
								AS	954	954	954
								RF	812	812	812
83-86,5	B3836	25,5	55,1	54	148	33	1	TR	711	711	711
								AS	960	960	960
								RF	818	818	818
86,5-90	B3837	25,5	58,6	57	150	35	1	TR	718	718	718
								AS	970	970	970
								RF	826	826	826
90-93,5	B3838	29,1	58,6	57	152	36	1	TR	727	727	727
								AS	982	982	982
								RF	837	837	837
93,5-97	B3840	32,6	58,6	57	157	36	1	TR	735	735	735
								AS	993	993	993
								RF	846	846	846
97-100,5	B3841	31,2	63,3	62	160	38	1	TR	746	746	746
								AS	1008	1008	1008
								RF	858	858	858
100,5-104	B3842	34,7	63,3	62	163	38	1	TR	751	751	751
								AS	1014	1014	1014
								RF	864	864	864
104-107,5	B3843	36,4	65,3	64	166	38	1	TR	758	758	758
								AS	1024	1024	1024
								RF	872	872	872
107,5-111	B3844	35,8	69,3	68	175	39	1	TR	766	766	766
								AS	1035	1035	1035
								RF	881	881	881
111-114,5	B3845	39,3	69,3	68	180	41	1	TR	769	769	769
								AS	1039	1039	1039
								RF	885	885	885
114,5-118	B3846	40,8	71,3	70	193	41	1	TR	771	771	771
								AS	1041	1041	1041
								RF	887	887	887
118-121,5	B3847	42,3	73,3	72	195	42	1	TR	776	776	776
								AS	1048	1048	1048
								RF	893	893	893

Tempi di consegna

1-2 settimane

2-3 settimane

3-4 settimane

Per il trattamento StarClean considerare un aumento di una settimana dei tempi di consegna.
Nelle finiture L91 e L96 i particolari sono in tinta.

Prodotti Speciali	Misure limite	I [€]	II [€]	III [€]
	H max 217 cm / L max 140 cm - min 60 cm	115	155	185

Modulo di richiesta disponibile on-line sul sito: www.samo.it/it/prodotti-speciali - In caso di annullamento dopo l'accettazione, sarà addebitato il costo totale dell'ordine.



Tattamento anticalcare optional da inserire al momento dell'ordine € 50



Inquadrare il QR code per collegarsi alla pagina del sito
www.samo.it per vedere altre combinazioni di pannelli e vetri

195
cm

6
mm



Finitura pannelli

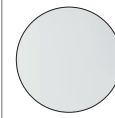

TR
Trasparente

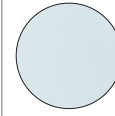

AS
Satinato Acqua

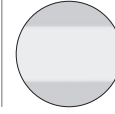

RF
Trasparente con fascia satinata
H 100 cm.

Profili in alluminio



ULU
Brillantato cromo

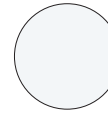

L91
Bianco opaco



L96
Nero opaco

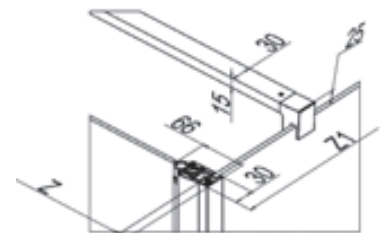

Z+14

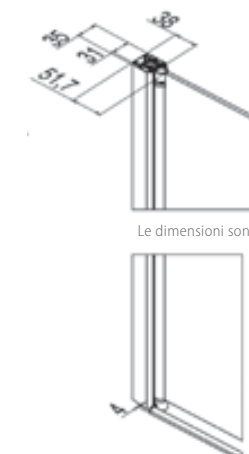

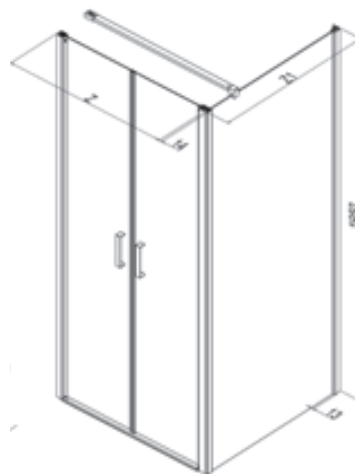

Le dimensioni sono espresse in mm.

Porta a saloon, apertura ad ante battenti verso l'interno e verso l'esterno.



Kit di sostegno obbligatorio, per abbinamento con la parete fissa, da acquistare separatamente

Cod.	ULU [€]	L91 [€]	L96 [€]
140 cm. KT3920	135	135	135

Z [cm]	Cod.	Max ingombro Z+1,4 [cm]	B [cm]	C [cm]	 [dm³]	 [kg]	 [n°]	Pannelli	ULU [€]	L91 [€]	L96 [€]
64-68	B3920	65,4-69,4	27,8	53	70	26	1	TR	778	778	778
								AS	1051	1051	1051
								RF	895	895	895
68-72	B3921	69,4-73,4	29,8	57	75	27	1	TR	786	786	786
								AS	1062	1062	1062
								RF	904	904	904
72-76	B3922	73,4-77,4	31,8	61	77	28	1	TR	794	794	794
								AS	1072	1072	1072
								RF	914	914	914
76-80	B3923	77,4-81,4	33,8	65	79	28	1	TR	804	804	804
								AS	1086	1086	1086
								RF	925	925	925
80-84	B3924	81,4-85,4	35,8	69	79	29	1	TR	815	815	815
								AS	1101	1101	1101
								RF	938	938	938
84-88	B3925	85,4-89,4	37,8	73	81	30	1	TR	823	823	823
								AS	1112	1112	1112
								RF	947	947	947
88-92	B3926	89,4-93,4	39,8	77	84	31	1	TR	832	832	832
								AS	1124	1124	1124
								RF	957	957	957
92-96	B3927	93,4-97,4	41,8	81	93	33	1	TR	840	840	840
								AS	1134	1134	1134
								RF	966	966	966
96-100	B3928	97,4-101,4	43,8	85	100	35	1	TR	848	848	848
								AS	1145	1145	1145
								RF	976	976	976
Tempi di consegna					1-2 settimane		2-3 settimane		3-4 settimane		

Per il trattamento StarClean considerare un aumento di una settimana dei tempi di consegna.
Nelle finiture L91 e L96 i particolari sono in tinta.

Prodotti Speciali	Misure limite	I [€]	II [€]	III [€]
	H max 217 cm / L max 140 cm - min 60 cm	170	190	230

Modulo di richiesta disponibile on-line sul sito: www.samo.it/it/prodotti-speciali - In caso di annullamento dopo l'accettazione, sarà addebitato il costo totale dell'ordine.

Maniglia optional		L91 - L96 [€]	ULU [€]
H00	da richiedere al momento dell'ordine	36	36

Z1 + 1,3 _ Parete fissa per abbinamenti (pag. 270-1)

Cod.	B3850	B3851	B3852	B3853	B3854	B3855	B3856	B3857	B3858	B3860	B3861	B3862	B3863	B3864	B3865	B3866	B3867
Estensibilità	65,8-68,3	68,3-70,8	70,8-73,8	73,8-75,8	75,8-78,3	78,3-80,8	80,8-83,3	83,3-85,8	85,8-88,3	88,3-90,8	90,8-93,3	93,3-100,8	100,8-103,3	103,3-110,8	110,8-113,3	113,3-120,8	120,8-123,3



Tattamento anticalcare optional da inserire al momento dell'ordine € 50



Inquadrare il QR code per collegarsi alla pagina del sito
www.samo.it per vedere altre combinazioni di pannelli e vetri



-  195 cm
-  6 mm
- 
- 
- 
- 
- 
- 
- 
- 
- 
- 
- 
- 

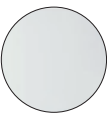
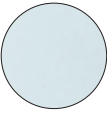
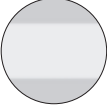

Finitura pannelli

-  TR
Trasparente
-  AS
Satinato Acqua
-  RF
Trasparente con fascia satinata H 100 cm.

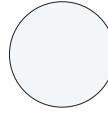
Profili in alluminio

-  ULU
Brillantato cromo
-  L91
Bianco opaco
-  L96
Nero opaco

Porta ad un'anta a battente, una parete fissa e una battente apribile verso l'interno e l'esterno.



SX



DX

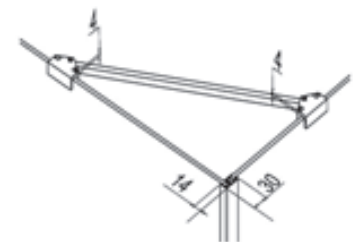
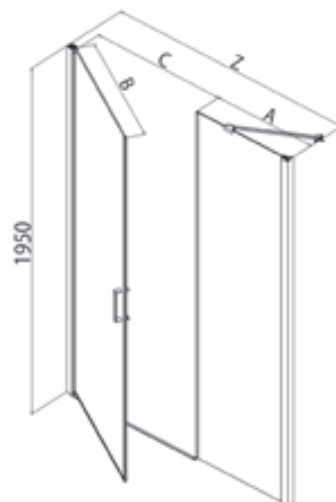

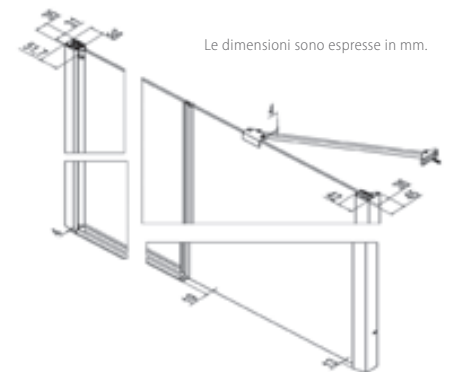

Le dimensioni sono espresse in mm.



Kit di sostegno optional, per abbinamento con la parete fissa, da acquistare separatamente, per gli articoli B3986, B3987, B3988 e B3990 se ne consiglia l'utilizzo.

Cod.	ULU [€]	L91 [€]	L96 [€]
200 cm. KT3800	148	148	148

Z [cm]	Cod.	Max ingombro Z+1,3 [cm]	A [cm]	B [cm]	C [cm]	 [dm³]	 [kg]	 [n°]	Pannelli	ULU [€]	L91 [€]	L96 [€]
97-101	B3980	98,3-101,7	34,2	58,4	57	116	38	1	TR	802	802	802
									AS	1083	1083	1083
									RF	923	923	923
101-105	B3981	102,3-105,7	38,1	58,4	57	116	38	1	TR	820	820	820
									AS	1107	1107	1107
									RF	943	943	943
107-111	B3982	108,3-111,7	41,4	61,1	60	122	39	1	TR	837	837	837
									AS	1130	1130	1130
									RF	963	963	963
111-115	B3983	112,3-115,7	41,4	65,1	64	130	41	1	TR	857	857	857
									AS	1157	1157	1157
									RF	986	986	986
117-121	B3984	118,3-121,7	43,5	69,1	68	138	42	1	TR	857	857	857
									AS	1157	1157	1157
									RF	986	986	986
121-125	B3985	122,3-125,7	43,5	73,1	72	146	45	1	TR	874	874	874
									AS	1180	1180	1180
									RF	1006	1006	1006
137-141	B3986	138,3-141,7	57,5	75,1	74	150	49	1	TR	909	909	909
									AS	1228	1228	1228
									RF	1046	1046	1046
157-161	B3987	158,3-161,7	73,4	79,1	78	158	52	2	TR	950	950	950
									AS	1283	1283	1283
									RF	1093	1093	1093
167-171	B3988	168,3-171,7	72,3	90,3	89	180	60	2	TR	976	976	976
									AS	1318	1318	1318
									RF	1123	1123	1123
177-181	B3990	178,3-181,7	82,3	90,3	89	180	65	2	TR	1003	1003	1003
									AS	1355	1355	1355
									RF	1154	1154	1154

Tempi di consegna	1-2 settimane	2-3 settimane	3-4 settimane
-------------------	---------------	---------------	---------------

Per il trattamento StarClean considerare un aumento di una settimana dei tempi di consegna.
Nelle finiture L91 e L96 i particolari sono in tinta.

Prodotti Speciali	Misure limite	I [€]	II [€]	III [€]
	H max 217 cm / L max 180 cm - min 60 cm	135	155	185

Modulo di richiesta disponibile on-line sul sito: www.samo.it/it/prodotti-speciali - In caso di annullamento dopo l'accettazione, sarà addebitato il costo totale dell'ordine.

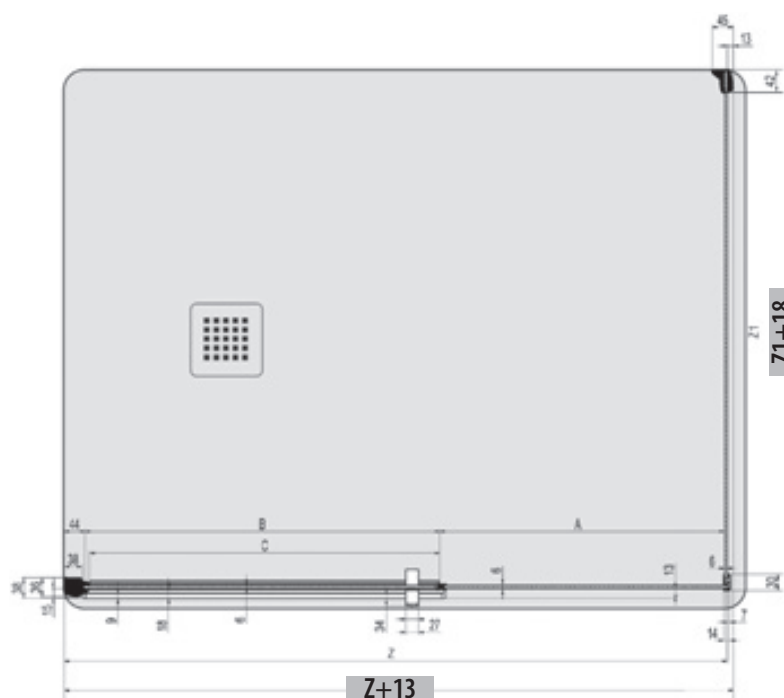

Le dimensioni sono espresse in mm.

Z1 + 1,8 _ Parete fissa per abbinamenti (pag. 270-1)

Cod.	B3850	B3851	B3852	B3853	B3854
Estensibilità	65,8-68,3	68,3-70,8	70,8-73,8	73,8-75,8	75,8-78,3
Cod.	B3855	B3856	B3857	B3858	B3860
Estensibilità	78,3-80,8	80,8-83,3	83,3-85,8	85,8-88,3	88,3-90,8
Cod.	B3861	B3862	B3863	B3864	B3865
Estensibilità	90,8-93,3	98,3-100,8	100,8-103,3	108,3-110,8	110,8-113,3
Cod.	B3866	B3867			
Estensibilità	118,3-120,8	120,8-123,3			



Tattamento anticalcare optional da inserire al momento dell'ordine € 50





Inquadrare il QR code per collegarsi alla pagina del sito www.samo.it per vedere altre combinazioni di pannelli e vetri

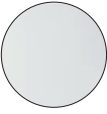
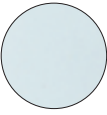
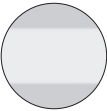

Finitura pannelli

-  TR
Trasparente
-  AS
Satinato Acqua
-  RF
Trasparente con fascia satinata
H 100 cm.

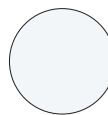
Profili in alluminio

-  ULU
Brillantato cromo
-  L91
Bianco opaco
-  L96
Nero opaco

Porta battente, due pareti fisse e un'anta battente verso l'interno e verso l'esterno.

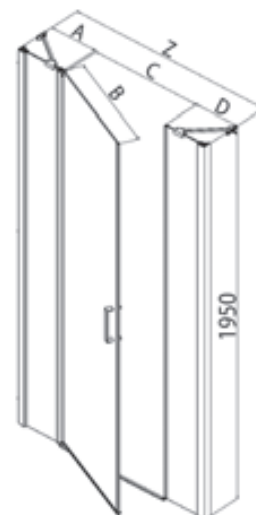
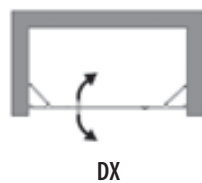
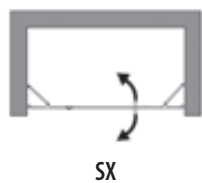

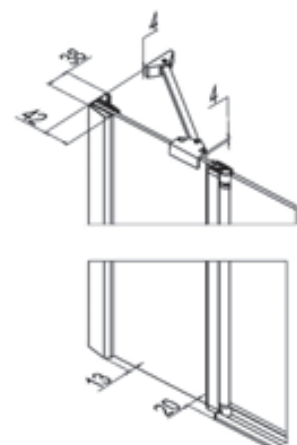

Le dimensioni sono espresse in mm.



Kit di sostegno optional, per abbinamento con la parete fissa, da acquistare separatamente, per gli articoli B3888, B3889, B3890, B3891, B3892, B3893 e B3994 se ne consiglia l'utilizzo.

Cod.	ULU [€]	L91 [€]	L96 [€]
200 cm. KT3800	148	148	148

Z [cm]	Cod.	Max ingombro Z+1,3 [cm]	A [cm]	B [cm]	C [cm]	D [cm]	 [dm³]	 [kg]	 [n°]	Pannelli	ULU [€]	L91 [€]	L96 [€]
97-102	B3880	98,3-100,8	23,1	52,5	51	21,5	138	38	1	TR	1066	1066	1066
										AS	1440	1440	1440
										RF	1226	1226	1226
102-107	B3881	103,3-105,8	25,5	52,5	51	23,9	132	38	1	TR	1073	1073	1073
										AS	1449	1449	1449
										RF	1234	1234	1234
107-112	B3882	108,3-110,8	25	58,5	57	23,4	142	39	1	TR	1079	1079	1079
										AS	1457	1457	1457
										RF	1241	1241	1241
11-117	B3883	113,3-115,8	27,5	58,5	57	25,9	146	41	1	TR	1085	1085	1085
										AS	1465	1465	1465
										RF	1248	1248	1248
117-122	B3884	118,3-120,8	28,6	61,2	60	27	152	43	1	TR	1091	1091	1091
										AS	1473	1473	1473
										RF	1255	1255	1255
122-127	B3885	123,3-125,8	30,2	63,2	62	28,6	158	45	1	TR	1098	1098	1098
										AS	1483	1483	1483
										RF	1263	1263	1263
127-132	B3886	128,3-130,8	32,6	63,2	62	31	162	46	1	TR	1105	1105	1105
										AS	1492	1492	1492
										RF	1271	1271	1271
132-137	B3887	133,3-135,8	32,2	69,2	68	30,6	172	47	1	TR	1111	1111	1111
										AS	1500	1500	1500
										RF	1278	1278	1278
137-142	B3888	138,3-140,8	32,6	73,2	72	31	179	49	1	TR	1119	1119	1119
										AS	1511	1511	1511
										RF	1287	1287	1287
142-147	B3890	143,3-145,8	35,2	73,2	72	33,6	184	51	1	TR	1126	1126	1126
										AS	1521	1521	1521
										RF	1295	1295	1295
147-152	B3891	148,3-150,8	37,6	73,2	72	36	188	52	2	TR	1132	1132	1132
										AS	1529	1529	1529
										RF	1302	1302	1302
157-162	B3892	158,3-160,8	41,6	75,2	74	40	198	54	2	TR	1158	1158	1158
										AS	1564	1564	1564
										RF	1332	1332	1332
167-172	B3893	168,3-170,8	44,7	79,2	78	43,1	210	60	2	TR	1185	1185	1185
										AS	1600	1600	1600
										RF	1363	1363	1363
177-182	B3894	178,3-180,8	46,3	86	85	44,7	225	64	2	TR	1211	1211	1211
										AS	1635	1635	1635
										RF	1393	1393	1393

Tempi di consegna

1-2 settimane

2-3 settimane

3-4 settimane

Per il trattamento StarClean considerare un aumento di una settimana dei tempi di consegna. Nelle finiture L91 e L96 i particolari sono in tinta.

Prodotti Speciali	Misure limite	I [€]	II [€]	III [€]
	H max 217 cm / L max 200 cm - min 97 cm	200	215	250

Modulo di richiesta disponibile on-line sul sito: www.samo.it/it/prodotti-speciali - In caso di annullamento dopo l'accettazione, sarà addebitato il costo totale dell'ordine.

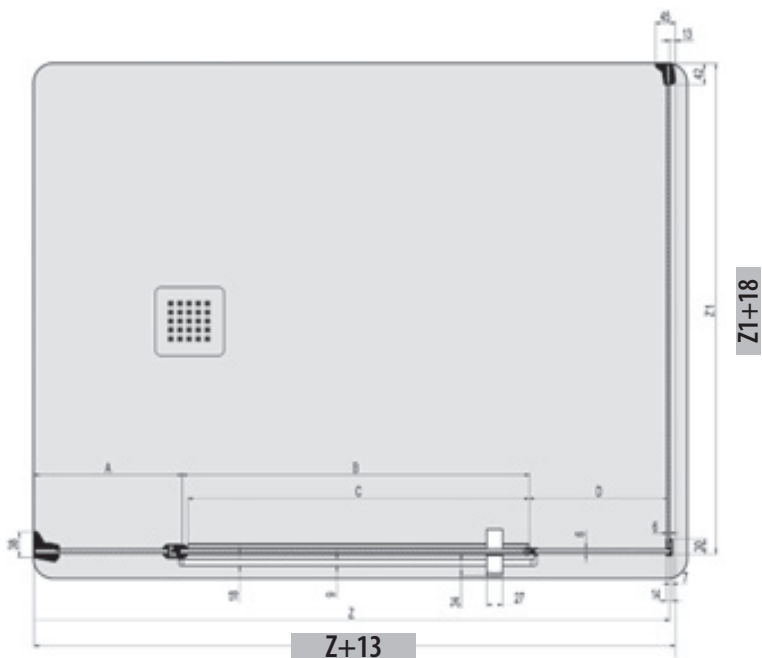

Z1 + 1,8 _ Parete fissa per abbinamenti (pag. 270-1)					
Cod.	B3850	B3851	B3852	B3853	B3854
Estensibilità	65,8-68,3	68,3-70,8	70,8-73,8	73,8-75,8	75,8-78,3
Cod.	B3855	B3856	B3857	B3858	B3860
Estensibilità	78,3-80,8	80,8-83,3	83,3-85,8	85,8-88,3	88,3-90,8
Cod.	B3861	B3862	B3863	B3864	B3865
Estensibilità	90,8-93,3	98,3-100,8	100,8-103,3	108,3-110,8	110,8-113,3
Cod.	B3866	B3867			
Estensibilità	118,3-120,8	120,8-123,3			



Tattamento anticalcare optional da inserire al momento dell'ordine € 100



Inquadrare il QR code per collegarsi alla pagina del sito www.samo.it per vedere altre combinazioni di pannelli e vetri



-  195
cm
-  6
mm
- 
- 
- 
- 
- 
- 
- 
- 
- 

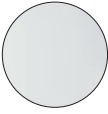
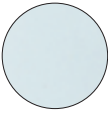
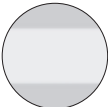

Finitura pannelli

-  TR
Trasparente
-  AS
Satinato Acqua
-  RF
Trasparente con fascia satinata
H 100 cm.

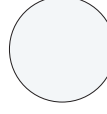

Profili in alluminio

-  ULU
Brillantato cromo
-  L91
Bianco opaco
-  L96
Nero opaco

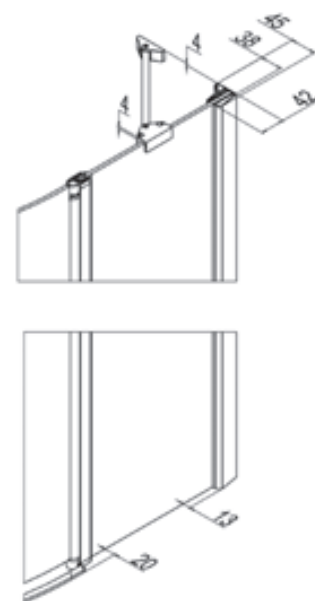
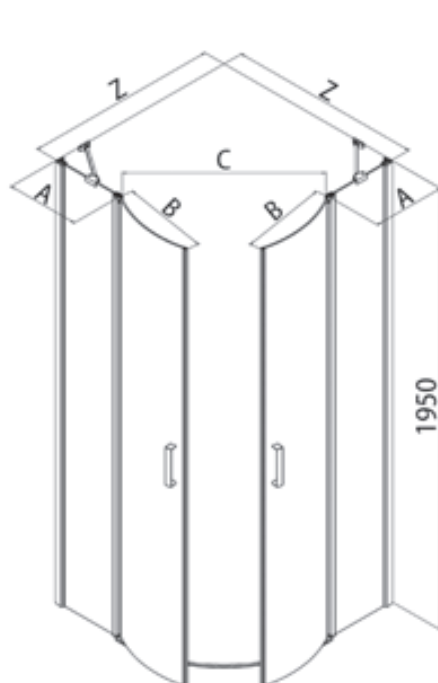
Tondo a quattro ante, due fisse laterali e due apribili frontali verso l'interno e verso l'esterno.



Le dimensioni sono espresse in mm.

Z [cm]	Cod.	Max ingombro Z+1,8 [cm]	A [cm]	B [cm]	C [cm]	 [dm ³]	 [kg]	 [n°]	Pannelli	ULU [€]	L91 [€]	L96 [€]
75,5-78	B3873	77,3-79,8	22,1	40,6	73	266	50	2	TR	1455	1455	1455
									AS	1965	1965	1965
									RF	1674	1674	1674
85,5-88	B3872	87,3-89,8	32,1	40,6	73	300	50	2	TR	1498	1498	1498
									AS	2023	2023	2023
									RF	1723	1723	1723
95,5-98	B3874	97,3-99,8	42,1	40,6	73	320	52	2	TR	1544	1544	1544
									AS	2085	2085	2085
									RF	1776	1776	1776

Tempi di consegna

1-2 settimane

2-3 settimane

3-4 settimane

Per estensibilità si intende la misura dal muro al lato esterno del pannello in vetro.
Adatto a piatti doccia arrotondati a raggio NON costante, raggio curvatura = 55 cm.
Abbinamento con parete fissa NON possibile.

Per il trattamento StarClean considerare un aumento di una settimana dei tempi di consegna.
Nelle finiture L91 e L96 i particolari sono in tinta.

Prodotti Speciali	Misure limite	I [€]	II [€]	III [€]
	H max 195 cm / L max 120 cm - min 75,5 cm	250	//	400

Modulo di richiesta disponibile on-line sul sito: www.samo.it/it/prodotti-speciali - In caso di annullamento dopo l'accettazione, sarà addebitato il costo totale dell'ordine.

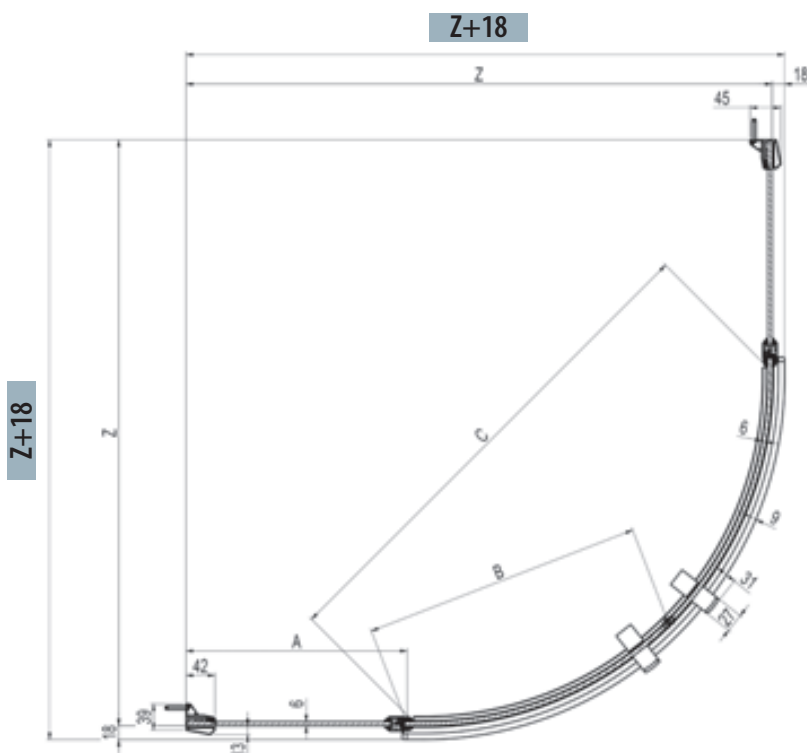

Tattamento anticalcare optional da inserire al momento dell'ordine € 100



Inquadrare il QR code per collegarsi alla pagina del sito www.samo.it per vedere altre combinazioni di pannelli e vetri



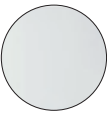
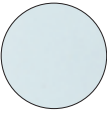
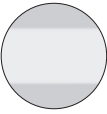

-  195 cm
-  6 mm
- 
- 
- 
- 
- 

Finitura pannelli

-  TR
Trasparente
-  AS
Satinato Acqua
-  RF
Trasparente con fascia satinata H 100 cm.

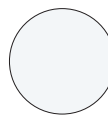
Profili in alluminio

-  ULU
Brillantato cromo
-  L91
Bianco opaco
-  L96
Nero opaco

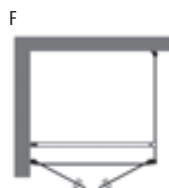
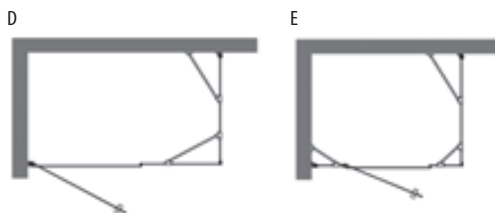
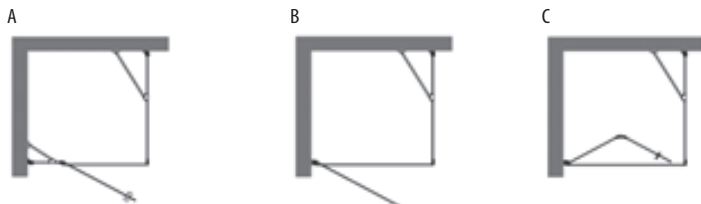

Parete fissa per abbinamenti, è possibile formare cabine doccia a due o tre lati, anche misure rettangolari. La zanca di fissaggio a muro è di serie e compresa nel prezzo.

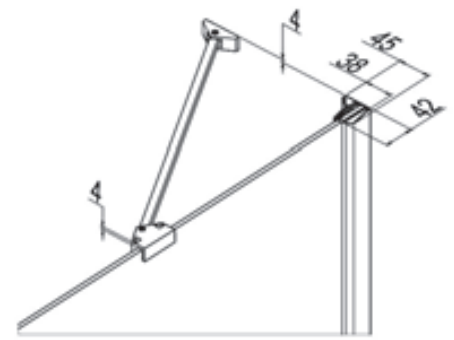
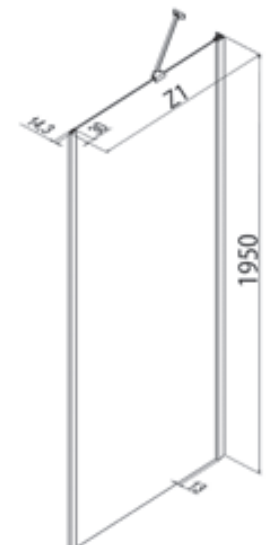
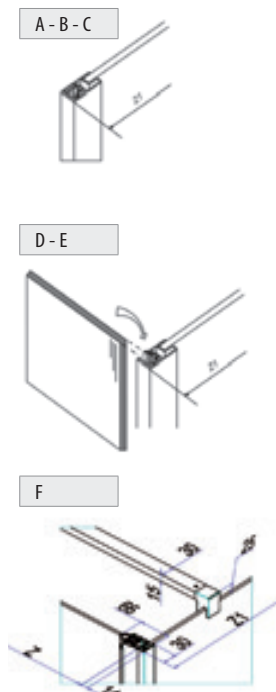

Possibili combinazioni



Le dimensioni sono espresse in mm.

Z1 [cm]	Cod.	A [cm]	B [cm]	C [cm]	 [dm ³]	 [kg]	 [n°]	Pannelli	ULU [€]	L91 [€]	L96 [€]
64-66,5	B3850	//	//	//	99	29	1	TR	484	484	484
								AS	654	654	654
								RF	557	557	557
66,5-69	B3851	//	//	//	101	29	1	TR	488	488	488
								AS	659	659	659
								RF	562	562	562
69-71,5	B3852	//	//	//	102	29	1	TR	491	491	491
								AS	663	663	663
								RF	565	565	565
71,5-74	B3853	//	//	//	112	29	1	TR	495	495	495
								AS	669	669	669
								RF	570	570	570
74-76,5	B3854	//	//	//	115	30	1	TR	497	497	497
								AS	671	671	671
								RF	572	572	572
76,5-79	B3855	//	//	//	117	31	1	TR	500	500	500
								AS	675	675	675
								RF	575	575	575
79-81,5	B3856	//	//	//	120	34	1	TR	504	504	504
								AS	681	681	681
								RF	580	580	580
81,5-84	B3857	//	//	//	137	35	1	TR	508	508	508
								AS	686	686	686
								RF	585	585	585
84-86,5	B3858	//	//	//	140	35	1	TR	513	513	513
								AS	693	693	693
								RF	590	590	590
86,5-89	B3860	//	//	//	143	35	1	TR	521	521	521
								AS	704	704	704
								RF	600	600	600
89-91,5	B3861	//	//	//	144	36	1	TR	524	524	524
								AS	708	708	708
								RF	603	603	603
96,5-99	B3862	//	//	//	156	37	1	TR	544	544	544
								AS	735	735	735
								RF	626	626	626
99-101,5	B3863	//	//	//	160	38	1	TR	561	561	561
								AS	758	758	758
								RF	646	646	646
106,5-109	B3864	//	//	//	162	39	1	TR	578	578	578
								AS	781	781	781
								RF	665	665	665
109-111,5	B3865	//	//	//	165	40	1	TR	597	597	597
								AS	806	806	806
								RF	687	687	687
116,5-119	B3866	//	//	//	168	41	1	TR	618	618	618
								AS	835	835	835
								RF	711	711	711
119-121,5	B3867	//	//	//	170	42	1	TR	637	637	637
								AS	860	860	860
								RF	733	733	733

Tempi di consegna

1-2 settimane

2-3 settimane

3-4 settimane

Per il trattamento StarClean considerare un aumento di una settimana dei tempi di consegna.

Polaris

Prodotti Speciali	Misure limite	I [€]	II [€]	III [€]
Parete fissa	H max 217 cm / L max 130 cm - min 50 cm	110	120	150

Modulo di richiesta disponibile on-line sul sito: www.samo.it/it/prodotti-speciali - In caso di annullamento dopo l'accettazione, sarà addebitato il costo totale dell'ordine.



Tattamento anticalcare optional da inserire al momento dell'ordine € 50



Inquadrare il QR code per collegarsi alla pagina del sito www.samo.it per vedere altre combinazioni di pannelli e vetri

195
cm

6
mm



Finitura pannelli

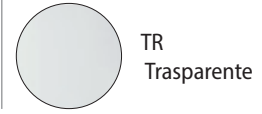

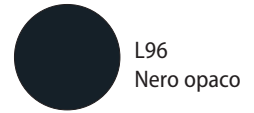
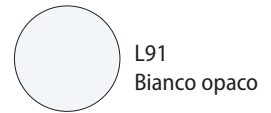

Profili in alluminio

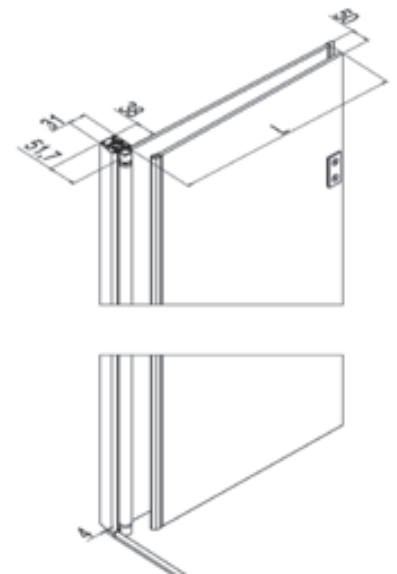
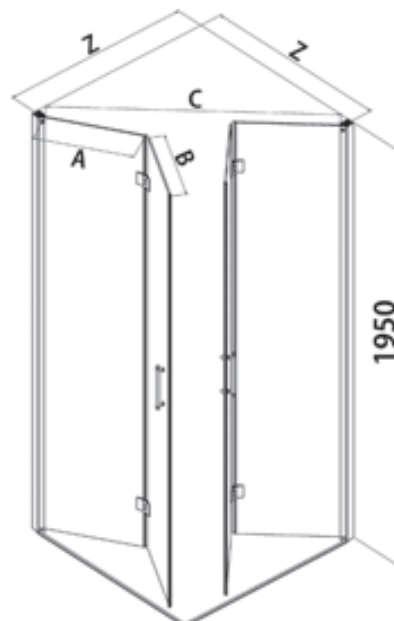
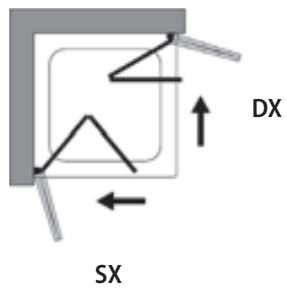

Angolo con due ante a soffietto ripiegabili sia all'interno che all'esterno.



Le dimensioni sono espresse in mm.

Estensibilità Z [cm]	Cod.	Max ingombro Z+1,1 [cm]	A [cm]	B [cm]	C [cm]	L [cm]	 [dm³]	 [kg]	 [n°]	Pannelli	L91-L96 [€]	ULU [€]
66-68	B9520 <small>[1 Lato]</small>	67,1-69,1	30,6	29,8	75	30,6	102	24	1	TR	637	637
68-70	B9521 <small>[1 Lato]</small>	69,1-71,1	31,6	30,8	78	31,6	106	24	1	TR	642	642
70-72	B9522 <small>[1 Lato]</small>	71,1-73,1	32,6	31,8	81	32,6	108	24	1	TR	648	648
72-74	B9523 <small>[1 Lato]</small>	73,1-75,1	33,6	32,8	84	33,6	110	24	1	TR	654	654
74-76	B9524 <small>[1 Lato]</small>	75,1-77,1	34,6	33,8	87	34,6	115	25	1	TR	666	666
76-78	B9525 <small>[1 Lato]</small>	77,1-79,1	35,6	34,8	90	35,6	118	26	1	TR	673	673
78-80	B9526 <small>[1 Lato]</small>	79,1-81,1	36,6	35,8	93	36,6	121	28	1	TR	683	683
80-82	B9527 <small>[1 Lato]</small>	81,1-83,1	37,6	36,8	96	37,6	122	29	1	TR	690	690
82-84	B9528 <small>[1 Lato]</small>	83,1-85,1	38,6	37,8	99	38,6	125	30	1	TR	698	698
84-86	B9529 <small>[1 Lato]</small>	85,1-87,1	39,6	38,8	102	39,6	126	31	1	TR	705	705
86-88	B9530 <small>[1 Lato]</small>	87,1-89,1	40,6	39,8	105	40,6	127	32	1	TR	715	715
88-90	B9531 <small>[1 Lato]</small>	89,1-91,1	41,6	40,8	108	41,6	131	33	1	TR	721	721
90-92	B9532 <small>[1 Lato]</small>	91,1-93,1	42,6	41,8	111	42,6	133	34	1	TR	729	729
92-94	B9533 <small>[1 Lato]</small>	93,1-95,1	43,6	42,8	114	43,6	136	35	1	TR	738	738
94-96	B9534 <small>[1 Lato]</small>	95,1-97,1	44,6	43,8	117	44,6	139	37	1	TR	745	745
96-98	B9535 <small>[1 Lato]</small>	97,1-99,1	45,6	44,8	120	45,6	142	38	1	TR	753	753
98-100	B9536 <small>[1 Lato]</small>	99,1-101,1	46,6	45,8	123	46,6	144	39	1	TR	761	761

Tempi di consegna

1-2 settimane

2-3 settimane

3-4 settimane

I valori della tabella prezzi si riferiscono ad un singolo lato: sommare l'importo dei due codici con la misura desiderata per ottenere il prezzo di un box doccia ad angolo quadrato o rettangolare. Per il trattamento StarClean considerare un aumento di una settimana dei tempi di consegna. Nelle finiture L91 e L96 i particolari sono in tinta.

Prodotti Speciali	Misure limite	I [€]	II [€]	III [€]
	H max 217 cm / L max 110 cm - min 60 cm	135	170	200

Modulo di richiesta disponibile on-line sul sito: www.samo.it/it/prodotti-speciali - In caso di annullamento dopo l'accettazione, sarà addebitato il costo totale dell'ordine.

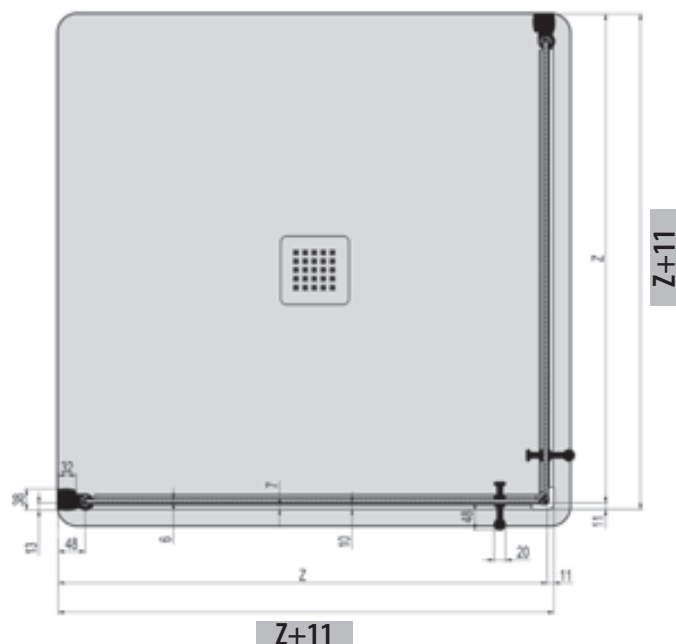

Parete fissa per abbinamenti (pag. 270-1)

Cod.	B3850	B3851	B3852	B3853	B3854	B3855
	64-66,5	66,5-69	69-71,5	71,5-74	74-76,5	76,5-79
Cod.	B3856	B3857	B3858	B3860	B3861	B3862
	79-81,5	81,5-84	84-86,5	86,5-89	89-91,5	96,5-99
Cod.	B3863	B3864	B3865	B3866	B3867	
	99-101,5	106,5-109	109-111,5	116,5-119	119-121,5	



Trattamento anticalcare optional da inserire al momento dell'ordine € 50



Inquadrare il QR code per collegarsi alla pagina del sito www.samo.it per vedere altre combinazioni di pannelli e vetri



Finitura pannelli

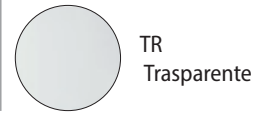

Profili in alluminio

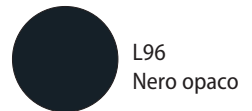

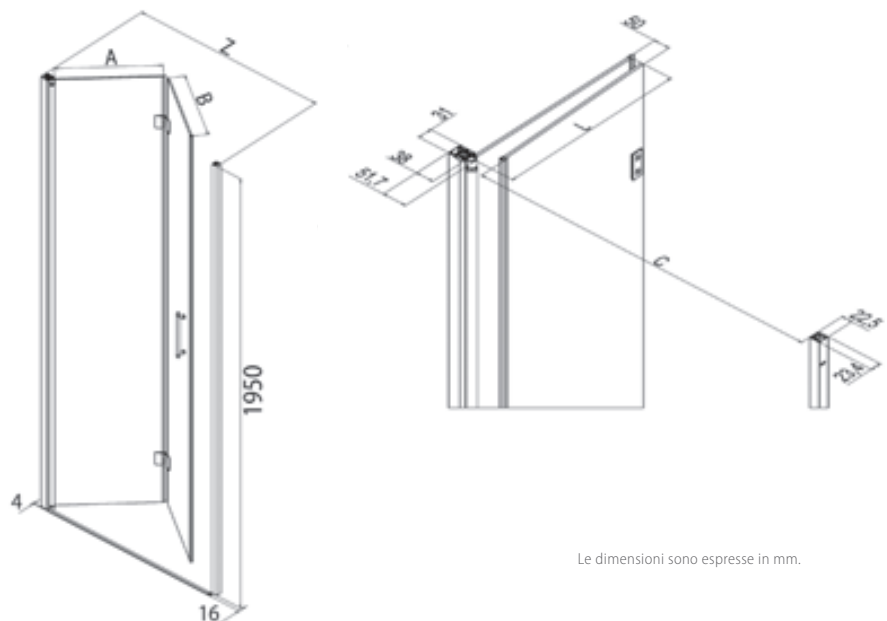
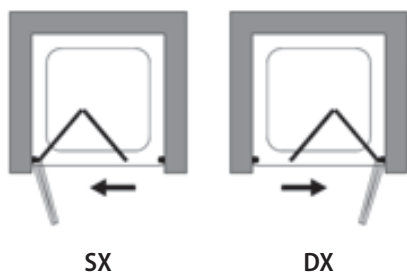

Cabina doccia a due ante con apertura a soffietto.

Installazione solo in nicchia, non è possibile abbinare la porta alla parete fissa per formare un angolo.



Le dimensioni sono espresse in mm.

Estensibilità Z [cm]	Cod.	A [cm]	B [cm]	C [cm]	L [cm]	 [dm ³]	 [kg]	 [n°]	Pannelli	L91-L96 [€]	ULU [€]
66-69	B9541	29,6	28,3	54	29,6	63	25	1	TR	788	788
69,5-72,5	B9542	31,6	29,8	58	31,6	66	27	1	TR	797	797
73-76	B9543	33,6	31,3	61	33,6	68	28	1	TR	808	808
76,5-79,5	B9544	35,6	32,8	65	35,6	70	29	1	TR	818	818
80-83	B9545	36,6	35,3	68	36,6	73	30	1	TR	826	826
83,5-86,5	B9546	38,6	36,8	72	38,6	76	31	1	TR	835	835
87-90	B9547	40,6	38,3	75	40,6	79	32	1	TR	842	842
90,5-93,5	B9548	42,6	39,8	79	42,6	80	33	1	TR	852	852

Tempi di consegna

1-2 settimane

2-3 settimane

3-4 settimane

I valori della tabella prezzi si riferiscono ad un singolo lato: sommare l'importo dei due codici con la misura desiderata per ottenere il prezzo di un box doccia ad angolo quadrato o rettangolare. Per il trattamento StarClean considerare un aumento di una settimana dei tempi di consegna. Nelle finiture L91 e L96 i particolari sono in tinta.

Prodotti Speciali	Misure limite	I [€]	II [€]	III [€]
	H max 217 cm / L max 110 cm - min 60 cm	170	200	230

Modulo di richiesta disponibile on-line sul sito: www.samo.it/it/prodotti-speciali - In caso di annullamento dopo l'accettazione, sarà addebitato il costo totale dell'ordine.

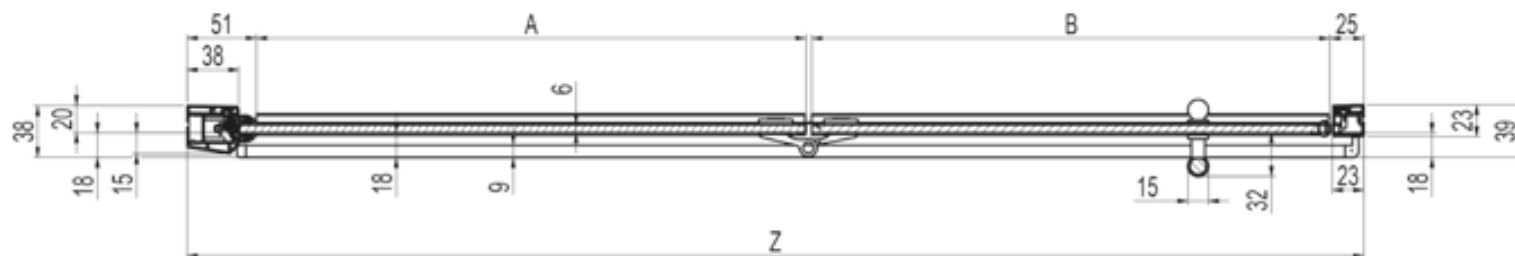

Tattamento anticalcare optional da inserire al momento dell'ordine € 50



Inquadrare il QR code per collegarsi alla pagina del sito www.samo.it per vedere altre combinazioni di pannelli e vetri

190
cm

6
mm



Finitura pannelli

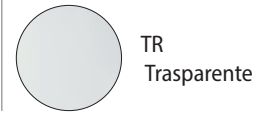

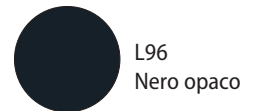
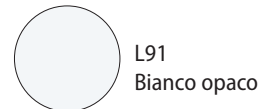

Profili in alluminio

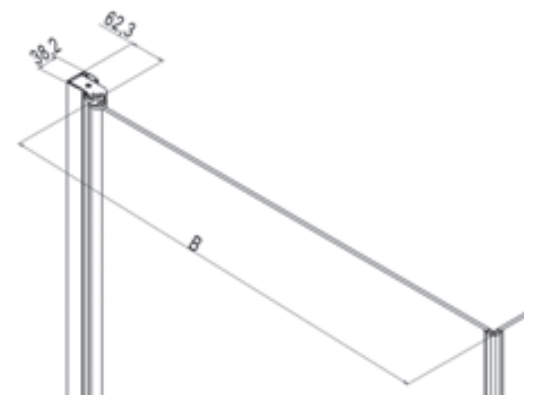
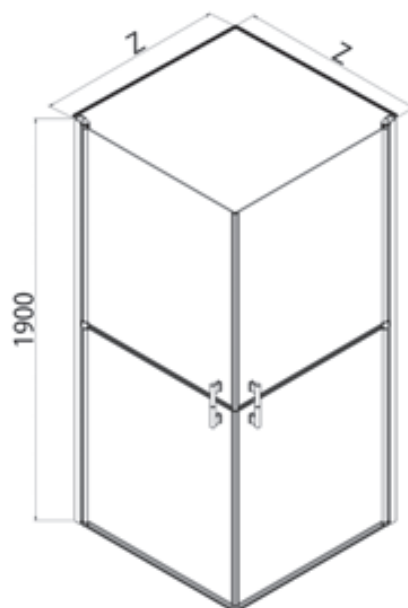

Angolo con ante a battente apribili verso l'interno e verso l'esterno, divisibili in due metà per una migliore gestione della persona all'interno.



Le dimensioni sono espresse in mm.

Estensibilità Z [cm]	Cod.	Max ingombro Z+1,1 [cm]	B [cm]	C [cm]	D [cm]	 [dm³]	 [kg]	 [n°]	Pannelli	L91-L96 [€]	ULU [€]
66-68	B9501 <small>[1 Lato]</small>	67,1-69,1	60	84	6-8	108	24	1	TR	839	839
68-70	B9502 <small>[1 Lato]</small>	69,1-71,1	62	87	6-8	109	24	1	TR	843	843
70-72	B9503 <small>[1 Lato]</small>	71,1-73,1	64	89	6-8	112	24	1	TR	848	848
72-74	B9504 <small>[1 Lato]</small>	73,1-75,1	66	92	6-8	115	24	1	TR	855	855
74-76	B9505 <small>[1 Lato]</small>	75,1-77,1	68	95	6-8	122	25	1	TR	859	859
76-78	B9506 <small>[1 Lato]</small>	77,1-79,1	70	98	6-8	125	26	1	TR	864	864
78-80	B9507 <small>[1 Lato]</small>	79,1-81,1	72	101	6-8	128	28	1	TR	868	868
80-82	B9508 <small>[1 Lato]</small>	81,1-83,1	74	103	6-8	134	29	1	TR	873	873
82-84	B9509 <small>[1 Lato]</small>	83,1-85,1	76	106	6-8	134	30	1	TR	878	878
84-86	B9510 <small>[1 Lato]</small>	85,1-87,1	78	109	6-8	137	31	1	TR	884	884
86-88	B9511 <small>[1 Lato]</small>	87,1-89,1	80	112	6-8	140	32	1	TR	888	888
88-90	B9512 <small>[1 Lato]</small>	89,1-91,1	82	115	6-8	143	33	1	TR	893	893
90-92	B9513 <small>[1 Lato]</small>	91,1-93,1	84	118	6-8	146	34	1	TR	899	899
92-94	B9514 <small>[1 Lato]</small>	93,1-95,1	86	120	6-8	149	35	1	TR	902	902
94-96	B9515 <small>[1 Lato]</small>	95,1-97,1	88	123	6-8	152	37	1	TR	907	907
96-98	B9516 <small>[1 Lato]</small>	97,1-99,1	90	126	6-8	155	38	1	TR	912	912
98-100	B9517 <small>[1 Lato]</small>	99,1-101,1	92	128	6-8	158	39	1	TR	917	917

Tempi di consegna

1-2 settimane

2-3 settimane

3-4 settimane

I valori della tabella prezzi si riferiscono ad un singolo lato: sommare l'importo dei due codici con la misura desiderata per ottenere il prezzo di un box doccia ad angolo quadrato o rettangolare. Per il trattamento StarClean considerare un aumento di una settimana dei tempi di consegna. Nelle finiture L91 e L96 i particolari sono in tinta.

Prodotti Speciali	Misure limite	I [€]	II [€]	III [€]
	H max 217 cm / L max 110 cm - min 60 cm	135	170	200

Modulo di richiesta disponibile on-line sul sito: www.samo.it/it/prodotti-speciali - In caso di annullamento dopo l'accettazione, sarà addebitato il costo totale dell'ordine.

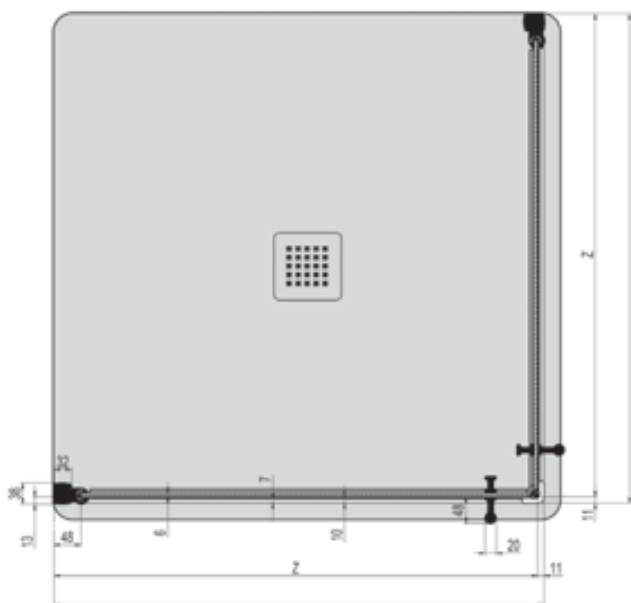

Z+11



Trattamento anticalcare optional da inserire al momento dell'ordine € 50



Inquadrare il QR code per collegarsi alla pagina del sito www.samo.it per vedere altre combinazioni di pannelli e vetri

Flex



Finitura pannelli in vetro

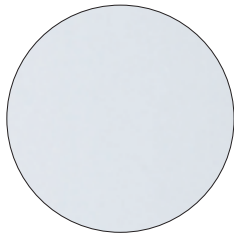

TR
Trasparente

Finitura pannelli in polystyrene



SE
Setola

Profili in alluminio

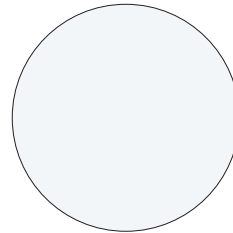

L01
Bianco

Angolo



p. 280



p. 281

Penisola

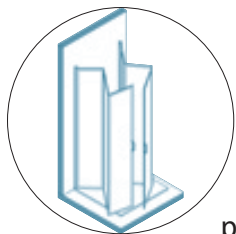

p. 282

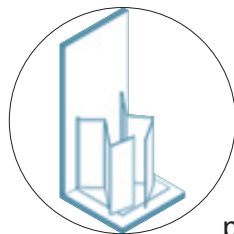

p. 283

Porta

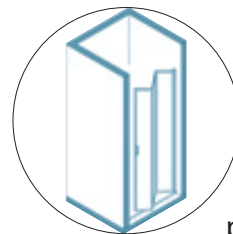

p. 284

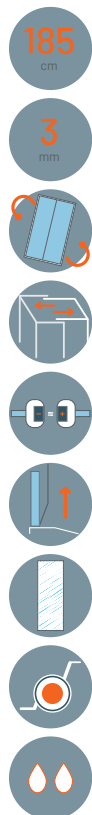

Finitura pannelli in vetro



TR Trasparente

Finitura pannelli in polystirene



SE Setola

Profili in alluminio

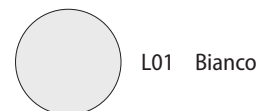

L01 Bianco

Angolo a due lati con antine a soffietto ripiegabili sia all'interno che all'esterno con snodi a 180°.
Soluzioni dedicate a target particolari, ad esempio per anziani e portatori di handicap.

Z [cm]	Cod.	A [cm]	B [cm]	B1 [cm]	D [cm]	E [cm]	F [cm]	G [cm]	H [cm]	[dm³]	[kg]	[n°]	Pannelli	L01 [€]
64-68	B3522	19	18	6,8-10,8	19,5	9,5-13,5	9,5-13,5	21	22,5	94	28	1	TR	729
											22	1	SE	717
68-72	B3523	21,5	18,5	6,8-10,8	20,5	9,5-13,5	9,5-13,5	23,5	25	101	29	1	TR	741
											22	1	SE	726
72-76	B3524	22	20	6,8-10,8	22	9,5-13,5	9,5-13,5	24	25,5	103	30	1	TR	751
											22	1	SE	737
76-80	B3525	23,5	21,5	6,8-10,8	23,5	9,5-13,5	9,5-13,5	25,5	27	109	32	1	TR	764
											23	1	SE	750
80-84	B3526	25,5	22,5	6,8-10,8	24,5	9,5-13,5	9,5-13,5	27,5	29	114	33	1	TR	777
											23	1	SE	762
84-88	B3527	26,5	24	6,8-10,8	26	9,5-13,5	9,5-13,5	28,5	30	120	34	1	TR	788
											24	1	SE	774
88-92	B3528	27,5	25,5	6,8-10,8	27,5	9,5-13,5	9,5-13,5	29,5	31	126	35	1	TR	800
											25	1	SE	786
68-72/88-92	B3543	21,5/27,5	18,5/25,5	6,8-10,8	20,5/27,5	9,5-13,5	9,5-13,5	23,5/29,5	25/31	126	37	1	TR	772
72-76/88-92	B3544	22/27,5	20/25,5	6,8-10,8	22/27,5	9,5-13,5	9,5-13,5	24/29,5	25,5/31	126	26	1	SE	757
											38	1	TR	777
											26	1	SE	763

Prodotti Speciali: si veda pagina 285

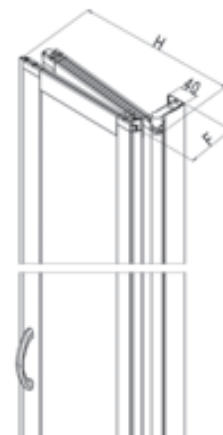
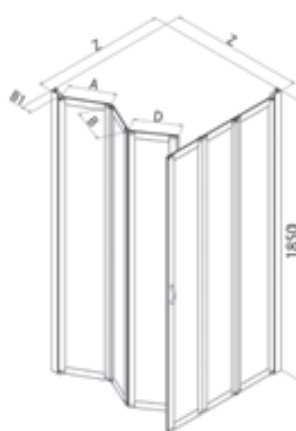
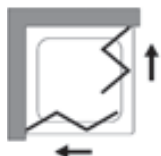

Inquadrare il QR code per collegarsi alla pagina del sito www.samo.it
per vedere altre combinazioni di pannelli e vetri

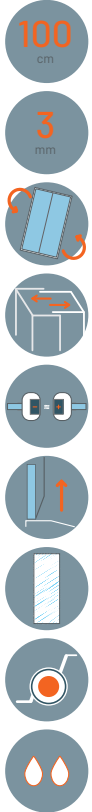

Finitura pannelli in polystirene

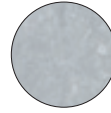

SE Setola

Profili in alluminio

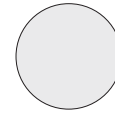

L01 Bianco

Angolo a due lati con ante a soffietto ripiegabili sia all'interno che all'esterno con snodi a 180°. Soluzioni dedicate a target particolari, ad esempio per anziani e portatori di handicap.

Z [cm]	Cod.	A [cm]	B [cm]	B1 [cm]	D [cm]	E [cm]	F [cm]	G [cm]	H [cm]	[dm³]	[kg]	[n°]	Pannelli	L01 [€]
76-80	B3625	23,5	21,5	6,8-10,8	23,5	9,5-13,5	9,5-13,5	25,5	27	51	12	1	SE	476
88-92	B3628	27,5	25,5	6,8-10,8	27,5	9,5-13,5	9,5-13,5	29,5	31	59	14	1	SE	490
Tempi di consegna					1-2 settimane			2-3 settimane			3-4 settimane			

Prodotti Speciali: si veda pagina 285

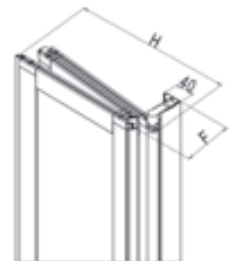
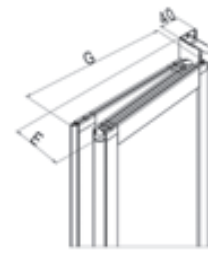
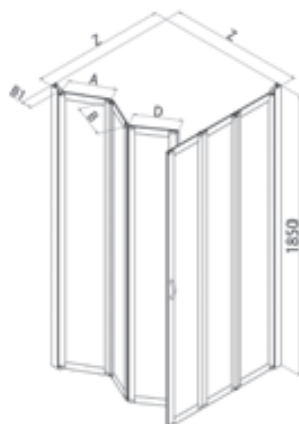
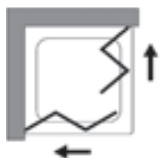

Inquadrare il QR code per collegarsi alla pagina del sito www.samo.it per vedere altre combinazioni di pannelli e vetri

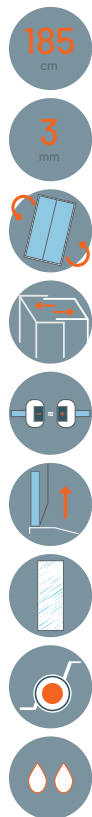

Penisola a tre lati con ante a soffietto ripiegabili sia all'interno che all'esterno con snodi a 180°. Soluzioni dedicate a target particolari, ad esempio per anziani e portatori di handicap.

Finitura pannelli in vetro



Finitura pannelli in polystyrene



Profili in alluminio

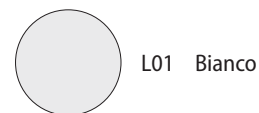

Z [cm]	Cod.	A [cm]	B [cm]	B1 [cm]	C [cm]	D [cm]	E [cm]	F [cm]	G [cm]	H [cm]	[dm ³]	[kg]	[n°]	Pannelli	L01 [€]
63-67	B3532	29	26,5	6,8-10,8	65	31	10-14	9,5-13,5	33	34,5	127	39	1	TR	868
														SE	812
67-71	B3533	30,5	28,5	6,8-10,8	70	33,5	10-14	9,5-13,5	35,5	37	137	40	1	TR	885
														SE	829
71-75	B3534	33	30	6,8-10,8	75	36	10-14	9,5-13,5	38	39,5	144	41	1	TR	900
														SE	844
75-79	B3535	34,5	32,5	6,8-10,8	77	37	10-14	9,5-13,5	39	40,5	150	42	1	TR	917
														SE	861
79-83	B3536	36,5	34,5	6,8-10,8	80	38,5	10-14	9,5-13,5	40,5	42	161	43	1	TR	932
														SE	878
83-87	B3537	38,5	36,5	6,8-10,8	85	41	10-14	9,5-13,5	43	44,5	165	44	1	TR	949
														SE	894
87-91	B3538	40,5	38,5	6,8-10,8	90	43,5	10-14	9,5-13,5	45,5	47	174	45	1	TR	970
														SE	908

Prodotti Speciali: si veda pagina 285

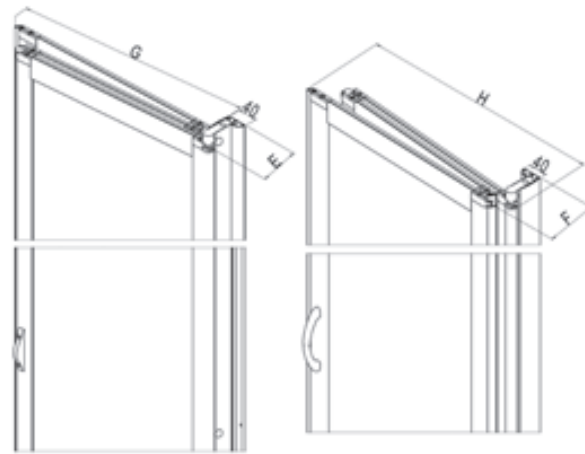

Inquadrare il QR code per collegarsi alla pagina del sito www.samo.it per vedere altre combinazioni di pannelli e vetri

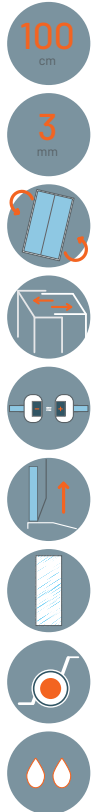

Finitura pannelli in polystyrene



SE Setola

Profili in alluminio

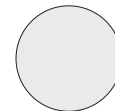

L01 Bianco

Penisola a tre lati con ante a soffietto ripiegabili sia all'interno che all'esterno con snodi a 180°. Soluzioni dedicate a target particolari, ad esempio per anziani e portatori di handicap.

Z [cm]	Cod.	A [cm]	B [cm]	B1 [cm]	C [cm]	D [cm]	E [cm]	F [cm]	G [cm]	H [cm]	[dm³]	[kg]	[n°]	Pannelli	L01 [€]
79-83	B3636	36,5	34,5	6,8-10,8	80	38,5	10-14	9,5-13,5	40,5	42	63	15	1	SE	625
87-91	B3638	40,5	38,5	6,8-10,8	90	43,5	10-14	9,5-13,5	45,5	47	70	18	1	SE	641
Tempi di consegna							1-2 settimane			2-3 settimane			3-4 settimane		

Prodotti Speciali: si veda pagina 285

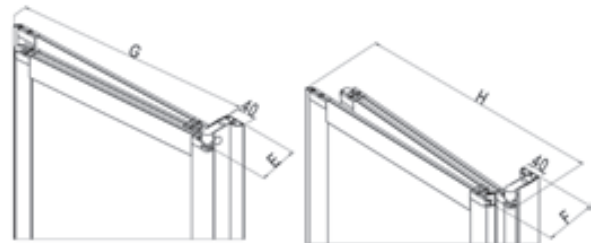
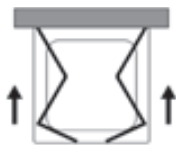

Inquadrare il QR code per collegarsi alla pagina del sito www.samo.it per vedere altre combinazioni di pannelli e vetri

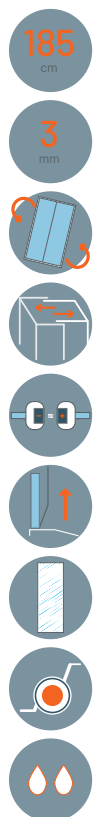

Porta con apertura a soffietto, antine ripiegabili sia all'interno che all'esterno con snodi a 180°. Soluzioni dedicate a target particolari, ad esempio per anziani e portatori di handicap.

Finitura pannelli in vetro



Finitura pannelli in polystirene



Profili in alluminio

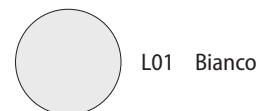

Z [cm]	Cod.	A [cm]	B [cm]	B1 [cm]	C [cm]	D [cm]	E [cm]	F [cm]	G [cm]	H [cm]	[dm³]	[kg]	[n°]	Pannelli	L01 [€]
63-67	B3512	19	17	5-7	4-6	19	9,5-11	10-12	22	23,5	63	17	1	TR	410
														SE	402
67-71	B3513	21	18	5-7	4-6	20	9,5-11	10-12	23	24,5	67	17	1	TR	418
														SE	406
71-75	B3514	21,5	20	5-7	4-6	21,5	9,5-11	10-12	24,5	26	70	18	1	TR	429
														SE	412
75-79	B3515	23	21,5	5-7	4-6	23	9,5-11	10-12	26	27,5	74	19	1	TR	435
														SE	417
79-83	B3516	24,5	22,5	5-7	4-6	24	9,5-11	10-12	27	28,5	78	19	1	TR	443
														SE	423
83-87	B3517	25,5	24	5-7	4-6	25,5	9,5-11	10-12	28,5	30	81	20	1	TR	451
														SE	429
87-91	B3518	27,5	25	5-7	4-6	26,5	9,5-11	10-12	29,5	31	94	20	1	TR	457
														SE	437

Tempi di consegna

1-2 settimane

2-3 settimane

3-4 settimane

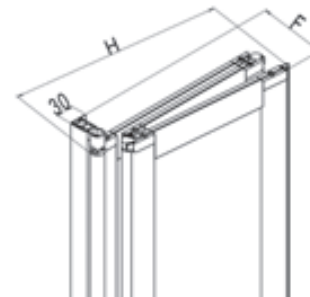
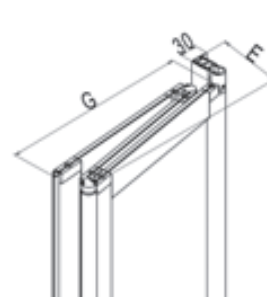
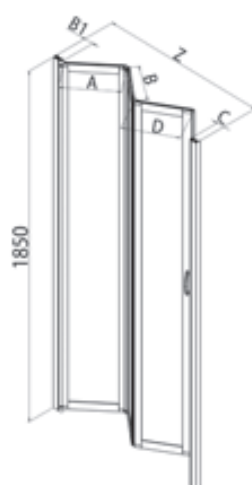

Inquadrare il QR code per collegarsi alla pagina del sito www.samo.it per vedere altre combinazioni di pannelli e vetri

Profili di battuta inferiori a uno, due o tre lati

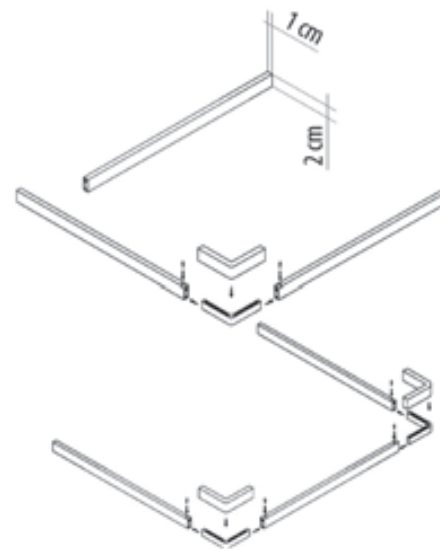

I profili di battuta inferiore sono disponibili a richiesta essendo il box doccia sprovvisto di profili inferiori e superiori. Il profilo viene fornito nella lunghezza massima: al momento dell'installazione tagliare il profilo alla misura desiderata.

Adatti alla versione Flex:
per incasso (art. CO118-CO158),
per angolo a due lati (art. CO128-CO168),
per angolo a tre lati (art. CO138-CO148).

Cod.	Misure Max ingombro [cm]	L01 [€]
CO118	91	36
CO128	92x92	50
CO138	91x91x91	61
CO148	120x120x120	73
CO158	120	47
CO168	120x120	61

Tempi di consegna	1-2 settimane	2-3 settimane	3-4 settimane

Angolo a due lati con ante a soffietto H 185

Prodotti Speciali	Misure limite	I [€]	II [€]	III [€]
Vetro	H max 200 cm - min 100 cm / L max 92 cm - min 46 cm	105	135	155
Polistirene	H max 200 cm - min 100 cm / L max 120 cm - min 46 cm	105	135	155

Angolo a due lati con ante a soffietto H 100

Prodotti Speciali	Misure limite	I [€]	II [€]	III [€]
Polistirene	H max 100 cm / L max 120 cm - min 46 cm	105	135	155

Penisola a tre lati con ante a soffietto H 185

Prodotti Speciali	Misure limite	I [€]	II [€]	III [€]
Vetro	H max 200 cm - min 100 cm / L max 91 cm - min 36 cm	155	175	200
Polistirene	H max 200 cm - min 100 cm / L max 100 cm - min 36 cm	155	175	200

Penisola a tre lati con ante a soffietto H 100

Prodotti Speciali	Misure limite	I [€]	II [€]	III [€]
Polistirene	H max 100 cm / L max 100 cm - min 36 cm	155	175	200

Porta a tre ante ripiegabili a soffietto

Prodotti Speciali	Misure limite	I [€]	II [€]	III [€]
Vetro	H max 200 cm - min 100 cm / L max 109 cm - min 46 cm	90	125	155
Polistirene	H max 200 cm - min 100 cm / L max 120 cm - min 46 cm	90	125	155

"ATTENZIONE: specificare sempre se installazione a filo pavimento o su piatto doccia"



America
quattro SP



America quattro SP



Finitura pannelli

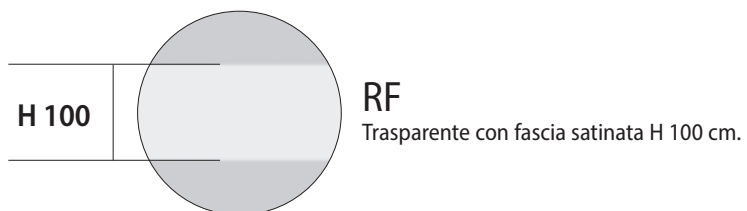
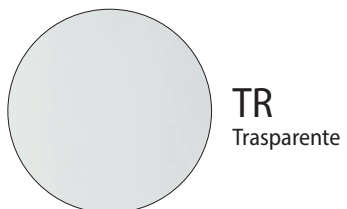

Profili in alluminio

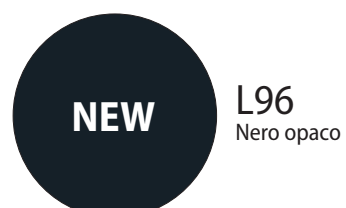
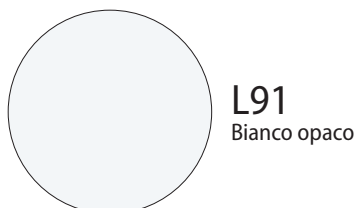

Angolo

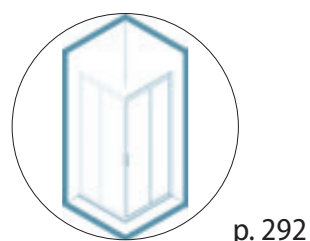
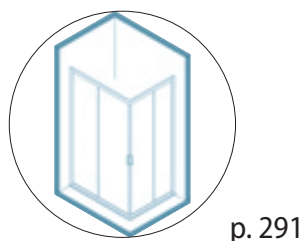
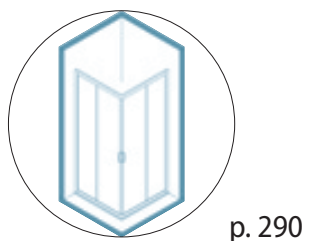

Porta

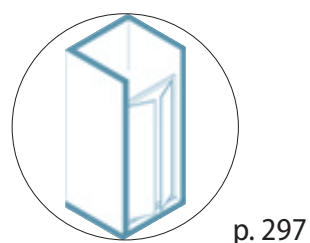
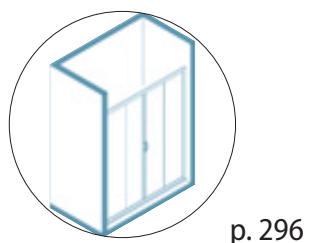
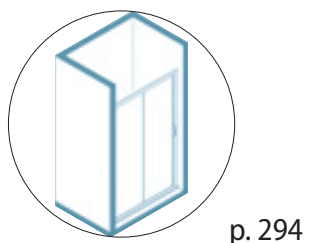

Parete fissa

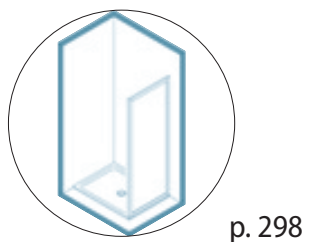

America 4 SP

H 190 cm.
V 4 mm.

Angolo a quattro ante



Finitura pannelli

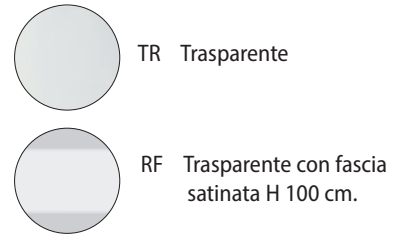

Profili in alluminio



Angolo a quattro ante, apertura ad ante scorrevoli, due fisse e due apribili.

Z [cm]	Cod.	A [cm]	B [cm]	B1 [cm]	C [cm]	D [cm]	[dm ³]	[kg]	[n°]	Pannelli	L91 [€]	L96 [€]	ULU [€]
67-69	B6312	32-34	32,5	//	36	//	170	27	1	TR	690	690	702
										RF	794	794	808
69-71	B6313	33-35	33,5	//	37	//	176	28	1	TR	690	690	702
										RF	794	794	808
73-75	B6314	35-37	35,5	//	40	//	184	30	1	TR	709	709	719
										RF	816	816	827
77-79	B6315	37-39	37,5	//	43	//	197	31	1	TR	729	729	739
										RF	839	839	850
79-81	B6316	38-40	38,5	//	44	//	202	33	1	TR	729	729	739
										RF	839	839	850
83-85	B6317	40-42	40,5	//	47	//	209	34	1	TR	750	750	761
										RF	863	863	876
87-89	B6318	42-44	42,5	//	50	//	218	36	1	TR	768	768	779
										RF	884	884	896
89-91	B6319	43-45	43,5	//	51	//	223	37	1	TR	768	768	779
										RF	884	884	896

Prodotti Speciali: si veda pagina 299

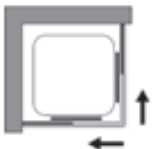

Inquadrare il QR code per collegarsi alla pagina del sito www.samo.it per vedere altre combinazioni di pannelli e vetri

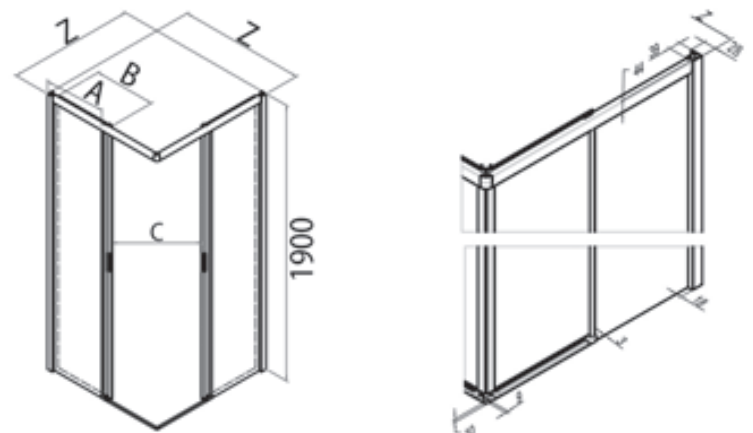

Trattamento anticalcare optional da inserire al momento dell'ordine € 100

America 4 SP

H 190 cm.
V 4 mm.

Rettagonolare a quattro ante



Finitura pannelli

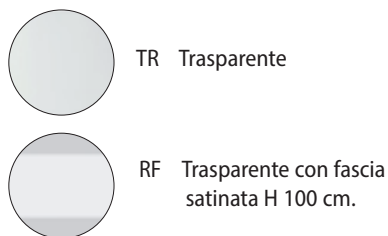

Profili in alluminio



Angolo rettangolare a quattro ante, apertura ad ante scorrevoli, due fisse e due apribili.

Z-Z1 [cm]	Cod.	A [cm]	B [cm]	B1 [cm]	C [cm]	D [cm]	[dm³]	[kg]	[n°]	Pannelli	L91 [€]	L96 [€]	ULU [€]
87-89/67-69	B6372	32-34	32,5	42,5	43	42-44	197	31	1	TR	720	720	734
										RF	828	828	845
89-91/73-75	B6374	35-37	35,5	43,5	45	43-45	202	33	1	TR	740	740	750
										RF	851	851	863
99-101/79-81	B6376	38-40	38,5	48,5	51	48-50	223	37	1	TR	758	758	807
99-101/67-69	B6378	32-34	32,5	48,5	47	48-50	206	34	1	RF	872	872	929
										TR	744	744	765
										RF	856	856	880

Tempi di consegna

1-2 settimane

2-3 settimane

3-4 settimane

Prodotti Speciali: si veda pagina 299

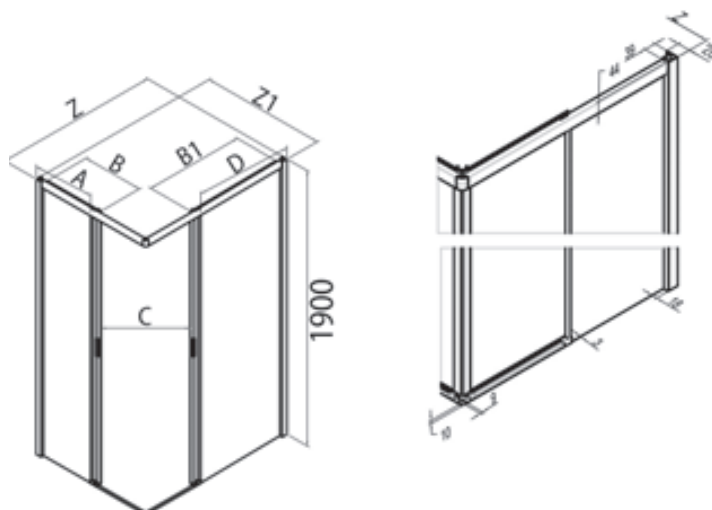
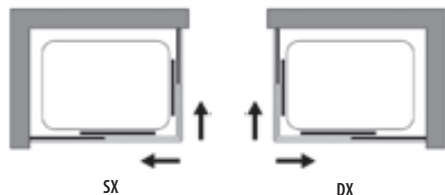

Inquadrare il QR code per collegarsi alla pagina del sito www.samo.it per vedere altre combinazioni di pannelli e vetri



Tattamento anticalcare optional da inserire al momento dell'ordine € 100

America 4 SP



Finitura pannelli

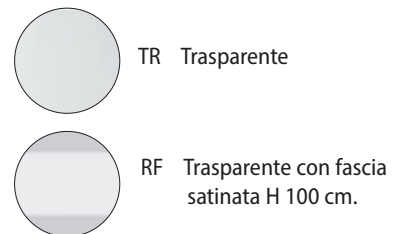



Profili in alluminio

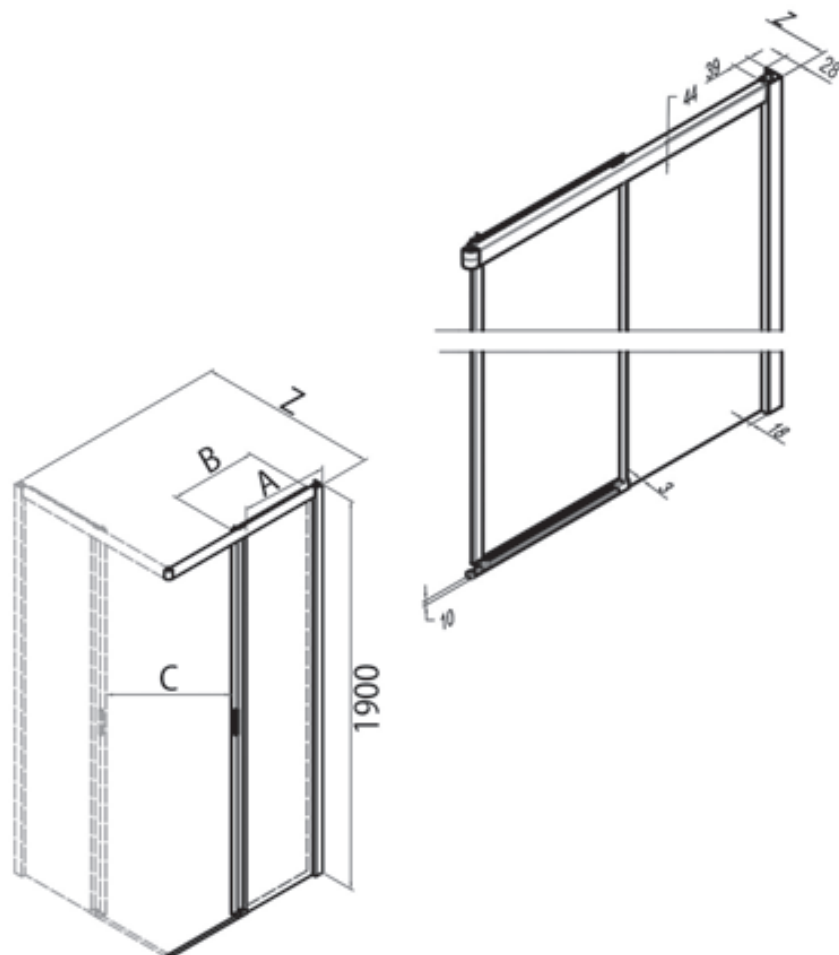
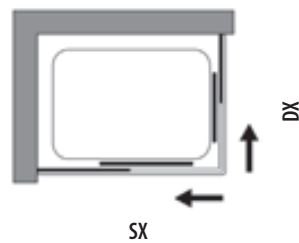
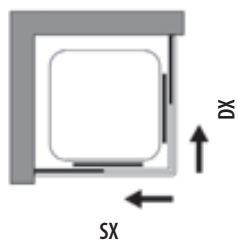

Lato angolo a due ante, apertura ad ante scorrevoli, una fissa e una apribile.



Inquadrare il QR code per collegarsi alla pagina del sito www.samo.it per vedere altre combinazioni di pannelli e vetri

Z [cm]	Cod.	A [cm]	B [cm]	B1 [cm]	C [cm]	D [cm]	 [dm³]	 [kg]	 [n°]	Pannelli	L91 [€]	L96 [€]	ULU [€]
67-69	B6382	32-34	32,5	//	36	//	118	19	1	TR	357	357	371
										RF	411	411	427
69-71	B6383	33-35	33,5	//	37	//	122	20	1	TR	357	357	371
										RF	411	411	427
73-75	B6384	35-37	35,5	//	40	//	128	21	1	TR	367	367	379
										RF	423	423	436
77-79	B6385	37-39	37,5	//	43	//	137	22	1	TR	374	374	389
										RF	431	431	448
79-81	B6386	38-40	38,5	//	44	//	140	23	1	TR	374	374	389
										RF	431	431	448
83-85	B6387	40-42	40,5	//	47	//	145	24	1	TR	382	382	398
										RF	440	440	458
87-89	B6388	42-44	42,5	//	50	//	151	25	1	TR	392	392	412
										RF	451	451	474
89-91	B6389	43-45	43,5	//	51	//	155	26	1	TR	392	392	412
										RF	451	451	474
93-95	B6390	45-47	45,5	//	54	//	160	27	1	TR	392	392	412
										RF	451	451	474
97-99	B6391	47-49	47,5	//	57	//	168	28	1	TR	398	398	426
										RF	458	458	490
99-101	B6392	48-50	48,5	//	58	//	173	29	1	TR	398	398	426
										RF	458	458	490
103-105	B6393	50-52	50,5	//	61	//	179	29	1	TR	400	400	442
										RF	460	460	509
107-109	B6394	54-56	50,5	//	61	//	184	30	1	TR	404	404	451
										RF	465	465	519
109-111	B6395	53-55	53,5	//	65	//	190	31	1	TR	404	404	451
										RF	465	465	519
113-115	B6396	56,5-58,5	53,5	//	65	//	195	32	1	TR	409	409	458
										RF	471	471	527
117-119	B6397	60,5-62,5	53,5	//	65	//	201	33	1	TR	411	411	463
										RF	473	473	533
119-121	B6398	62,5-64,5	53,5	//	65	//	209	34	1	TR	411	411	463
										RF	473	473	533

Tempi di consegna

1-2 settimane

2-3 settimane

3-4 settimane

N.B. I valori della tabella prezzi si riferiscono ad un singolo lato: sommare l'importo dei due codici con la misura desiderata per ottenere il prezzo totale di un box doccia ad angolo quadrato o rettangolare.

Nota: apertura determinata con due lati della stessa misura. Il lato singolo NON è abbinabile alla parete fissa. Per il trattamento StarClean considerare un aumento di una settimana dei tempi di consegna

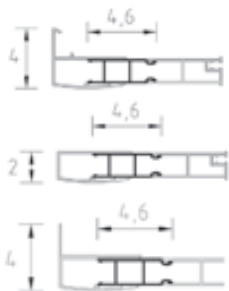

Profilo di compensazione optional

Altezza [cm]	Cod.	Estensibilità [cm]	L91 [€]	L96 [€]	ULU [€]
190	COM7A	0-4	90	90	90

Prodotti Speciali	Misure limite	I [€]	II [€]	III [€]
		H max 200 cm / L max 130 cm - min 50 cm	100	125

Modulo di richiesta disponibile on-line sul sito: www.samo.it/it/prodotti-speciali - In caso di annullamento dopo l'accettazione, sarà addebitato il costo totale dell'ordine.



Tattamento anticalcare optional da inserire al momento dell'ordine € 50

America 4 SP



Finitura pannelli

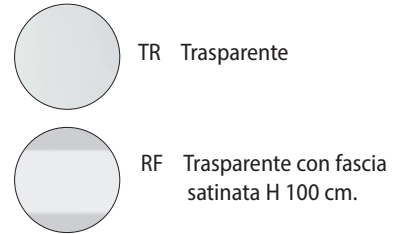



Profili in alluminio

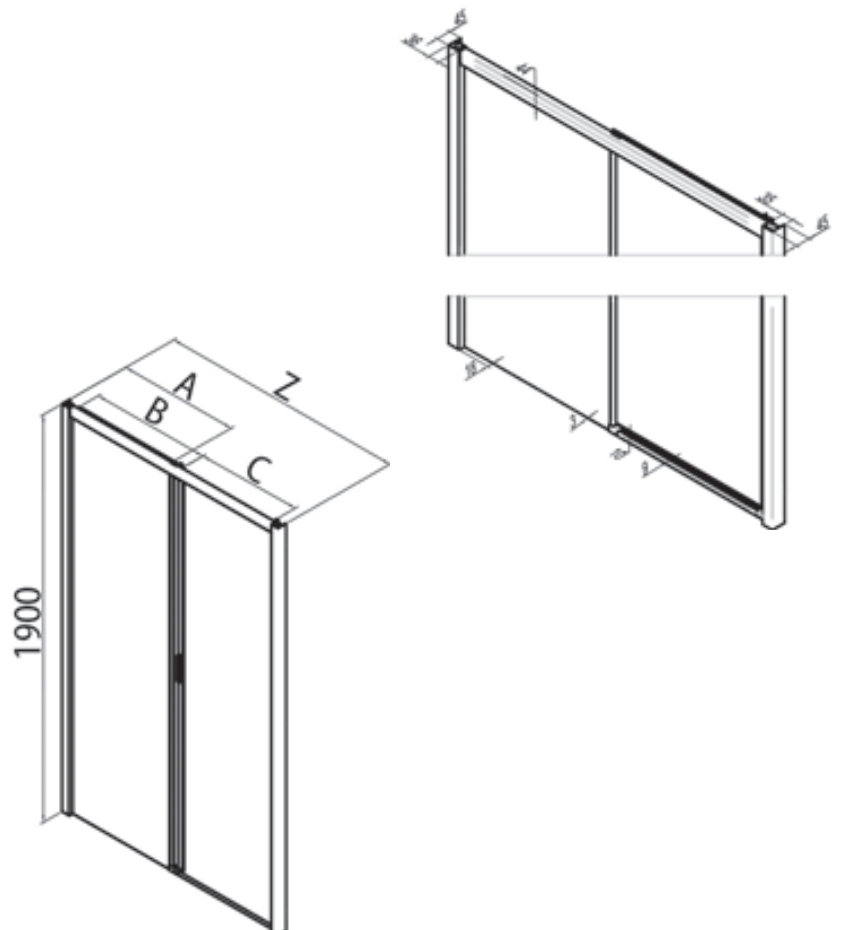

Porta scorrevole a due ante, apertura laterale ad anta scorrevole, una fissa ed una apribile.



Inquadrare il QR code per collegarsi alla pagina del sito www.samo.it per vedere altre combinazioni di pannelli e vetri

Z [cm]	Cod.	A [cm]	B [cm]	C [cm]	 [dm³]	 [kg]	 [n°]	Pannelli	L91 [€]	L96 [€]	ULU [€]
96-100	B6340	46-48	46,5	40	121	24	1	TR	592	592	646
								RF	681	681	743
100-104	B6341	48-50	48,5	41	126	25	1	TR	592	592	646
								RF	681	681	743
106-110	B6342	51-53	51,5	44	132	26	1	TR	592	592	646
								RF	681	681	743
110-114	B6343	53-55	53,5	46	137	27	1	TR	592	592	646
								RF	681	681	743
116-120	B6344	56,5-58,5	56	49	143	28	1	TR	592	592	646
								RF	681	681	743
120-124	B6345	58-60	58,5	51	149	29	1	TR	625	625	679
								RF	719	719	781
126-130	B6346	61-63	61,5	54	155	30	1	TR	625	625	679
								RF	719	719	781
130-134	B6347	65-67	61,5	54	161	31	1	TR	658	658	712
								RF	757	757	819
136-140	B6348	66-68	66,5	59	167	32	1	TR	692	692	749
								RF	796	796	862
140-144	B6349	70-72	66,5	59	173	33	1	TR	692	692	749
								RF	796	796	862
146-150	B6350	71-73	71,5	64	179	34	1	TR	730	730	789
								RF	840	840	908
156-160	B6351	76-78	76,5	69	185	35	1	TR	768	768	829
								RF	884	884	954
160-164	B6352	80-82	76,5	69	191	36	1	TR	768	768	829
								RF	884	884	954
166-170	B6354	81-83	81,5	74	197	37	1	TR	810	810	872
								RF	932	932	1003
170-174	B6356	85-87	81,5	74	203	38	1	TR	810	810	872
								RF	932	932	1003
176-180	B6358	86-88	86,5	79	209	39	1	TR	810	810	872
								RF	932	932	1003

Tempi di consegna

1-2 settimane

2-3 settimane

3-4 settimane

N.B. NON reversibile, indicare se DX o SX. Per il trattamento StarClean considerare un aumento di una settimana dei tempi di consegna

Prodotti Speciali	Misure limite	I [€]	II [€]	III [€]
	H max 200 cm / L max 180 cm - min 80 cm	100	125	140

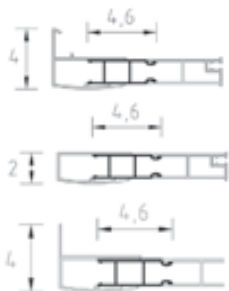
Modulo di richiesta disponibile on-line sul sito: www.samo.it/it/prodotti-speciali - In caso di annullamento dopo l'accettazione, sarà addebitato il costo totale dell'ordine.

Profilo di compensazione optional

Altezza [cm]	Cod.	Estensibilità [cm]	L91 [€]	L96 [€]	ULU [€]
190	COM7A	0-4	90	90	90

Parete fissa per abbinamenti (pag. 298)

Cod.	B6321	B6322	B6323	B6324	B6325	B6326	B6327	B6328	B6329
Estensibilità [cm]	63-65	67-69	69-71	73-75	77-79	79-81	83-85	87-89	89-91



Trattamento anticallcare optional da inserire al momento dell'ordine € 50

America 4 SP

H 190 cm.
V 4 mm.

Porta scorrevole a quattro ante



Finitura pannelli

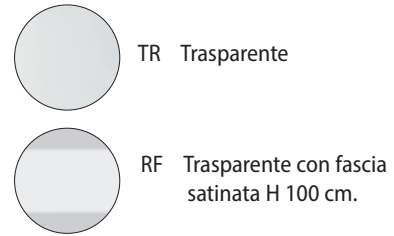

Profili in alluminio



Porta scorrevole a quattro ante, con apertura centrale ad ante scorrevoli, due fisse e due apribili.

Z [cm]	Cod.	A [cm]	B [cm]	C [cm]	[dm ³]	[kg]	[n°]	Pannelli	L91 [€]	L96 [€]	ULU [€]
136-140	B6363	35-37	34	56	170	35	1	TR	734	734	795
								RF	845	845	915
140-144	B6364	36-38	35	57	176	37	1	TR	734	734	795
								RF	845	845	915
146-150	B6365	37-39	37	61	184	38	1	TR	764	764	829
								RF	879	879	954
150-154	B6366	38-40	38	63	197	39	1	TR	764	764	829
								RF	879	879	954
156-160	B6367	40-42	39	65	202	40	1	TR	794	794	860
								RF	914	914	989
160-164	B6368	41-43	40	67	209	41	1	TR	794	794	860
								RF	914	914	989
166-170	B6369	42-44	42	71	218	42	1	TR	827	827	889
								RF	952	952	1023

Tempi di consegna

1-2 settimane

2-3 settimane

3-4 settimane

Prodotti Speciali: si veda pagina 299



Inquadrare il QR code per collegarsi alla pagina del sito www.samo.it per vedere altre combinazioni di pannelli e vetri

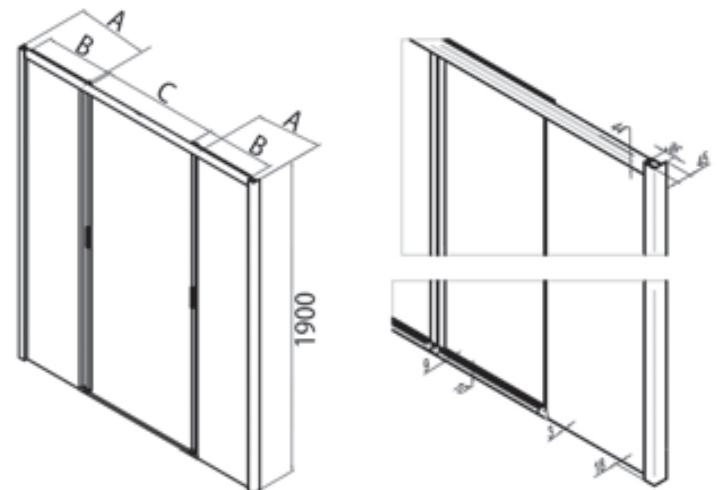

Tattamento anticalcare optional da inserire al momento dell'ordine € 100

America 4 SP

H 190 cm.
V 4 mm.

Porta a saloon



Finitura pannelli

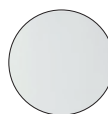

TR Trasparente

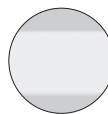

RF Trasparente con fascia satinata H 100 cm.

Profili in alluminio



ULU Brillantato cromo

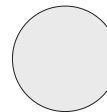

L91 Bianco opaco



L96 Nero opaco

Porta a saloon, apertura ad ante battenti verso l'interno e verso l'esterno.

Z [cm]	Cod.	A [cm]	B [cm]	C [cm]	[dm ³]	[kg]	[n°]	Pannelli	L91 [€]	L96 [€]	ULU [€]
66-70	B6331	//	24	54	117	16	1	TR	572	572	620
								RF	658	658	713
70-74	B6332	//	26	58	131	18	1	TR	572	572	620
								RF	658	658	713
76-80	B6333	//	29	64	148	19	1	TR	597	597	648
								RF	687	687	746
80-84	B6334	//	31	68	155	20	1	TR	597	597	648
								RF	687	687	746
86-90	B6335	//	34	74	163	21	1	TR	621	621	676
								RF	715	715	778
90-94	B6336	//	36	78	170	22	1	TR	621	621	676
								RF	715	715	778
96-100	B6337	//	39	84	175	23	1	TR	649	649	701
								RF	747	747	807

Tempi di consegna

1-2 settimane

2-3 settimane

3-4 settimane

Prodotti Speciali: si veda pagina 299



Inquadrare il QR code per collegarsi alla pagina del sito www.samo.it per vedere altre combinazioni di pannelli e vetri

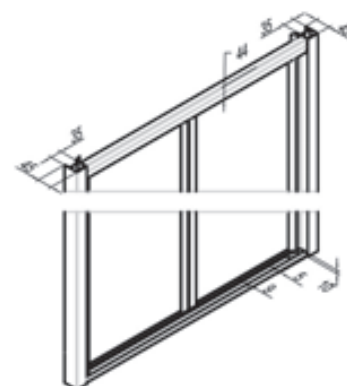
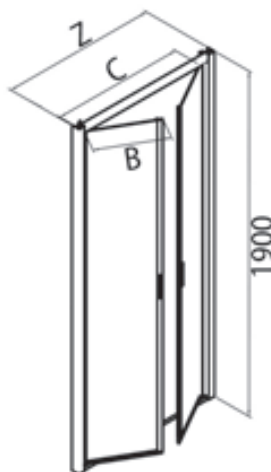

StarClean

Trattamento anticalcare optional da inserire al momento dell'ordine € 50

America 4 SP

H 190 cm.
V 4 mm.

Parete fissa per abbinamenti



190
cm

4
mm



Finitura pannelli

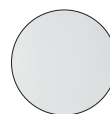

TR Trasparente

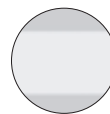

RF Trasparente con fascia satinata H 100 cm.

Profili in alluminio



ULU Brillantato cromo

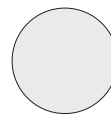

L91 Bianco opaco



L96 Nero opaco

Parete fissa per abbinamenti è possibile formare cabine doccia a due o tre lati, anche misure rettangolari.

Z [cm]	Cod.	A [cm]	B [cm]	C [cm]	[dm ³]	[kg]	[n°]	Pannelli	L91 [€]	L96 [€]	ULU [€]
63-65	B6321	//	//	//	117	16	1	TR	299	299	356
								RF	344	344	410
67-69	B6322	//	//	//	131	18	1	TR	299	299	356
								RF	344	344	410
69-71	B6323	//	//	//	148	19	1	TR	299	299	356
								RF	344	344	410
73-75	B6324	//	//	//	155	20	1	TR	299	299	356
								RF	344	344	410
77-79	B6325	//	//	//	163	21	1	TR	316	316	377
								RF	364	364	434
79-81	B6326	//	//	//	170	22	1	TR	316	316	377
								RF	364	364	434
83-85	B6327	//	//	//	175	23	1	TR	316	316	377
								RF	364	364	434
87-89	B6328	//	//	//	170	22	1	TR	338	338	398
								RF	389	389	458
89-91	B6329	//	//	//	175	23	1	TR	338	338	398
								RF	389	389	458

Tempi di consegna

1-2 settimane

2-3 settimane

3-4 settimane



Prodotti Speciali: si veda pagina 299



Inquadrare il QR code per collegarsi alla pagina del sito www.samo.it per vedere altre combinazioni di pannelli e vetri

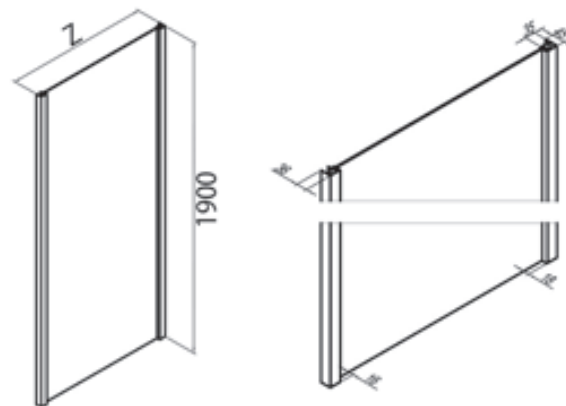

Trattamento anticalcare optional da inserire al momento dell'ordine € 50

Angolo a quattro ante

Prodotti Speciali	Misure limite	I [€]	II [€]	III [€]
	H max 200 cm / L max 150 cm - min 50 cm	100	125	140

Modulo di richiesta disponibile on-line sul sito: www.samo.it/it/prodotti-speciali - In caso di annullamento dopo l'accettazione, sarà addebitato il costo totale dell'ordine.

Rettangolare a quattro ante

Prodotti Speciali	Misure limite	I [€]	II [€]	III [€]
	H max 200 cm / L max 150 cm - min 50 cm	100	125	140

Modulo di richiesta disponibile on-line sul sito: www.samo.it/it/prodotti-speciali - In caso di annullamento dopo l'accettazione, sarà addebitato il costo totale dell'ordine.

Lato Angolo

Prodotti Speciali	Misure limite	I [€]	II [€]	III [€]
	H max 200 cm / L max 150 cm - min 50 cm	100	125	140

Modulo di richiesta disponibile on-line sul sito: www.samo.it/it/prodotti-speciali - In caso di annullamento dopo l'accettazione, sarà addebitato il costo totale dell'ordine.

Porta scorrevole a due ante

Prodotti Speciali	Misure limite	I [€]	II [€]	III [€]
	H max 200 cm / L max 180 cm - min 80 cm	100	125	140

Modulo di richiesta disponibile on-line sul sito: www.samo.it/it/prodotti-speciali - In caso di annullamento dopo l'accettazione, sarà addebitato il costo totale dell'ordine.

Porta scorrevole a quattro ante

Prodotti Speciali	Misure limite	I [€]	II [€]	III [€]
	H max 200 cm / L max 180 cm - min 80 cm	130	160	200

Modulo di richiesta disponibile on-line sul sito: www.samo.it/it/prodotti-speciali - In caso di annullamento dopo l'accettazione, sarà addebitato il costo totale dell'ordine.

Porta a saloon

Prodotti Speciali	Misure limite	I [€]	II [€]	III [€]
	H max 200 cm / L max 120 cm - min 50 cm	100	125	140

Modulo di richiesta disponibile on-line sul sito: www.samo.it/it/prodotti-speciali - In caso di annullamento dopo l'accettazione, sarà addebitato il costo totale dell'ordine.

Parete fissa per abbinamenti

Prodotti Speciali	Misure limite	I [€]	II [€]	III [€]
	H max 200 cm - min 50 cm / L max 120 cm - min 15 cm	70	90	105

Modulo di richiesta disponibile on-line sul sito: www.samo.it/it/prodotti-speciali - In caso di annullamento dopo l'accettazione, sarà addebitato il costo totale dell'ordine.

America quattro



Finitura pannelli

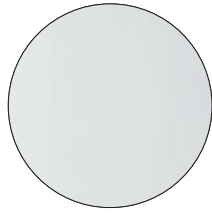

TR
Trasparente

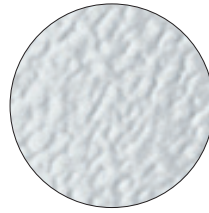

ST
Stampato

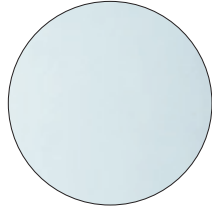

AS
Satinato Acqua

Profili in alluminio

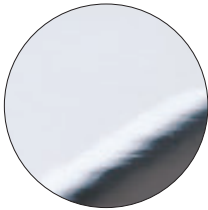

ULU
Brillantato cromo

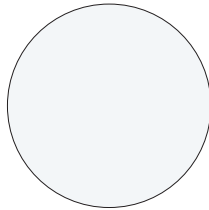

L91
Bianco opaco



NEW

L96
Nero opaco

Angolo

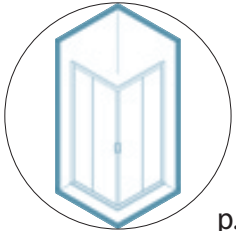

p. 302

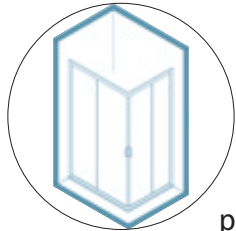

p. 303

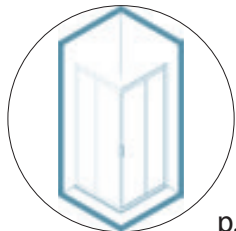

p. 304

Porta

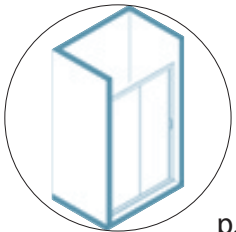

p. 306

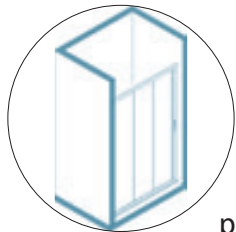

p. 308

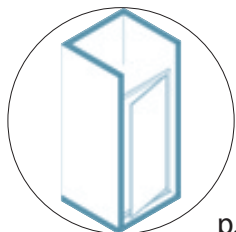

p. 309

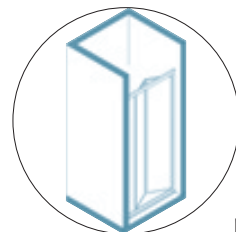

p. 310

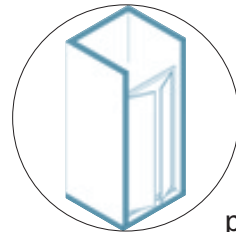

p. 311

Tondo

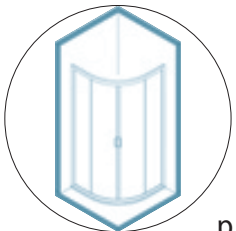

p. 312

Parete fissa

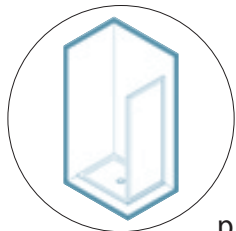

p. 313

America 4

H 190 cm.
V 4 mm.

Angolo a quattro ante



Finitura pannelli

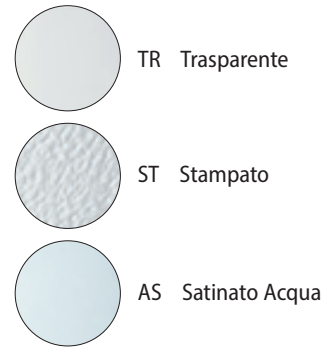

Profili in alluminio

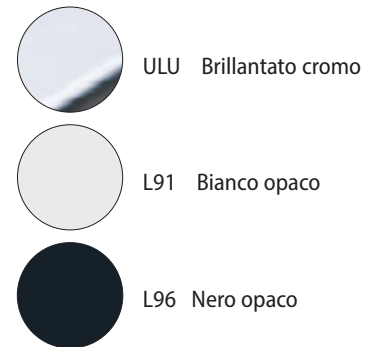

Angolo a quattro ante, apertura ad ante scorrevoli, due fisse e due apribili.

Z [cm]	Cod.	A [cm]	B [cm]	B1 [cm]	C [cm]	D [cm]	[dm ³]	[kg]	[n°]	Pannelli	L91-L96 [€]	ULU [€]
67-71	B6412	33,9-37,9	31,7	//	36	//	170	27	1	TR	588	638
										ST	606	658
										AS	647	702
73-77	B6414	36,9-40,9	34,7	//	40	//	176	28	1	TR	604	654
										ST	623	674
										AS	665	720
77-81	B6415	38,9-42,9	36,7	//	43	//	184	30	1	TR	621	673
										ST	640	694
										AS	684	741
83-87	B6417	41,9-45,9	39,7	//	47	//	197	31	1	TR	638	692
										ST	658	713
										AS	702	762
87-91	B6418	43,9-47,9	41,7	//	50	//	202	33	1	TR	656	709
										ST	676	731
										AS	722	780
Tempi di consegna						1-2 settimane	2-3 settimane	3-4 settimane				

Prodotti Speciali	Misure limite	I [€]	II [€]	III [€]
	H max 200 cm / L max 130 cm - min 50 cm	100	125	140



Inquadrare il QR code per collegarsi alla pagina del sito www.samo.it per vedere altre combinazioni di pannelli e vetri

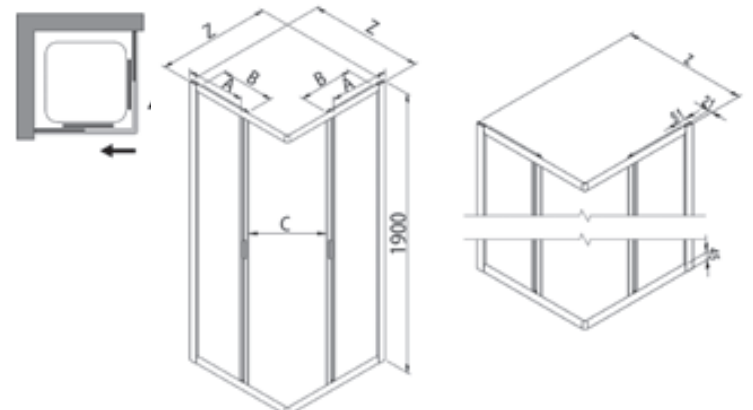

StarClean

Trattamento anticalcare optional da inserire al momento dell'ordine € 100
Per il trattamento StarClean considerare un aumento di una settimana dei tempi di consegna

302 samo

America 4

H 190 cm.
V 4 mm.

Rettangolare a quattro ante



Finitura pannelli

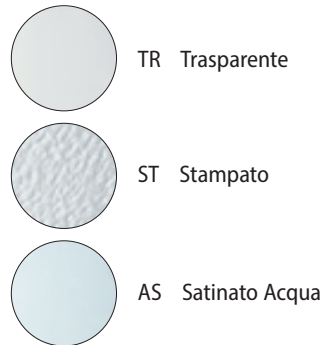

Profili in alluminio

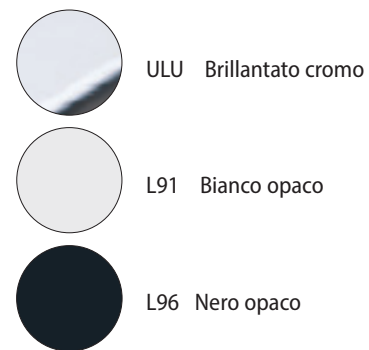

Angolo rettangolare a quattro ante, apertura ad ante scorrevoli, due fisse e due apribili.

Z [cm]	Cod.	A [cm]	B [cm]	B1 [cm]	C [cm]	D [cm]	[dm³]	[kg]	[n°]	Pannelli	L91-L96 [€]	ULU [€]
67-71/87-91	B6472	33,9-37,9	31,7	41,7	43	43,9-47,9	197	31	1	TR	638	711
										ST	658	733
										AS	702	783
67-71/97-101	B6478	33,9-37,9	31,7	46,7	46,5	48,9-52,9	202	33	1	TR	664	753
										ST	684	776
										AS	731	829
67-71/117-121	B6479	33,9-37,9	31,7	56,7	53,5	58,9-62,9	223	37	1	TR	693	788
										ST	714	812
										AS	763	867
73-77/87-91	B6474	36,9-40,9	34,7	41,7	45	43,9-47,9	206	34	1	TR	630	682
										ST	649	703
										AS	693	751
73-77/97-101	B6475	36,9-40,9	34,7	46,7	48,5	48,9-52,9	206	34	1	TR	641	731
										ST	661	753
										AS	706	805
77-81/97-101	B6476	38,9-42,9	36,7	46,7	50	48,9-52,9	206	34	1	TR	647	736
										ST	667	759
										AS	712	810
77-81/117-121	B6477	38,9-42,9	36,7	56,7	57	58,9-62,9	206	34	1	TR	711	809
										ST	733	834
										AS	783	890

Prodotti Speciali	Misure limite	I [€]	II [€]	III [€]
		H max 200 cm / L max 130 cm - min 50 cm	100	125



Inquadrare il QR code per collegarsi alla pagina del sito www.samo.it per vedere altre combinazioni di pannelli e vetri

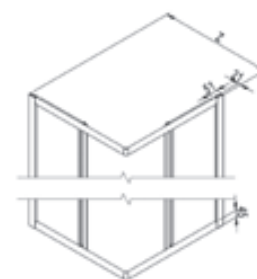
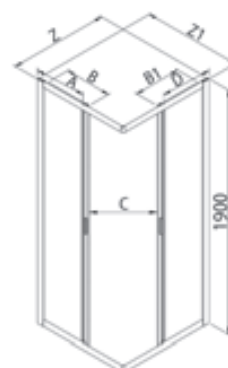
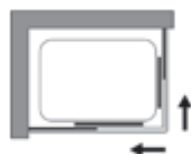

Trattamento anticalcare optional da inserire al momento dell'ordine € 100
Per il trattamento StarClean considerare un aumento di una settimana dei tempi di consegna

samo 303

America 4



Finitura pannelli

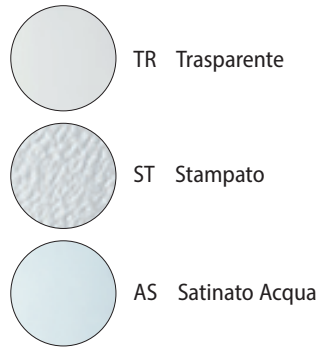

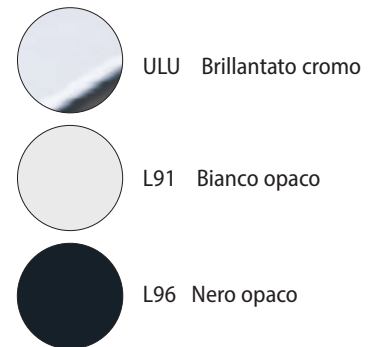

Profili in alluminio

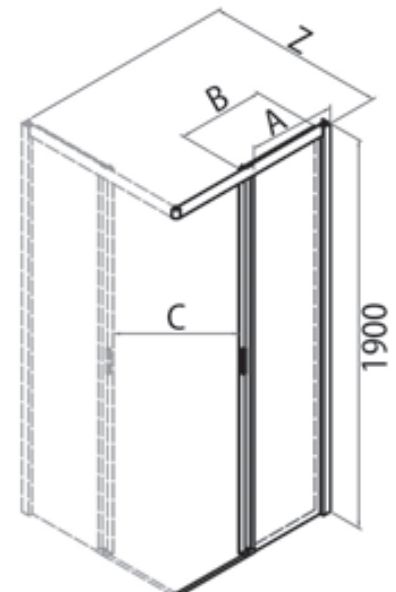
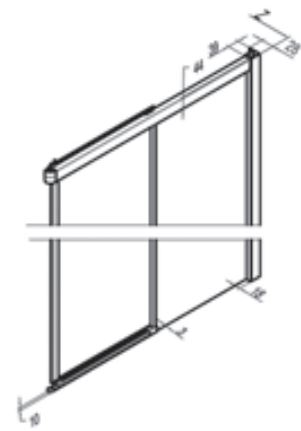

Lato angolo a due ante, apertura ad ante scorrevoli, una fissa e una apribile.



Z [cm]	Cod.	A [cm]	B [cm]	C [cm]	 [dm ³]	 [kg]	 [n°]	Pannelli	L91-L96 [€]	ULU [€]
67-71	B6482	33,9-37,9	31,7	36	118	19	1	TR	326	353
								ST	336	364
								AS	359	389
73-77	B6484	36,9-40,9	34,7	40	122	20	1	TR	326	353
								ST	336	364
								AS	359	389
77-81	B6485	38,9-42,9	36,7	43	128	21	1	TR	344	362
								ST	355	373
								AS	379	399
83-87	B6487	41,9-45,9	39,7	47	137	22	1	TR	344	362
								ST	355	373
								AS	379	399
87-91	B6488	43,9-47,9	41,7	50	140	23	1	TR	352	373
								ST	363	385
								AS	388	411
93-97	B6490	47,1-51,1	44,9	54,5	145	24	1	TR	352	373
								ST	363	385
								AS	388	411
97-101	B6491	48,9-52,9	46,7	57	151	25	1	TR	359	408
								ST	370	421
								AS	395	449
103-107	B6493	52,1-56,1	49,9	61,5	155	26	1	TR	359	408
								ST	370	421
								AS	395	449
107-111	B6494	53,9-57,9	51,7	64	160	27	1	TR	362	414
								ST	373	427
								AS	399	456
117-121	B6497	58,9-62,9	56,7	71	168	28	1	TR	380	454
								ST	392	468
								AS	418	500

Tempi di consegna

1-2 settimane

2-3 settimane

3-4 settimane

N.B. I valori della tabella prezzi si riferiscono ad un singolo lato: sommare l'importo dei due codici con la misura desiderata per ottenere il prezzo totale di un box doccia ad angolo quadrato o rettangolare.

Nota: apertura determinata con due lati della stessa misura. Il lato singolo NON è abbinabile alla parete fissa. Per il trattamento StarClean considerare un aumento di una settimana dei tempi di consegna

Prodotti Speciali	Misure limite	I [€]	II [€]	III [€]
	H max 200 cm / L max 130 cm - min 50 cm	100	125	140

Modulo di richiesta disponibile on-line sul sito: www.samo.it/it/prodotti-speciali - In caso di annullamento dopo l'accettazione, sarà addebitato il costo totale dell'ordine.

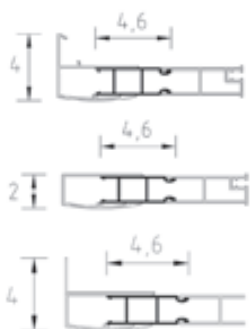

Profilo di compensazione optional

Altezza [cm]	Cod.	Estensibilità [cm]	L91 [€]	L96 [€]	ULU [€]
190	COM7A	0-4	90	90	90



Trattamento anticalcare optional da inserire al momento dell'ordine € 50
Per il trattamento StarClean considerare un aumento di una settimana dei tempi di consegna



Inquadrare il QR code per collegarsi alla pagina del sito www.samo.it
per vedere altre combinazioni di pannelli e vetri

America 4



Finitura pannelli

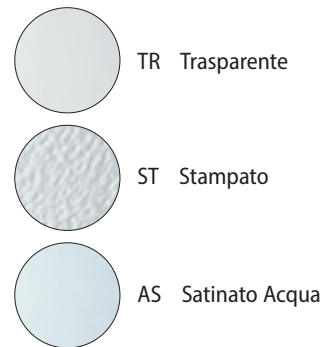

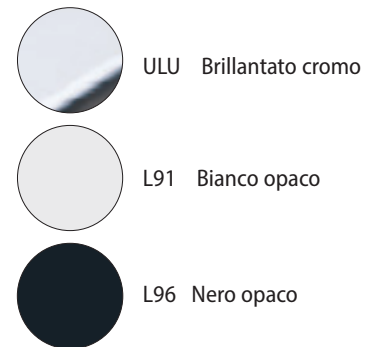

Profili in alluminio

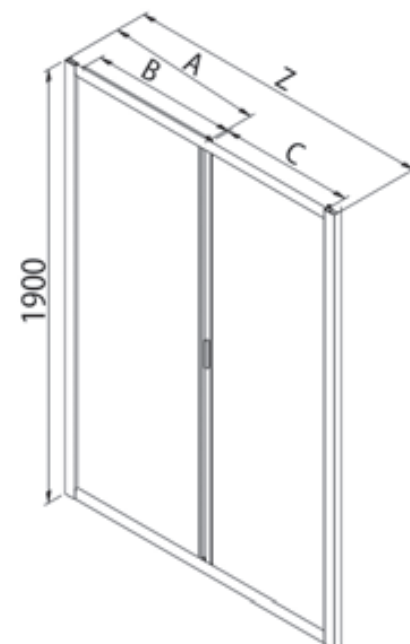
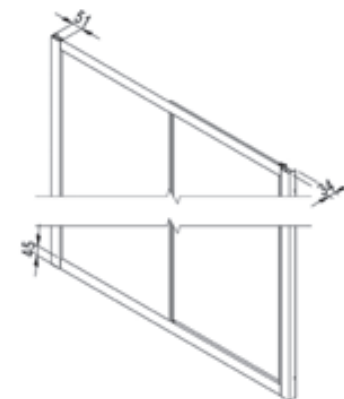

Porta scorrevole a due ante, apertura laterale ad anta scorrevole, una fissa ed una apribile.



Z [cm]	Cod.	A [cm]	B [cm]	C [cm]	 [dm³]	 [kg]	 [n°]	Pannelli	L91-L96 [€]	ULU [€]
96-103	B6440	47,1-51,1	44,9	38,5	121	24	1	TR	505	587
								ST	521	605
								AS	556	646
106-113	B6442	52,1-56,1	49,9	43,5	126	25	1	TR	505	587
								ST	521	605
								AS	556	646
116-123	B6444	57,1-61,1	54,9	48,5	132	26	1	TR	533	616
								ST	549	635
								AS	587	678
126-133	B6446	62,1-66,1	59,9	53,5	137	27	1	TR	561	648
								ST	578	668
								AS	618	713
136-143	B6448	67,1-71,1	64,9	58,5	143	28	1	TR	591	681
								ST	609	702
								AS	651	750
146-153	B6450	72,1-76,1	69,9	63,5	149	29	1	TR	622	718
								ST	641	740
								AS	685	790
156-163	B6452	77,1-81,1	74,9	68,5	155	30	1	TR	656	753
								ST	676	776
								AS	722	829
166-173	B6454	82,1-86,1	79,9	73,5	161	31	1	TR	690	793
								ST	711	817
								AS	759	873
Tempi di consegna					1-2 settimane	2-3 settimane	3-4 settimane			

Per il trattamento StarClean considerare un aumento di una settimana dei tempi di consegna

Prodotti Speciali	Misure limite	I [€]	II [€]	III [€]
	H max 200 cm / L max 180 cm - min 80 cm	100	125	140

Modulo di richiesta disponibile on-line sul sito: www.samo.it/it/prodotti-speciali - In caso di annullamento dopo l'accettazione, sarà addebitato il costo totale dell'ordine.

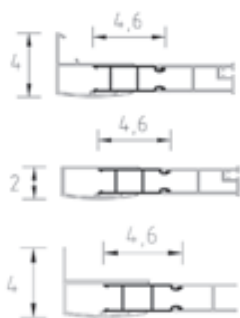

Profilo di compensazione optional

Altezza [cm]	Cod.	Estensibilità [cm]	L91 [€]	L96 [€]	ULU [€]
190	COM7A	0-4	90	90	90

Parete fissa per abbinamenti (pag. 313)

Cod.	B6421	B6422	B6424	B6425	B6427	B6428	B6429
Estensibilità [cm]	63-67	67-71	73-77	77-81	83-87	87-91	97-101



Trattamento anticalcare optional da inserire al momento dell'ordine € 50
Per il trattamento StarClean considerare un aumento di una settimana dei tempi di consegna



Inquadrare il QR code per collegarsi alla pagina del sito www.samo.it per vedere altre combinazioni di pannelli e vetri



America 4

H 190 cm.
V 4 mm.

Porta scorrevole a tre ante



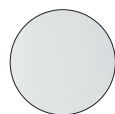

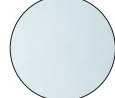
Finitura pannelli

-  TR Trasparente
-  ST Stampato
-  AS Satinato Acqua

Profili in alluminio

-  ULU Brillantato cromo
-  L91 Bianco opaco
-  L96 Nero opaco

Porta scorrevole a tre ante, apertura laterale ad anta scorrevole, una fissa ed due apribili.

Z [cm]	Cod.	A [cm]	B [cm]	C [cm]	 [dm ³]	 [kg]	 [n°]	Pannelli	L91-L96 [€]	ULU [€]
68-76	B6408	27,3 - 31,3	21,2	32	132	19	1	TR	464	545
								ST	478	562
								AS	511	600
77-85	B6409	30,3 - 34,3	24,2	38	137	21	1	TR	484	573
								ST	499	591
								AS	533	631
86-94	B6410	33,3 - 37,3	27,2	44	143	23	1	TR	504	594
								ST	520	612
								AS	555	654
95-103	B6411	36,3 - 40,3	30,2	50	149	25	1	TR	528	622
								ST	544	641
								AS	581	685
104-112	B6455	39,3 - 43,3	33,2	56	153	26	1	TR	549	647
								ST	566	667
								AS	604	712
113-121	B6456	42,3 - 46,3	36,2	62	159	29	1	TR	572	676
								ST	590	697
								AS	630	744

Prodotti Speciali	Misure limite	I [€]	II [€]	III [€]
	H max 200 cm / L max 140 cm - min 60 cm	100	125	140



Inquadrare il QR code per collegarsi alla pagina del sito www.samo.it per vedere altre combinazioni di pannelli e vetri



Treatmento anticalcare optional da inserire al momento dell'ordine € 100
Per il trattamento StarClean considerare un aumento di una settimana dei tempi di consegna

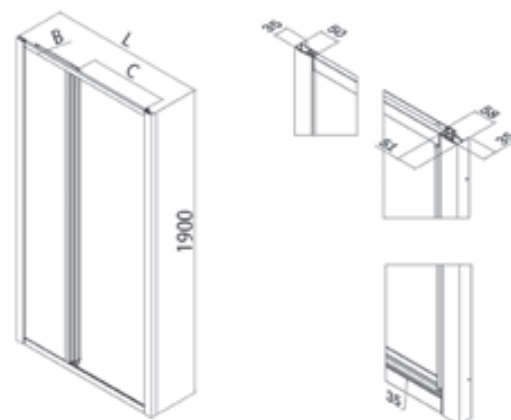

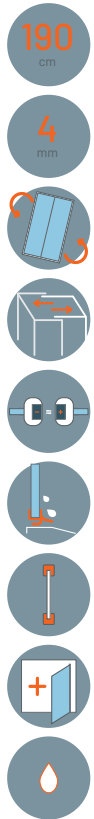

Finitura pannelli

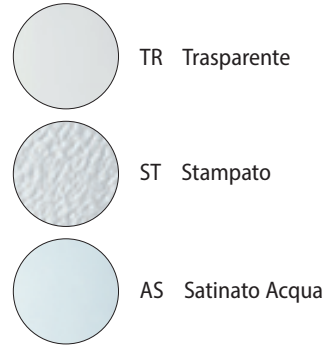

Profili in alluminio

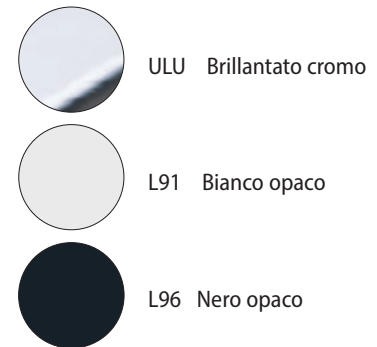

Porta ad un'anta a battente con apertura verso l'interno e l'esterno.

Z [cm]	Cod.	A [cm]	B [cm]	C [cm]	[dm³]	[kg]	[n°]	Pannelli	L91-L96 [€]	ULU [€]
66-74	B6401	//	51,8	52	117	16	1	TR	415	488
								ST	428	503
								AS	457	537
76-84	B6403	//	61,8	62	131	18	1	TR	435	509
								ST	449	525
								AS	479	560
86-94	B6405	//	71,8	72	148	19	1	TR	456	535
								ST	470	552
								AS	502	589
96-104	B6407	//	81,8	82	155	20	1	TR	456	535
								ST	470	552
								AS	502	589

Tempi di consegna

1-2 settimane

2-3 settimane

3-4 settimane

Prodotti Speciali	Misure limite	I [€]	II [€]	III [€]
	H max 200 cm / L max 100 cm - min 50 cm	100	125	140

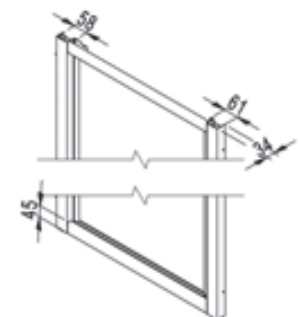

Inquadrare il QR code per collegarsi alla pagina del sito www.samo.it per vedere altre combinazioni di pannelli e vetri



Trattamento anticalcare optional da inserire al momento dell'ordine € 50
Per il trattamento StarClean considerare un aumento di una settimana dei tempi di consegna



America 4

H 190 cm.
V 4 mm.

Porta a due ante a soffietto



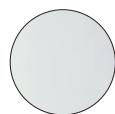

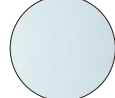
Finitura pannelli

-  TR Trasparente
-  ST Stampato
-  AS Satinato Acqua

Profili in alluminio

-  ULU Brillantato cromo
-  L91 Bianco opaco
-  L96 Nero opaco

Porta a due ante a soffietto, apertura con ante pieghevoli **verso l'interno e verso l'esterno**.

Z [cm]	Cod.	A [cm]	B [cm]	C [cm]	 [dm ³]	 [kg]	 [n°]	Pannelli	L91-L96 [€]	ULU [€]
66-74	B6461	//	28,8	36	118	16	1	TR	544	626
								ST	561	645
								AS	599	689
76-84	B6463	//	34	46	122	20	1	TR	563	651
								ST	580	671
								AS	620	717
86-94	B6465	//	38,7	56	128	21	1	TR	585	675
								ST	603	696
								AS	644	743
96-104	B6467	//	43,6	66	137	22	1	TR	608	698
								ST	627	719
								AS	669	768

Tempi di consegna	1-2 settimane	2-3 settimane	3-4 settimane
-------------------	---------------	---------------	---------------

Prodotti Speciali	Misure limite	I [€]	II [€]	III [€]
	H max 200 cm / L max 120 cm - min 50 cm	100	125	140



Inquadrare il QR code per collegarsi alla pagina del sito www.samo.it per vedere altre combinazioni di pannelli e vetri

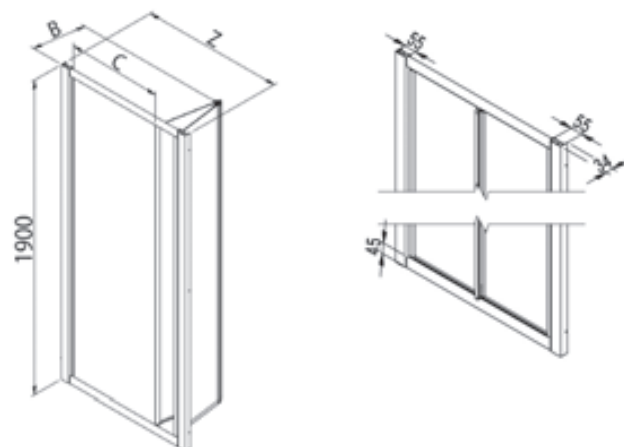

Trattamento anticalcare optional da inserire al momento dell'ordine € 50
Per il trattamento StarClean considerare un aumento di una settimana dei tempi di consegna

America 4

H 190 cm.
V 4 mm.

Porta a saloon



Finitura pannelli

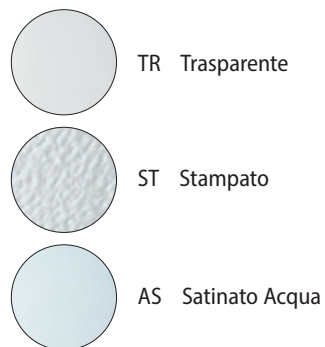

Profili in alluminio

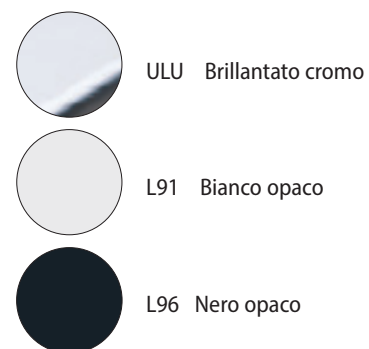

Porta a saloon, apertura ad ante battenti **verso l'interno e verso l'esterno.**

Z [cm]	Cod.	A [cm]	B [cm]	C [cm]	[dm ³]	[kg]	[n°]	Pannelli	L91-L96 [€]	ULU [€]
66-74	B6431	//	25	49,5	117	16	1	TR	488	564
								ST	503	581
								AS	537	621
76-84	B6433	//	30	59,5	131	18	1	TR	509	589
								ST	525	607
								AS	560	648
86-94	B6435	//	35	69,5	148	19	1	TR	530	614
								ST	546	633
								AS	583	676
96-104	B6437	//	40	79,5	155	20	1	TR	552	637
								ST	569	657
								AS	608	701

Tempi di consegna

1-2 settimane

2-3 settimane

3-4 settimane

Prodotti Speciali	Misure limite	I [€]	II [€]	III [€]
	H max 200 cm / L max 120 cm - min 50 cm	100	125	140



Inquadrare il QR code per collegarsi alla pagina del sito www.samo.it per vedere altre combinazioni di pannelli e vetri

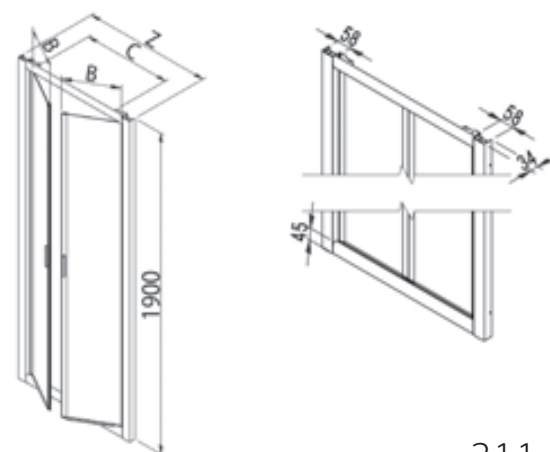

Trattamento anticalcare optional da inserire al momento dell'ordine € 50
Per il trattamento StarClean considerare un aumento di una settimana dei tempi di consegna

America 4

H 190 cm.
V 4 mm.

Tondo scorrevole a quattro ante



Finitura pannelli

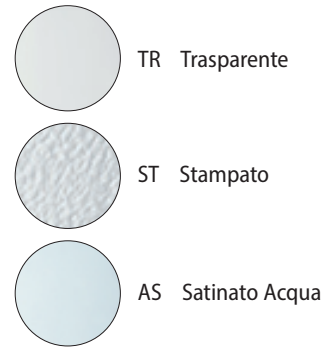

Profili in alluminio

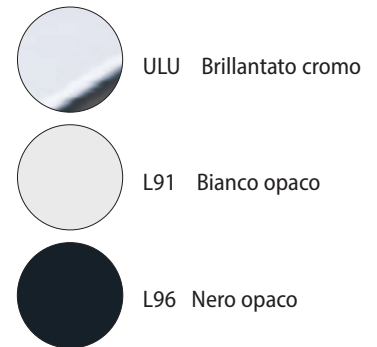

Tondo scorrevole a quattro ante, due fisse laterali e due apribili frontali.

Z [cm]	Cod.	A [cm]	B [cm]	C [cm]	[dm³]	[kg]	[n°]	Pannelli	L91-L96 [€]	ULU [€]
71,5-75,5	B6470	33,9-37,9	28,3	41	42-44	31	1	TR	846	985
								ST	872	1015
								AS	931	1084
76-80	B6473	21,5-25,5	41,3	36	43-45	33	1	TR	862	998
								ST	888	1028
								AS	949	1098
86-90	B6471	31,5-35,5	41,3	51,5	48-50	37	1	TR	883	1028
								ST	910	1059
								AS	972	1131

Tempi di consegna	1-2 settimane	2-3 settimane	3-4 settimane
-------------------	---------------	---------------	---------------

Prodotti Speciali	Misure limite	I [€]	II [€]	III [€]
	H max 190 cm / Larghezza max e min richiedere fattibilità	275	//	350



Inquadrare il QR code per collegarsi alla pagina del sito www.samo.it per vedere altre combinazioni di pannelli e vetri

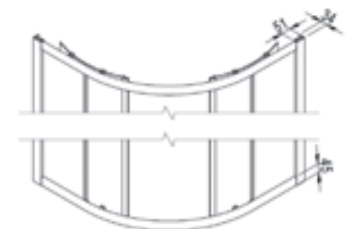
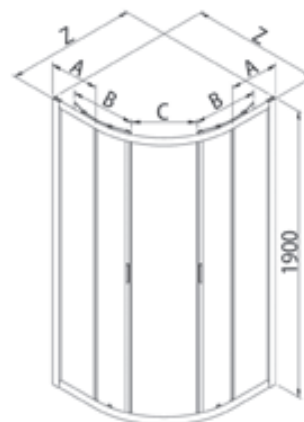

Tattamento anticalcare optional da inserire al momento dell'ordine € 100
Per il trattamento StarClean considerare un aumento di una settimana dei tempi di consegna



America 4

H 190 cm.
V 4 mm.

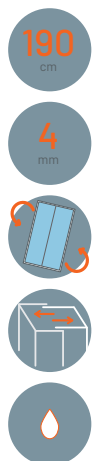

Parete fissa per abbinamenti

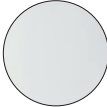

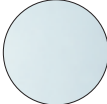

Finitura pannelli

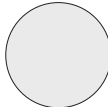
-  TR Trasparente
-  ST Stampato
-  AS Satinato Acqua

Profili in alluminio

-  ULU Brillantato cromo
-  L91 Bianco opaco
-  L96 Nero opaco

Parete fissa per abbinamenti è possibile formare cabine doccia a due o tre lati, anche misure rettangolari.

Z [cm]	Cod.	A [cm]	B [cm]	C [cm]	 [dm ³]	 [kg]	 [n°]	Pannelli	L91-L96 [€]	ULU [€]
63-67	B6421	//	//	//	118	15	1	TR	282	335
								ST	291	346
								AS	311	369
67-71	B6422	//	//	//	121	16	1	TR	282	335
								ST	291	346
								AS	311	369
73-77	B6424	//	//	//	123	17	1	TR	282	335
								ST	291	346
								AS	311	369
77-81	B6425	//	//	//	126	18	1	TR	300	353
								ST	309	364
								AS	330	389
83-87	B6427	//	//	//	130	19	1	TR	300	353
								ST	309	364
								AS	330	389
87-91	B6428	//	//	//	132	20	1	TR	319	374
								ST	329	386
								AS	351	412
97-101	B6429	//	//	//	135	21	1	TR	319	374
								ST	329	386
								AS	351	412

Tempi di consegna

1-2 settimane

2-3 settimane

3-4 settimane



Prodotti Speciali	Misure limite	I [€]	II [€]	III [€]
	H max 200 cm / L max 120 cm - min 17 cm	70	90	105

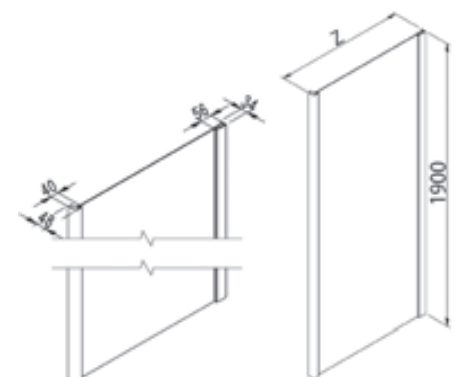

Treatmento anticalcare optional da inserire al momento dell'ordine € 50
Per il trattamento StarClean considerare un aumento di una settimana dei tempi di consegna

America



Finitura pannelli in vetro

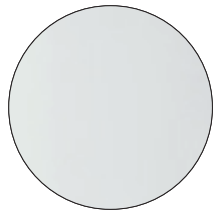

TR
Trasparente

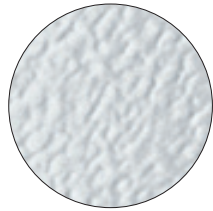

ST
Stampato

Finitura pannelli in polystirene

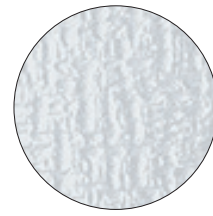

JU
Juta

Profili in alluminio

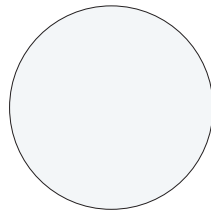

L01
Bianco

Angolo

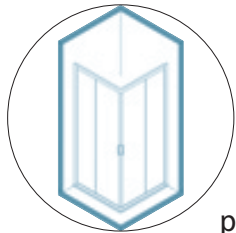

p. 316

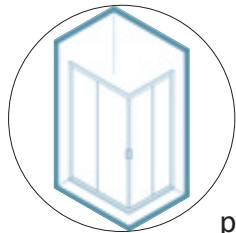

p. 318

Porta

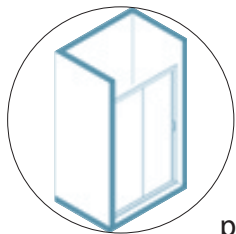

p. 317

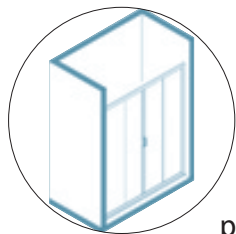

p. 320

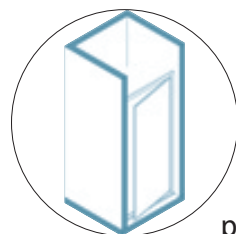

p. 321

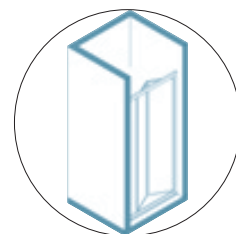

p. 322

Tondo

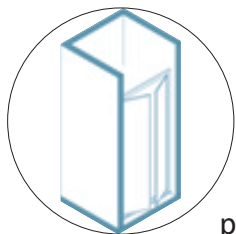

p. 323

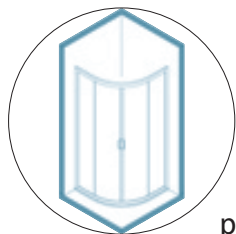

p. 324

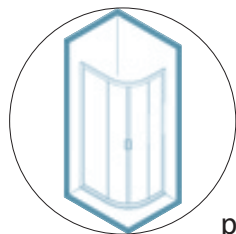

p. 325

Parete fissa

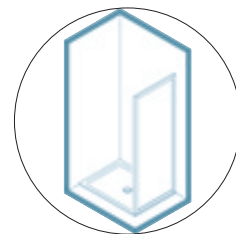

p. 326



Finitura pannelli in vetro



TR Trasparente



ST Stampato

Finitura pannelli in polystyrene

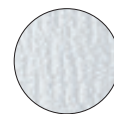

JU Juta

Profili in alluminio

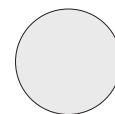

L01 Bianco

Angolo a quattro ante, apertura ad ante scorrevoli, due fisse e due apribili.

Z [cm]	Cod.	A [cm]	B [cm]	B1 [cm]	C [cm]	D [cm]	[dm ³]	[kg]	[n°]	Pannelli	L01 [€]
67-71	B6816	33,8-37,8	32	32	35	33,8-37,8	132	28	1	TR	490
										ST	505
										JU	491
73-77	B6817	36,8-40,8	35	35	39	36,8-40,8	142	30	1	TR	504
										ST	520
										JU	505
77-81	B6818	38,8-42,8	37	37	42	38,8-42,8	156	30	1	TR	517
										ST	533
										JU	519
83-87	B6822	41,8-45,8	40	40	46	41,8-45,8	171	34	1	TR	532
										ST	548
										JU	532
87-91	B6823	43,8-47,8	42	42	49	43,8-47,8	178	38	1	TR	545
										ST	562
										JU	545

Tempi di consegna

1-2 settimane

2-3 settimane

3-4 settimane

Prodotti Speciali	Misure limite	I [€]	II [€]	III [€]
	H max 200 cm / L max 130 cm - min 50 cm	100	125	140

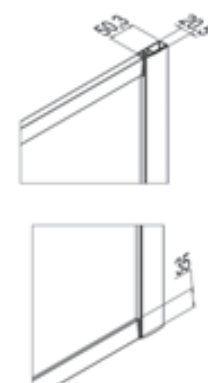
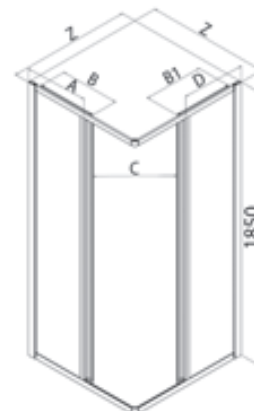
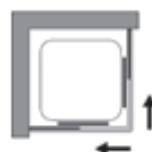

Inquadrare il QR code per collegarsi alla pagina del sito www.samo.it per vedere altre combinazioni di pannelli e vetri



Treatmento anticalcare optional da inserire al momento dell'ordine € 100
Per il trattamento StarClean considerare un aumento di una settimana dei tempi di consegna



Finitura pannelli in vetro

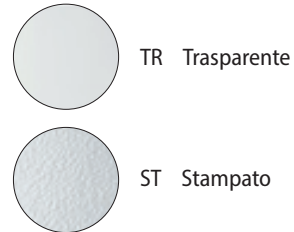

Finitura pannelli in polystyrene

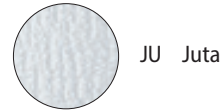

Profili in alluminio



Porta scorrevole a due ante, apertura laterale ad anta scorrevole, una fissa ed una apribile.

Z [cm]	Cod.	A [cm]	B [cm]	C [cm]	[dm³]	[kg]	[n°]	Pannelli	L01 [€]
113-120	B6841	54,7-58,7	54,8	47	119	26	1	TR	416
								ST	429
121-128	B6842	58,7-62,7	58,8	51	141	27	1	JU	418
								TR	439
								ST	453
129-136	B6843	63,9-67,9	61,6	54	149	27	1	JU	442
								TR	461
								ST	475
136-143	B6805	66,9-70,9	65,6	57	155	28	1	JU	465
								TR	488
								ST	503
146-153	B6806	72,2-76,2	70,3	62	166	29	1	JU	489
								TR	511
								ST	527
156-163	B6807	77,2-81,2	75,3	67	176	30	1	JU	517
								TR	539
								ST	556
166-173	B6808	82,2-86,2	80,3	72	186	31	1	JU	543
								TR	569
								ST	587
						20	1	JU	571

Prodotti Speciali	Misure limite	I [€]	II [€]	III [€]
	H max 200 cm / L max 185 cm - min 80 cm	125	175	190



Inquadrare il QR code per collegarsi alla pagina del sito www.samo.it per vedere altre combinazioni di pannelli e vetri



Trattamento anticalcare optional da inserire al momento dell'ordine € 50
Per il trattamento StarClean considerare un aumento di una settimana dei tempi di consegna

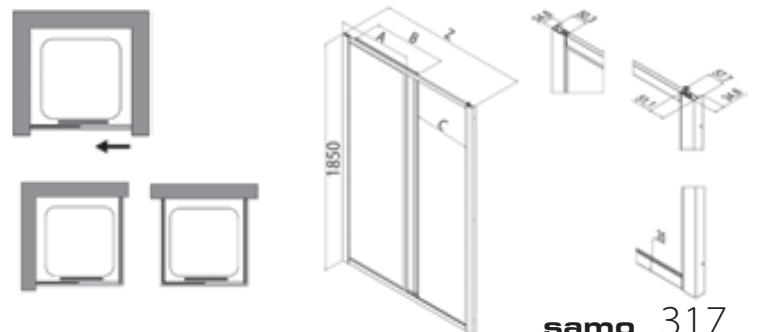

America



Angolo rettangolare a quattro ante, apertura ad ante scorrevoli, due fisse e due apribili.

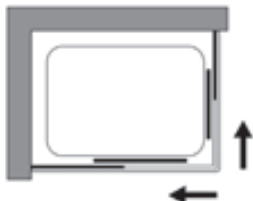

Finitura pannelli in vetro



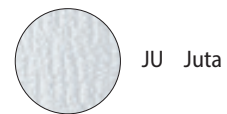

Finitura pannelli in polystirene

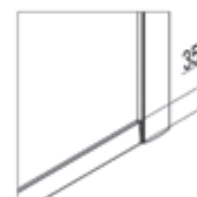
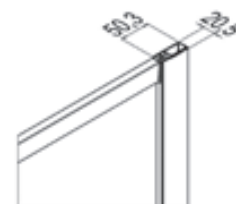
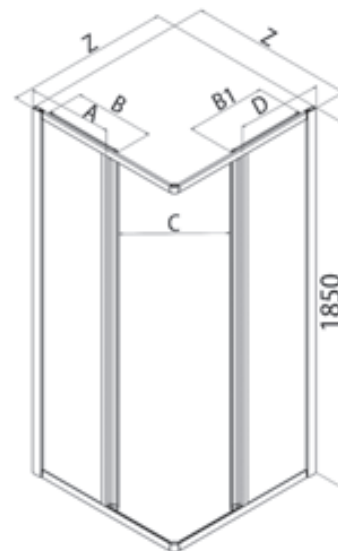
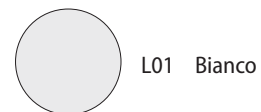

Profili in alluminio



Z [cm]	Cod.	A [cm]	B [cm]	B1 [cm]	C [cm]	D [cm]	 [dm ³]	 [kg]	 [n°]	Pannelli	L01 [€]
67-71/83-87	B6830	33,8-37,8	32	40	40	41,8-45,8	164	30	1	TR	509
										ST	525
										JU	511
67-71/87-91	B6838	33,8-37,8	32	42	42	43,8-47,8	247	35	1	TR	531
										ST	547
										JU	534
67-71/97-101	B6896	33,8-37,8	32	47	46	48,8-52,8	195	33	1	TR	551
										ST	566
										JU	556
67-71/107-111	B6897	33,8-37,8	32	52	51	53,8-57,8	215	35	1	TR	564
										ST	582
										JU	570
67-71/117-121	B6898	33,8-37,8	32	57	54	58,8-62,8	235	35	1	TR	576
										ST	592
										JU	579
73-77/77-81	B6825	36,8-40,8	35	37	43	38,8-42,8	158	31	1	TR	509
										ST	525
										JU	512
73-77/87-91	B6824	36,8-40,8	35	42	45	43,8-47,8	186	32	1	TR	523
										ST	539
										JU	525
73-77/97-101	B6850	36,8-40,8	35	47	48	48,8-52,8	192	33	1	TR	533
										ST	549
										JU	537
77-81/97-101	B6840	38,8-42,8	37	47	50	48,8-52,8	192	35	1	TR	538
										ST	555
										JU	542
77-81/117-121	B6899	38,8-42,8	37	57	58	58,8-62,8	247	36	1	TR	590
										ST	608
										JU	593

Tempi di consegna

1-2 settimane

2-3 settimane

3-4 settimane

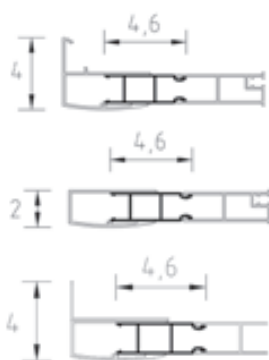

Profilo di compensazione optional

Altezza [cm]	Cod.	Estensibilità [cm]	L01 [€]
185	COM7	0-4	60

Prodotti Speciali	Misure limite	I [€]	II [€]	III [€]
	H max 200 cm / L max 130 cm - min 50 cm	100	125	140

Modulo di richiesta disponibile on-line sul sito: www.samo.it/it/prodotti-speciali - In caso di annullamento dopo l'accettazione, sarà addebitato il costo totale dell'ordine.



Trattamento anticalcare optional da inserire al momento dell'ordine € 100
Per il trattamento StarClean considerare un aumento di una settimana dei tempi di consegna



Inquadrare il QR code per collegarsi alla pagina del sito www.samo.it per vedere altre combinazioni di pannelli e vetri



Finitura pannelli in vetro



Finitura pannelli in polystyrene



Profili in alluminio

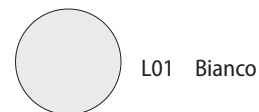

Porta scorrevole a quattro ante, con apertura centrale ad ante scorrevoli, due fisse e due apribili.

Z [cm]	Cod.	A [cm]	B [cm]	C [cm]	[dm³]	[kg]	[n°]	Pannelli	L01 [€]
137-144	B6844	36,5-40,5	35,1	55	159	30	1	TR	564
								ST	581
								JU	564
145-152	B6845	40,1-44,1	35,1	55	174	31	1	TR	587
								ST	605
								JU	585

Tempi di consegna	1-2 settimane	2-3 settimane	3-4 settimane
-------------------	---------------	---------------	---------------

Prodotti Speciali	Misure limite	I [€]	II [€]	III [€]
	H max 200 cm / L max 140 cm - min 60 cm	130	160	200



Inquadrare il QR code per collegarsi alla pagina del sito www.samo.it per vedere altre combinazioni di pannelli e vetri

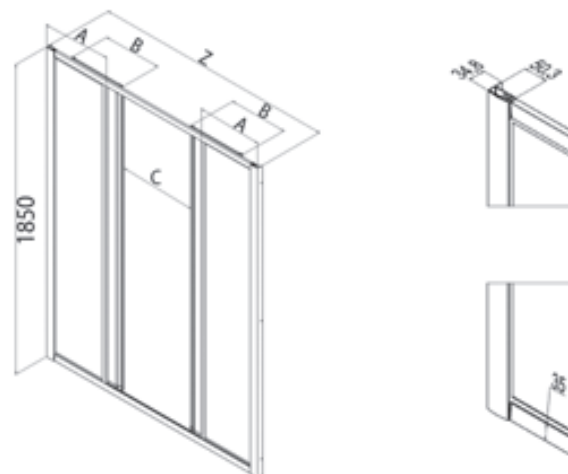

Trattamento anticalcare optional da inserire al momento dell'ordine € 100
Per il trattamento StarClean considerare un aumento di una settimana dei tempi di consegna



H 185 cm.
V 3 mm.

Porta ad un'anta a battente pivot

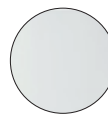

Porta ad un'anta a battente pivot con apertura verso l'esterno.

Finitura pannelli in vetro



-  TR Trasparente
-  ST Stampato

Finitura pannelli in polystyrene

-  JU Juta

Profili in alluminio

-  L01 Bianco

Z [cm]	Cod.	A [cm]	B [cm]	B1 [cm]	C [cm]	 [dm ³]	 [kg]	 [n°]	Pannelli	L01 [€]
68-76	B6835	14,5	58,2	43,8	45	115	17	1	TR	357
									ST	368
									JU	360
77-85	B6836	14,5	67,3	52,8	54	129	19	1	TR	372
									ST	384
									JU	376
86-94	B6837	14,5	76,3	61,8	63	143	20	1	TR	388
									ST	400
									JU	388

Tempi di consegna

1-2 settimane

2-3 settimane

3-4 settimane

Prodotti Speciali	Misure limite	I [€]	II [€]	III [€]
	H max 200 cm / L max 100 cm - min 50 cm	100	125	140



Inquadrare il QR code per collegarsi alla pagina del sito www.samo.it per vedere altre combinazioni di pannelli e vetri

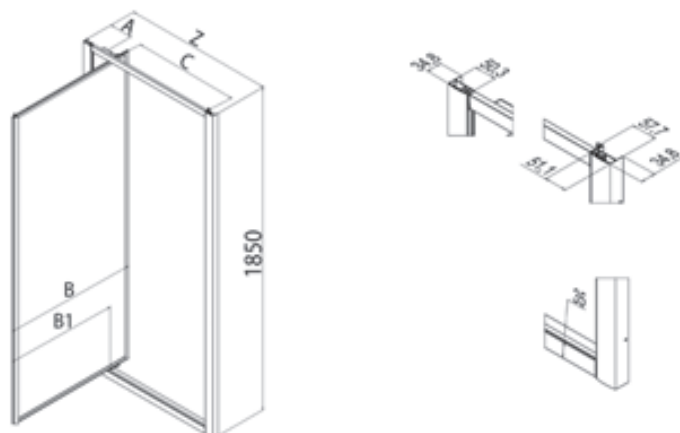



Treatmento anticalcare optional da inserire al momento dell'ordine € 50
Per il trattamento StarClean considerare un aumento di una settimana dei tempi di consegna

H 185 cm.
V 3 mm.

Porta a due ante battenti pivot

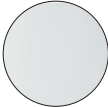

Finitura pannelli in vetro

-  TR Trasparente
-  ST Stampato



Finitura pannelli in polystyrene

-  JU Juta

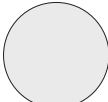
Profili in alluminio

-  L01 Bianco

Porta a due ante a battente pivot, apertura ad ante battenti verso l'esterno.

Z [cm]	Cod.	A [cm]	B [cm]	B1 [cm]	C [cm]	 [dm ³]	 [kg]	 [n°]	Pannelli	L01 [€]
68-76	B6826	10	30	20	45	89	17	1	TR	421
							13	1	ST	434
77-85	B6827	10	35	25	54	99	19	1	JU	423
							14	1	TR	432
							14	1	ST	445
86-94	B6828	10	39	29	63	112	20	1	JU	436
							15	1	TR	445
							15	1	ST	459
95-103	B6829	10	44	34	72	122	22	1	JU	450
							16	1	TR	460
							16	1	ST	474
Tempi di consegna						1-2 settimane	2-3 settimane	3-4 settimane		

Prodotti Speciali	Misure limite	I [€]	II [€]	III [€]
	H max 200 cm / L max 120 cm - min 50 cm	110	150	180



Inquadrare il QR code per collegarsi alla pagina del sito www.samo.it per vedere altre combinazioni di pannelli e vetri

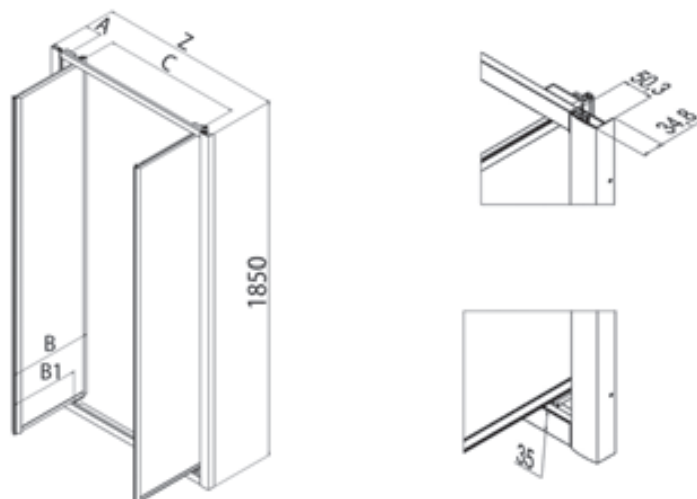

Treatment anticalcare optional da inserire al momento dell'ordine € 50
Per il trattamento StarClean considerare un aumento di una settimana dei tempi di consegna

H 185 cm.
V 3 mm.

Porta a due ante a soffietto



Finitura pannelli in vetro

- TR Trasparente
- ST Stampato

Finitura pannelli in polystirene

- JU Juta

Profili in alluminio

- L01 Bianco

Porta a due ante a soffietto, apertura con ante pieghevoli verso l'interno.

Z [cm]	Cod.	A [cm]	B [cm]	C [cm]	[dm³]	[kg]	[n°]	Pannelli	L01 [€]
68-76	B6831	//	32	49	90	19	1	TR	476
						13	1	ST	491
								JU	478
77-85	B6832	//	36	58	102	21	1	TR	490
						15	1	ST	505
								JU	492
86-94	B6833	//	40	67	113	23	1	TR	505
						16	1	ST	521
								JU	508
95-103	B6834	//	45	76	124	25	1	TR	522
								ST	538
						17	1	JU	525

Tempi di consegna

1-2 settimane

2-3 settimane

3-4 settimane

Prodotti Speciali

Misure limite

I [€]

II [€]

III [€]

H max 200 cm / L max 120 cm - min 50 cm

130

160

200

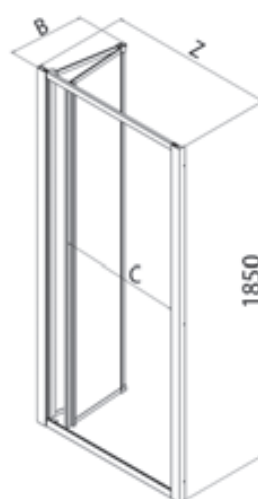

Inquadrare il QR code per collegarsi alla pagina del sito www.samo.it per vedere altre combinazioni di pannelli e vetri



Tattamento anticalcare optional da inserire al momento dell'ordine € 50
Per il trattamento StarClean considerare un aumento di una settimana dei tempi di consegna

H 185 cm.
V 3 mm.

Tondo scorrevole a quattro ante



Finitura pannelli in vetro



Finitura pannelli in polystirene

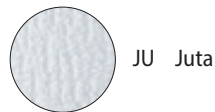

Profili in alluminio

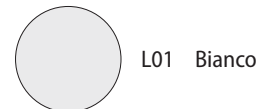

Tondo scorrevole a quattro ante, due fisse laterali e due apribili frontali.

Z [cm]	Cod.	A [cm]	B [cm]	C [cm]	D [cm]	[dm³]	[kg]	[n°]	Pannelli	L01 [€]
71,5-75,5	B6870	34,2-38,2	28	45	34,2-38,2	226	33	2	TR	634
									ST	654
76-80	B6873	22,7-26,7	41	40	22,7-26,7	266	34	2	JU	632
									TR	644
									ST	664
86-90	B6872	32,7-36,7	41	54	32,7-36,7	299	35	2	JU	644
									TR	679
									ST	700
						206	23	2	JU	670

Tempi di consegna	1-2 settimane	2-3 settimane	3-4 settimane
-------------------	---------------	---------------	---------------

Prodotti Speciali	Misure limite	I [€]	II [€]	III [€]
	H max 200 cm / Larghezza max e min richiedere fattibilità	275	//	350

Adatto a piatti doccia arrotondati a raggio NON costante.
Raggio curvatura = 55 cm.
Raggio curvatura = 38 cm. solo per art. B6870.



Inquadrare il QR code per collegarsi alla pagina del sito www.samo.it per vedere altre combinazioni di pannelli e vetri

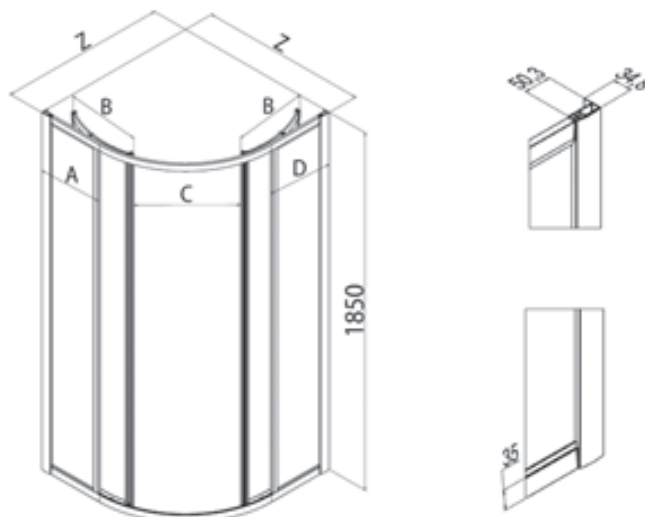

Trattamento anticalcare optional da inserire al momento dell'ordine € 100
Per il trattamento StarClean considerare un aumento di una settimana dei tempi di consegna

H 185 cm.
V 3 mm.

Rettangolare stondato a quattro ante



Finitura pannelli in vetro

- TR Trasparente
- ST Stampato

Finitura pannelli in polystyrene

- JU Juta

Profili in alluminio

- L01 Bianco

Rettangolare stondato scorrevole a quattro ante, due fisse laterali e due apribili frontali.

Z [cm]	Cod.	A [cm]	B [cm]	C [cm]	D [cm]	[dm³]	[kg]	[n°]	Pannelli	L01 [€]
66-70 / 86,5-90,5	B6893	28,7-32,7	28	39	49,2-53,2	229	33	2	TR	658
									ST	679
76-80 / 96,5-100,5	B6895	38,7-42,7	28	39	59,2-63,2	252	35	2	JU	659
									TR	703
									ST	724
						226	20	2	JU	704
Tempi di consegna						1-2 settimane	2-3 settimane	3-4 settimane		
Prodotti Speciali			Misure limite			I [€]	II [€]	III [€]		
			H max 200 cm / Larghezza max e min richiedere fattibilità			275	//	350		

Raggio curvatura = cm. 38

Adatto a piatti doccia arrotondati a raggio NON costante.

* Nota per misura apertura: il box doccia viene fornito con un "fermo" standard per apertura ante, spostandolo o togliendolo si ottiene un'apertura massima di 46 cm.



Inquadrare il QR code per collegarsi alla pagina del sito www.samo.it per vedere altre combinazioni di pannelli e vetri



Trattamento anticalcare optional da inserire al momento dell'ordine € 100
Per il trattamento StarClean considerare un aumento di una settimana dei tempi di consegna

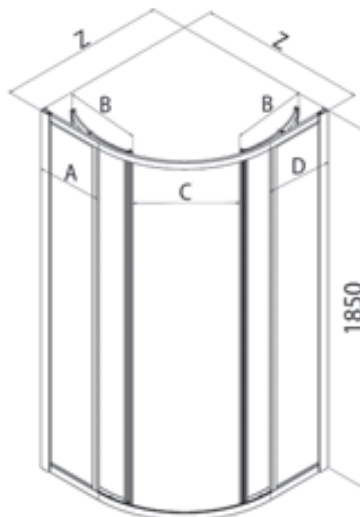

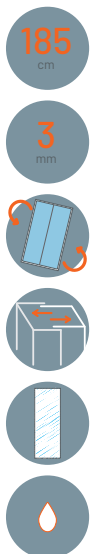

Finitura pannelli in vetro



Finitura pannelli in polystirene



Profili in alluminio

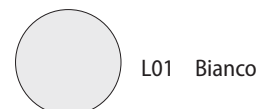

Parete fissa per abbinamenti è possibile formare cabine doccia a due o tre lati, anche misure rettangolari.

Z [cm]	Cod.	A [cm]	B [cm]	C [cm]	[dm³]	[kg]	[n°]	Pannelli	L01 [€]
68-76	B6819	//	//	//	140	15	1	TR	234
								ST	242
								JU	236
77-85	B6820	//	//	//	158	17	1	TR	248
								ST	256
								JU	250
86-94	B6821	//	//	//	175	18	1	TR	268
								ST	277
								JU	270

Tempi di consegna	1-2 settimane	2-3 settimane	3-4 settimane
-------------------	---------------	---------------	---------------

Prodotti Speciali	Misure limite	I [€]	II [€]	III [€]
	H max 200 cm / Larghezza max 120 cm. - min 20 cm.	75	95	115

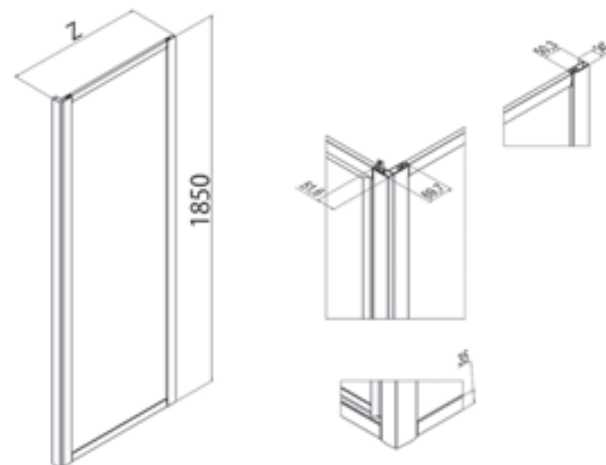

Inquadrare il QR code per collegarsi alla pagina del sito www.samo.it per vedere altre combinazioni di pannelli e vetri

StarClean

Trattamento anticalcare optional da inserire al momento dell'ordine € 50
Per il trattamento StarClean considerare un aumento di una settimana dei tempi di consegna



L01ST



L01TR

Combinazioni possibili

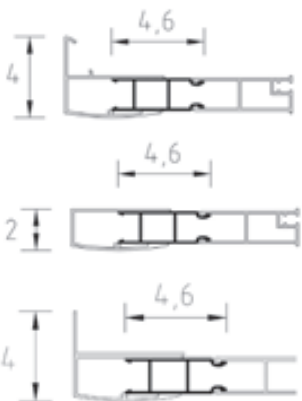

Profilo di compensazione optional

Altezza [cm]	Cod.	Estensibilità [cm]	L01 [€]
185	COM7	0-4	60



Kit per installazione della parete fissa singola o come divisorio

Cod.	L01 [€]
KT6800	131

L'utilizzo del kit diminuisce la misura dell'estensibilità della parete fissa di cm. 2.

Ciao



Finitura pannelli in vetro

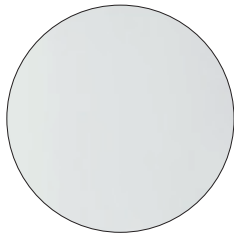

TR
Trasparente

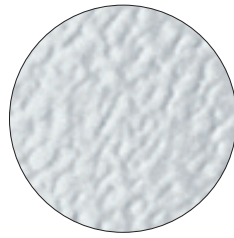

ST
Stampato

Finitura pannelli in polystyrene



SE
Setola

Profili in alluminio

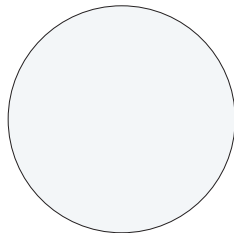

L01
Bianco

Angolo

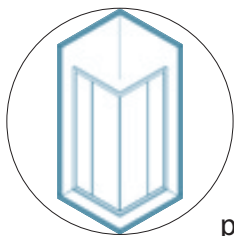

p. 330

Porta

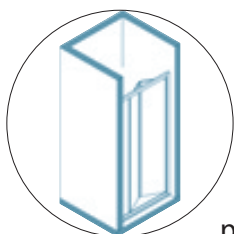

p. 331

Parete fissa

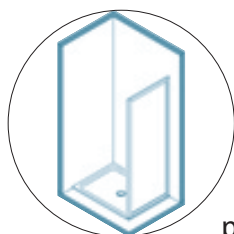

p. 332

Ciao

H 185 cm.
V 3 mm.

Angolo a quattro ante



Finitura pannelli in vetro



Finitura pannelli in polystyrene

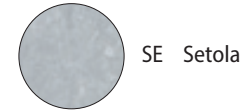

Profili in alluminio

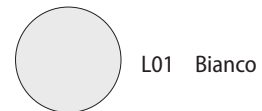

Angolo a quattro ante, apertura ad ante scorrevoli, due fisse e due apribili.

Z [cm]	Cod.	A [cm]	B [cm]	C [cm]	[dm³]	[kg]	[n°]	Pannelli	L01 [€]
64-74	B2601	37,5-39,5	36,4	30-44	122	27	1	TR	374
								ST	387
								SE	317
70-80	B2602	40,5-42,5	39,4	34-48	136	29	1	TR	392
								ST	404
								SE	329
80-90	B2603	45,5-47,5	44,4	42-56	153	30	1	TR	407
								ST	420
								SE	341
64-74/80-90	B2610 *	37,5-39,5	36,4	37-51	156	31	1	TR	391
								ST	404
								SE	329

Tempi di consegna

1-2 settimane

2-3 settimane

3-4 settimane

* Versione rettangolare

Prodotti Speciali: si veda pagina 333

Corretta installazione del profilo ad angolo.

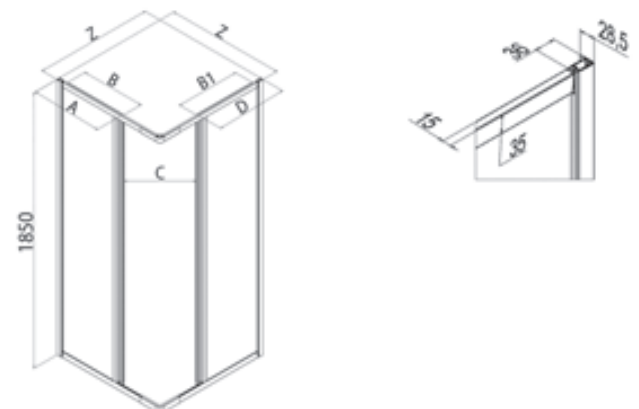

Inquadrare il QR code per collegarsi alla pagina del sito www.samo.it per vedere altre combinazioni di pannelli e vetri



Ciao

H 185 cm.
V 3 mm.

Porta a soffietto

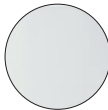

Finitura pannelli in vetro

-  TR Trasparente
-  ST Stampato



Finitura pannelli in polystyrene

-  SE Setola

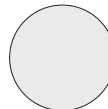
Profili in alluminio

-  L01 Bianco

Cabina doccia a soffietto con apertura verso l'interno.

Z [cm]	Cod.	A [cm]	B [cm]	C [cm]	 [dm³]	 [kg]	 [n°]	Pannelli	L01 [€]
69-73	B2660	14-16	34	51	98	17	1	TR	343
								ST	357
73-77	B2661	14-16	36	55	103	10	1	SE	329
								TR	351
								ST	363
77-81	B2662	14-16	38	59	108	11	1	SE	335
								TR	357
								ST	368
81-85	B2663	14-16	40	63	114	18	1	SE	340
								TR	363
								ST	373
85-89	B2664	14-16	42	67	119	11	1	SE	347
								TR	368
								ST	378
89-93	B2665	14-16	44	71	125	19	1	SE	352
								TR	373
								ST	385
93-97	B2666	14-16	46	75	130	20	1	SE	358
								TR	378
								ST	391
97-101	B2667	14-16	48	79	135	21	1	SE	363
								TR	385
								ST	396
						12	1	SE	373

Prodotti Speciali: si veda pagina 333



Inquadrare il QR code per collegarsi alla pagina del sito www.samo.it per vedere altre combinazioni di pannelli e vetri

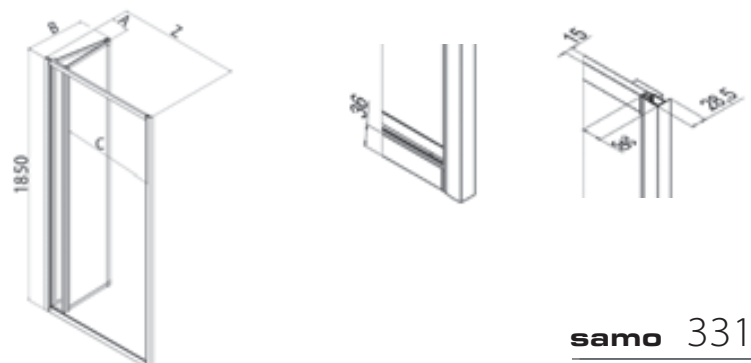

Ciao

H 185 cm.
V 3 mm.

Parete fissa per abbinamenti

Finitura pannelli in vetro



Finitura pannelli in polystyrene

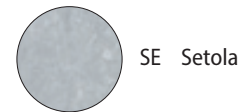

Profili in alluminio

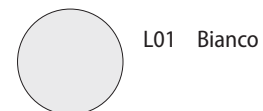
185
cm3
mm

Parete fissa per abbinamenti è possibile formare cabine doccia a due o tre lati, anche misure rettangolari.

Z1 [cm]	Cod.	A [cm]	B [cm]	C [cm]	[dm ³]	[kg]	[n°]	Pannelli	L01 [€]
65-69	B2670	//	//	//	97	12	1	TR	196
						7	1	ST	202
69-73	B2671	//	//	//	99	13	1	SE	180
						8	1	TR	201
						8	1	ST	207
73-77	B2672	//	//	//	102	14	1	SE	184
						9	1	TR	205
						9	1	ST	213
77-81	B2673	//	//	//	107	15	1	SE	187
						9	1	TR	209
						9	1	ST	218
81-85	B2674	//	//	//	112	16	1	SE	192
						9	1	TR	214
						9	1	ST	222
85-89	B2675	//	//	//	118	17	1	SE	196
						10	1	TR	219
						10	1	ST	226
89-93	B2676	//	//	//	123	18	1	SE	200
						10	1	TR	223
						10	1	ST	229
								SE	205

Tempi di consegna

1-2 settimane

2-3 settimane

3-4 settimane

Combinazioni possibili



Inquadrare il QR code per collegarsi alla pagina del sito www.samo.it per vedere altre combinazioni di pannelli e vetri

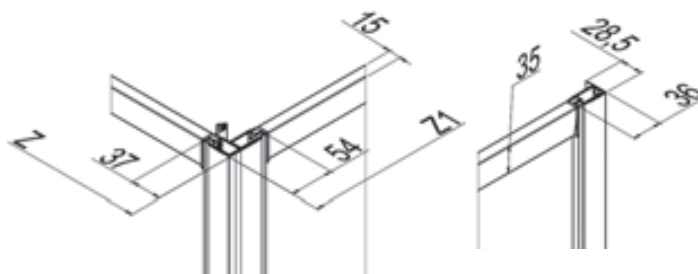
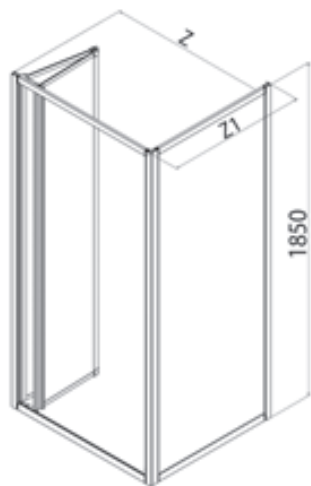

Corretta installazione del profilo ad angolo.

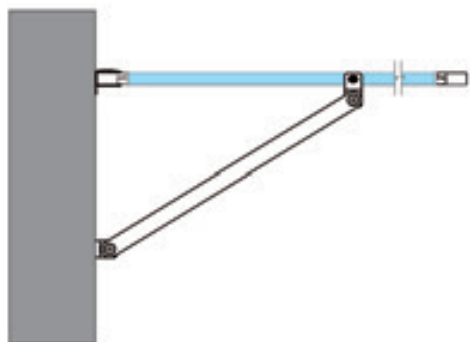

Kit per installazione della parete fissa singola o come divisorio

Cod.	L01 [€]
KT2600	94

L'utilizzo del kit diminuisce la misura dell'estensibilità della parete fissa di cm. 2.

Parete fissa per abbinamenti

Prodotti Speciali	Misure limite	I [€]	II [€]	III [€]
Vetro	H max 185 cm / L max 120 cm - min 20 cm	55	65	75
Polystyrene	H max 185 cm / L max 100 cm - min 20 cm	55	65	75

Modulo di richiesta disponibile on-line sul sito: www.samo.it/it/prodotti-speciali - In caso di annullamento dopo l'accettazione, sarà addebitato il costo totale dell'ordine.

Angolo a quattro ante

Prodotti Speciali	Misure limite	I [€]	II [€]	III [€]
Vetro	H max 185 cm / L max 100 cm - min 60 cm	70	85	105

Modulo di richiesta disponibile on-line sul sito: www.samo.it/it/prodotti-speciali - In caso di annullamento dopo l'accettazione, sarà addebitato il costo totale dell'ordine.

Porta a soffietto

Prodotti Speciali	Misure limite	I [€]	II [€]	III [€]
Vetro	H max 185 cm / L max 110 cm - min 50 cm	70	85	105

Modulo di richiesta disponibile on-line sul sito: www.samo.it/it/prodotti-speciali - In caso di annullamento dopo l'accettazione, sarà addebitato il costo totale dell'ordine.

Pareti vasca



Finitura pannelli in vetro

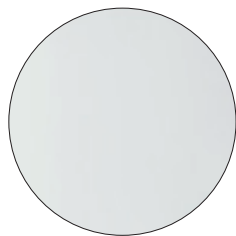

TR
Trasparente

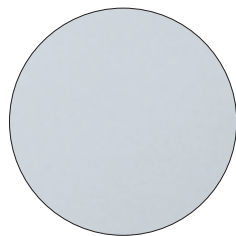

RS
Satinato

Finitura pannelli in polystirene

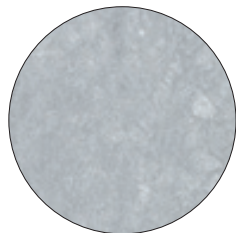

SE
Setola

Profili in alluminio

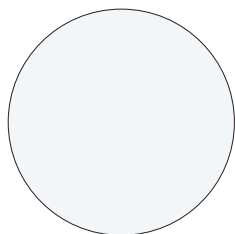

L01
Bianco



ULU
Brillantato cromo

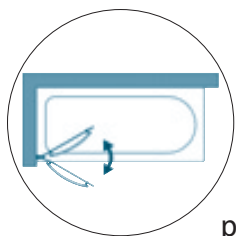

p. 336



p. 337

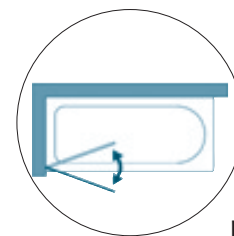

p. 338

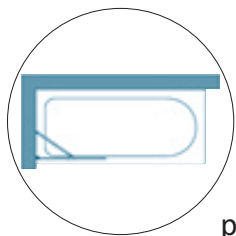

p. 339

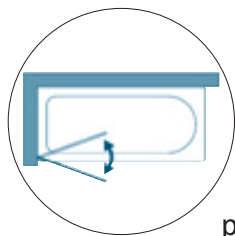

p. 340

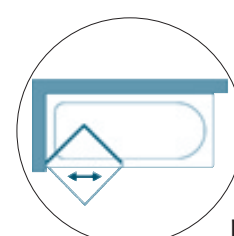

p. 341

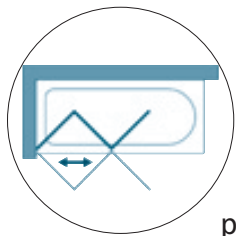

p. 342

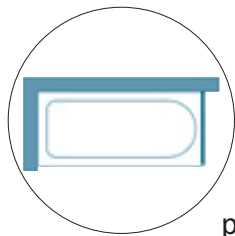

p. 343

B1670-B1672

H 140 cm.
V 6 mm.

Parete vasca

Finitura pannelli



Profili in alluminio

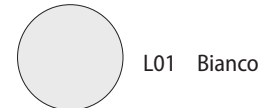

Parete per vasca ad un'anta con apertura verso l'interno e verso l'esterno

Z [cm]	Cod.	A [cm]	B [cm]	[dm ³]	[kg]	[n°]	Pannelli	L01 [€]	ULU [€]
70-72	B1670	//	65,5	82	18	1	TR	341	440
80-82	B1672	//	75,5	90	18	1	TR	357	462
Tempi di consegna				1-2 settimane		2-3 settimane		3-4 settimane	

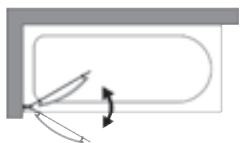

Prodotti Speciali: si veda pagina 344

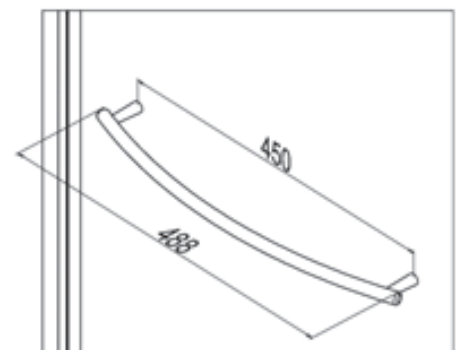
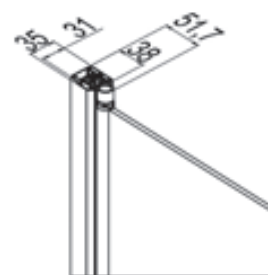
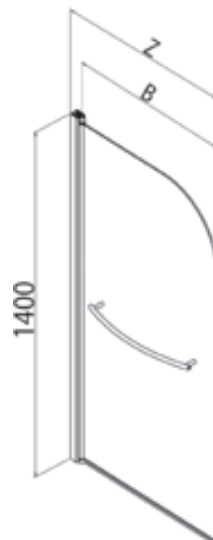

Tattamento anticalcare optional da inserire al momento dell'ordine € 50
Per il trattamento StarClean considerare un aumento di una settimana dei tempi di consegna

B1696-B1697

H 140 cm.
V 6 mm.

Parete vasca

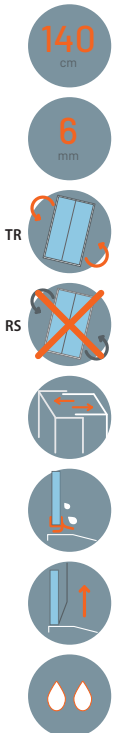

Finitura pannelli

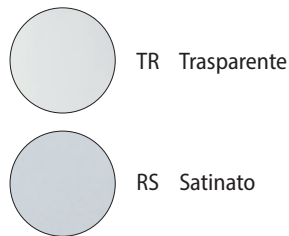

Profili in alluminio



Anta finale in vetro arrotondata con apertura verso l'interno e verso l'esterno.

Z [cm]	Cod.	A [cm]	B [cm]	[dm³]	[kg]	[n°]	Pannelli	L01 [€]	ULU [€]
105-107	B1696	53,5	48	67	26	1	TR	469	584
							RS	506	632
120-122	B1697	61	55,5	74	28	1	TR	493	616
							RS	533	666

Tempi di consegna	1-2 settimane	2-3 settimane	3-4 settimane
-------------------	---------------	---------------	---------------

Per finitura RS specificare se versione destra (DX) o versione sinistra (SX).



Prodotti Speciali: si veda pagina 344

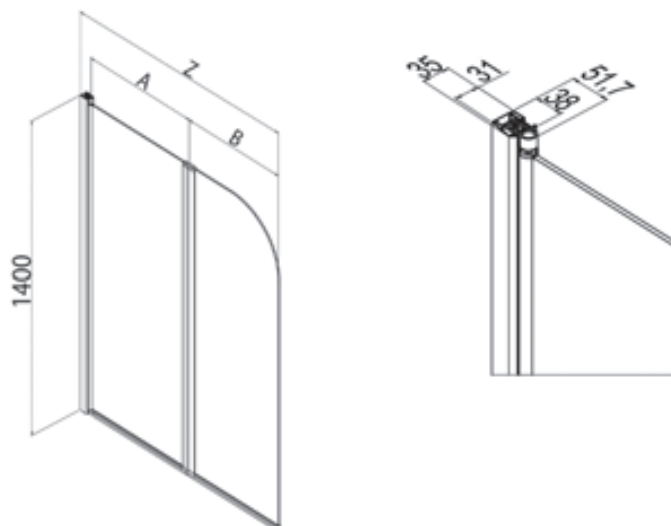

Pareti vasca



Treatment anticalcare optional da inserire al momento dell'ordine € 50
Per il trattamento StarClean considerare un aumento di una settimana dei tempi di consegna

B1685-89-90-95-98-99

H 140/160 cm.
V 6 mm.

Parete vasca



Finitura pannelli

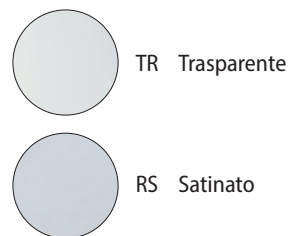

Profili in alluminio



Anta in vetro con apertura verso l'interno e verso l'esterno.
Vetro squadrato B1685-1690-1695, vetro stonato B1689-1698-1699, B1695 e B1699 sono H. 160 cm.

Z [cm]	Cod.	A [cm]	B [cm]	[dm ³]	[kg]	[n°]	Pannelli	L01 [€]	ULU [€]
75-77	B1689	//	70,5	78	20	1	TR	302	359
							RS	326	391
85-87	B1698	//	80,5	95	22	1	TR	329	393
							RS	353	426
85-87	B1699	//	80,5	108	25	1	TR	347	414
							RS	374	449
75-77	B1685	//	70,5	78	20	1	TR	302	359
							RS	326	391
85-87	B1690	//	80,5	95	22	1	TR	329	393
							RS	353	426
85-87	B1695	//	80,5	108	25	1	TR	347	414
							RS	374	449



Per finitura RS specificare se versione destra (DX) o versione sinistra (SX).

Prodotti Speciali: si veda pagina 344

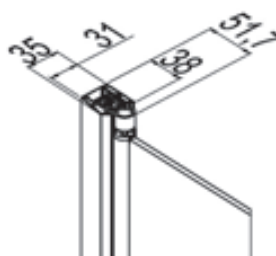

B1689 = H. 140 cm.
B1698 = H. 140 cm.
B1699 = H. 160 cm.

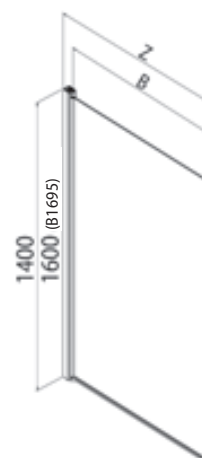

B1685 = H. 140 cm.
B1690 = H. 140 cm.
B1695 = H. 160 cm.



Trattamento anticalcare optional da inserire al momento dell'ordine € 50
Per il trattamento StarClean considerare un aumento di una settimana dei tempi di consegna

B1650-55-60-65

H 140 cm.
V 6 mm.

Parete vasca

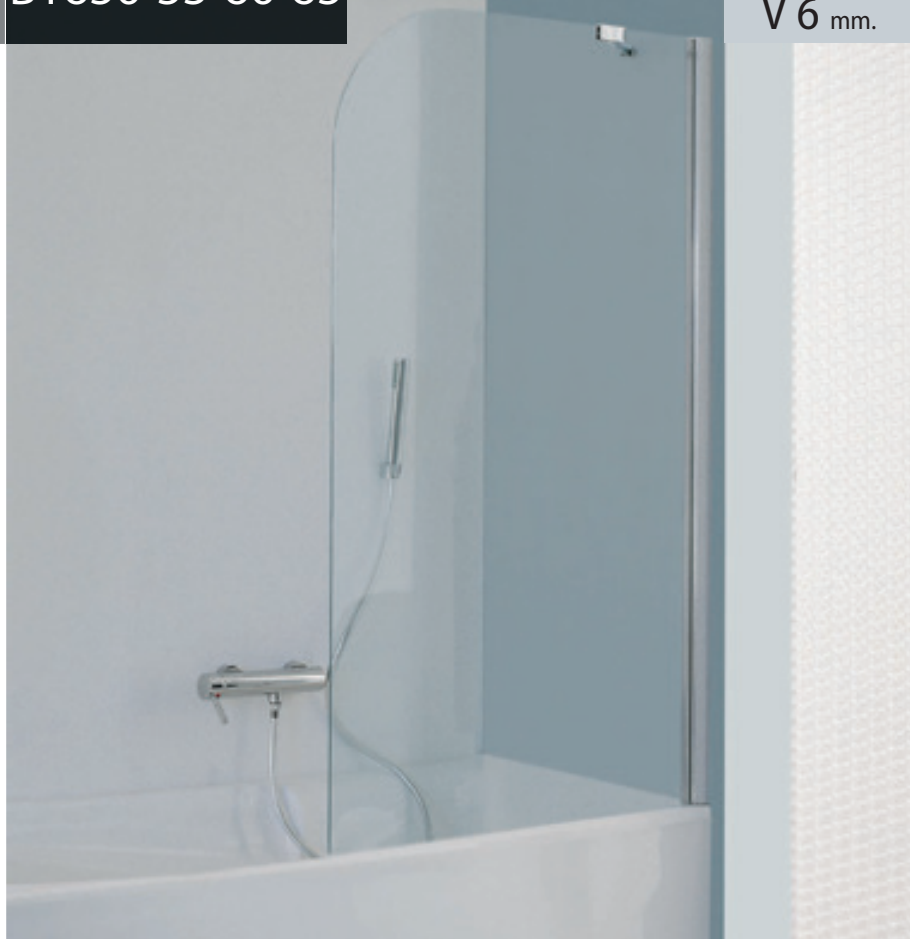

Finitura pannelli

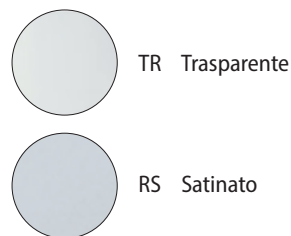

Profili in alluminio



Anta fissa in vetro squadrata e/o arrotondata.
Vetro squadrato B1655-1665, vetro stonato B1650 - B1660 sono H. 140 cm. Zanca in dotazione (RIC2371)

Z [cm]	Cod.	A [cm]	B [cm]	[dm ³]	[kg]	[n°]	Pannelli	L01 [€]	ULU [€]
75-77	B1650	70,5-72,5	//	87	24	1	TR	256	322
							RS	283	352
85-87	B1660	80,5-82,5	//	91	26	1	TR	275	342
							RS	306	382
75-77	B1655	70,5-72,5	//	87	24	1	TR	256	322
							RS	283	352
85-87	B1665	80,5-82,5	//	91	26	1	TR	275	342
							RS	306	382

Tempi di consegna

1-2 settimane

2-3 settimane

3-4 settimane



SX



DX

Per finitura RS specificare se versione destra (DX) o versione sinistra (SX).

Prodotti Speciali: si veda pagina 344

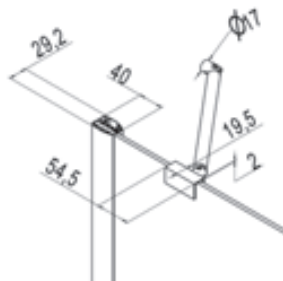

B1650
B1660



B1655
B1665

Pareti vasca

Optional

RIC2371

Zanca di sostegno optional, da richiedere al momento dell'ordine

L01 [€]

51

ULU [€]

57



Trattamento anticalcare optional da inserire al momento dell'ordine € 50
Per il trattamento StarClean considerare un aumento di una settimana dei tempi di consegna

B1384

H 135 cm.
V 3 mm.

Parete pieghevole a tre ante per vasca

Finitura pannelli in vetro



Finitura pannelli in polystyrene



Profili in alluminio

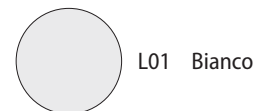

Parete pieghevole a tre ante per vasca con apertura verso l'interno e verso l'esterno.
Il verso di apertura si stabilisce durante l'installazione.

Z [cm]	Cod.	A [cm]	B [cm]	D [cm]	[dm³]	[kg]	[n°]	Pannelli	L01 [€]
137-139	B1384	44,9	43,1	44	66	26	1	TR	351
						14	1	SE	305

Tempi di consegna	1-2 settimane	2-3 settimane	3-4 settimane
-------------------	---------------	---------------	---------------

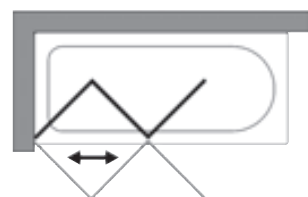

Prodotti Speciali: si veda pagina 344

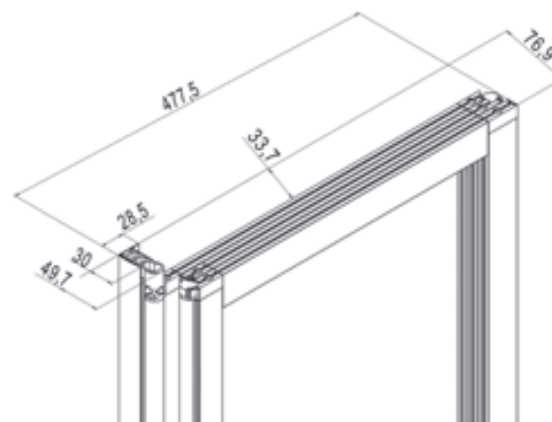
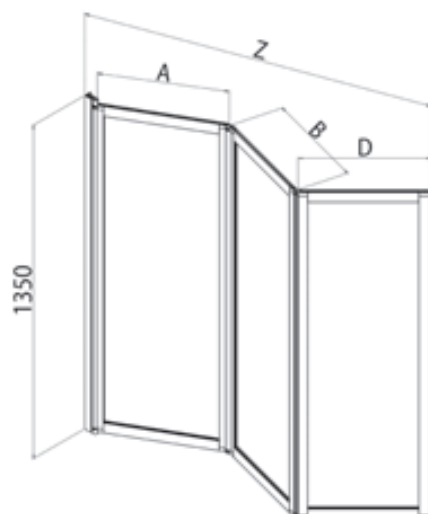

B1385

H 135 cm.
V 3 mm.

Parete pieghevole a due ante per vasca

Finitura pannelli in vetro



Finitura pannelli in polystyrene

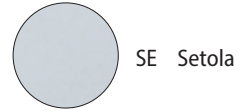

Profili in alluminio

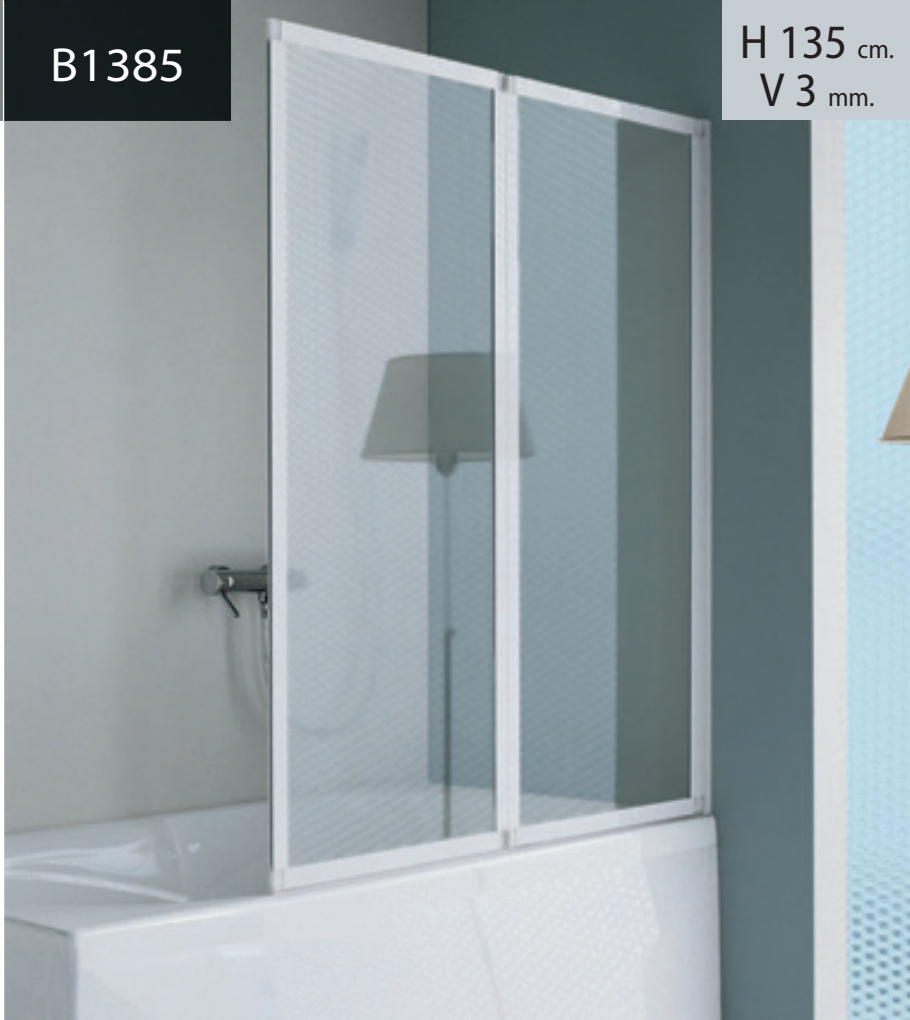
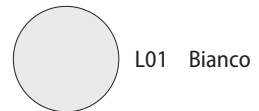

Parete pieghevole a due ante per vasca con apertura verso l'interno e verso l'esterno. Il verso di apertura si stabilisce durante l'installazione.

Z [cm]	Cod.	B [cm]	D [cm]	E [cm]	[dm³]	[kg]	[n°]	Pannelli	L01 [€]
126-128	B1385	61	60	//	72	17	1	TR	297
						10	1	SE	257

Tempi di consegna	1-2 settimane	2-3 settimane	3-4 settimane
-------------------	---------------	---------------	---------------



Prodotti Speciali: si veda pagina 344

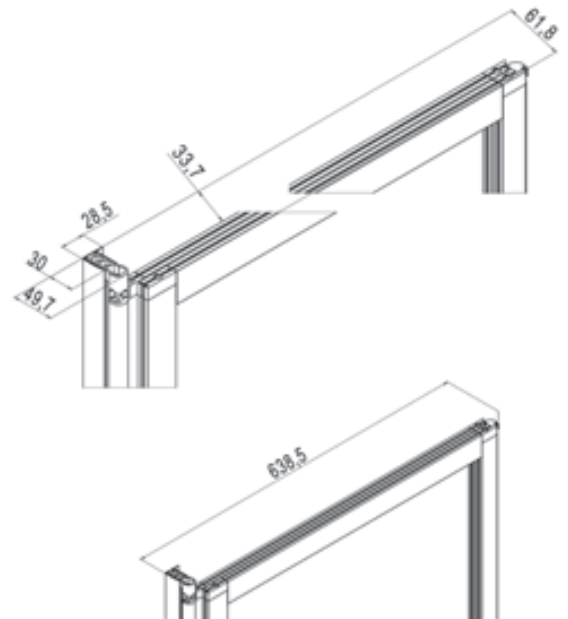
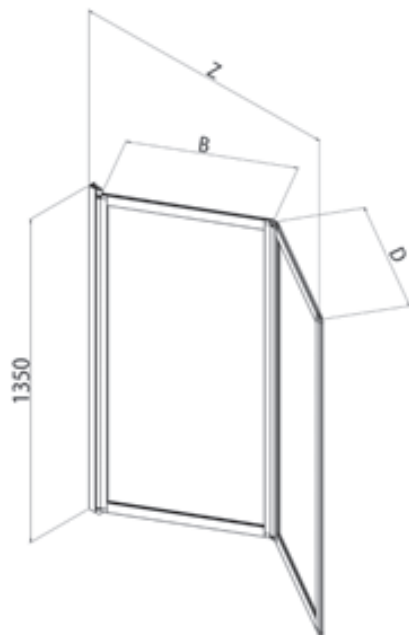

Pareti vasca

B1382

H 135 cm.
V 3 mm.

Parete per vasca ad un'anta battente

Finitura pannelli in vetro



Finitura pannelli in polystyrene



Profili in alluminio

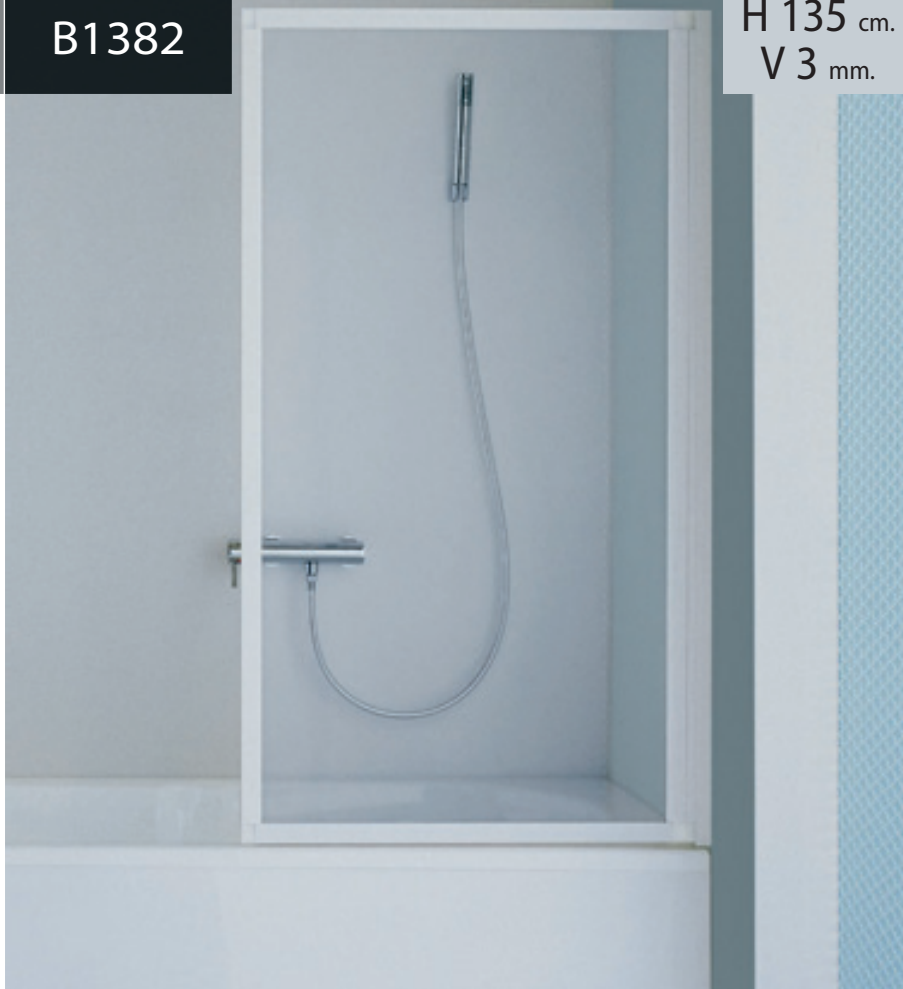
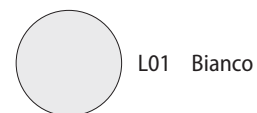

Anta fissa con apertura verso l'interno e verso l'esterno.

Z [cm]	Cod.	A [cm]	B [cm]	D [cm]	[dm³]	[kg]	[n°]	Pannelli	L01 [€]
75-77	B1382	//	70	//	81	14	1	TR	221
						6	1	SE	189
Tempi di consegna					1-2 settimane		2-3 settimane		3-4 settimane

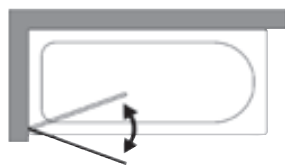

Prodotti Speciali: si veda pagina 344

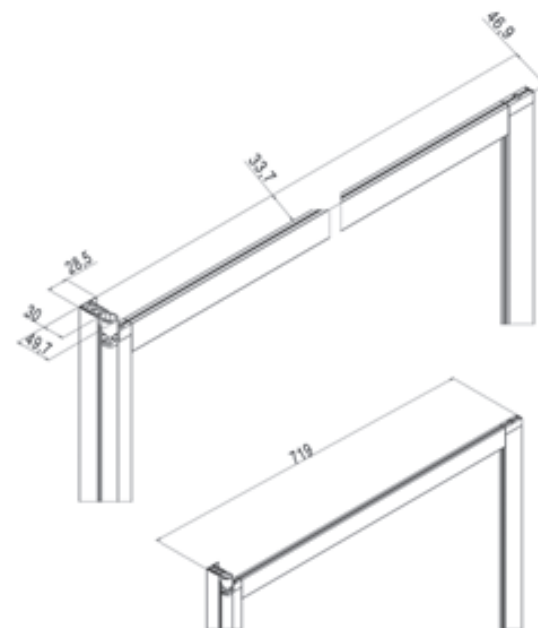
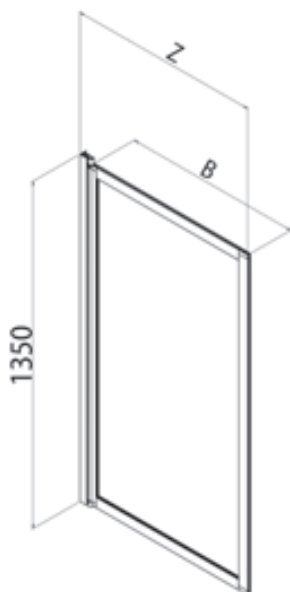

B1390-91-92-93

H 135 cm.
V 3 mm.

Parete fissa solo per abbinamenti

Finitura pannelli in vetro



Finitura pannelli in polystyrene



Profili in alluminio

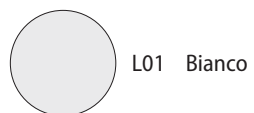

Parete fissa per vasca, sono possibili combinazioni a due lati.

Z [cm]	Cod.	A [cm]	B [cm]	D [cm]	[dm³]	[kg]	[n°]	Pannelli	L01 [€]
63-67	B1393	//	//	//	65	13	1	TR	234
						6	1	SE	205
68-72	B1390	//	//	//	70	13	1	TR	236
						6	1	SE	207
73-77	B1391	//	//	//	74	13	1	TR	239
						7	1	SE	212
78-82	B1392	//	//	//	75	13	1	TR	241
						7	1	SE	216

Tempi di consegna

1-2 settimane

2-3 settimane

3-4 settimane



Non installabile singolarmente o come divisorio.
Prodotti Speciali: si veda pagina 344
Possibili combinazioni:

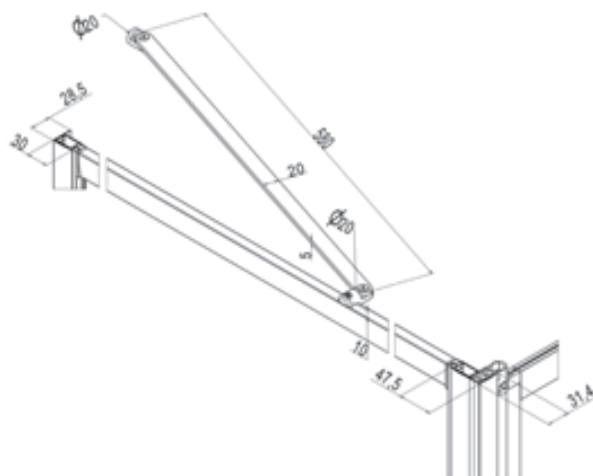
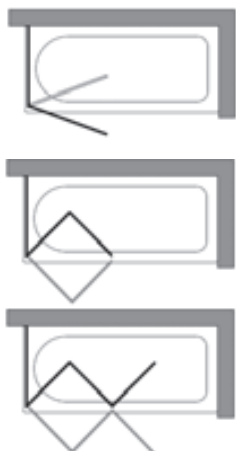

Pareti vasca

B1670-B1672

Prodotti Speciali	Misure limite	I [€]	II [€]	III [€]
	H max 160 cm - min 120 cm / L max 100 cm - min 35 cm	70	85	105

Modulo di richiesta disponibile on-line sul sito: www.samo.it/it/prodotti-speciali - In caso di annullamento dopo l'accettazione, sarà addebitato il costo totale dell'ordine.

B1696-B1697

Prodotti Speciali	Misure limite	I [€]	II [€]	III [€]
	H max 160 cm - min 120 cm / L max 140 cm - min 70 cm	70	85	105

Modulo di richiesta disponibile on-line sul sito: www.samo.it/it/prodotti-speciali - In caso di annullamento dopo l'accettazione, sarà addebitato il costo totale dell'ordine.

B1685-B1689-B1690-B1695-B1698-B1699

Prodotti Speciali	Misure limite	I [€]	II [€]	III [€]
	H max 160 cm - min 120 cm / L max 100 cm - min 35 cm	70	85	105

Modulo di richiesta disponibile on-line sul sito: www.samo.it/it/prodotti-speciali - In caso di annullamento dopo l'accettazione, sarà addebitato il costo totale dell'ordine.

B1650-B1655-B1660-B1665

Prodotti Speciali	Misure limite	I [€]	II [€]	III [€]
	H max 160 cm - min 120 cm / L max 100 cm - min 35 cm	70	85	105

Modulo di richiesta disponibile on-line sul sito: www.samo.it/it/prodotti-speciali - In caso di annullamento dopo l'accettazione, sarà addebitato il costo totale dell'ordine.

B1384

Prodotti Speciali	Misure limite	I [€]	II [€]	III [€]
	H max 160 cm - min 120 cm / L max 145 cm - min 60 cm	70	85	105

Modulo di richiesta disponibile on-line sul sito: www.samo.it/it/prodotti-speciali - In caso di annullamento dopo l'accettazione, sarà addebitato il costo totale dell'ordine.

B1385

Prodotti Speciali	Misure limite	I [€]	II [€]	III [€]
	H max 160 cm - min 120 cm / L max 135 cm - min 50 cm	70	85	105

Modulo di richiesta disponibile on-line sul sito: www.samo.it/it/prodotti-speciali - In caso di annullamento dopo l'accettazione, sarà addebitato il costo totale dell'ordine.

B1382

Prodotti Speciali	Misure limite	I [€]	II [€]	III [€]
	H max 160 cm - min 120 cm / L max 90 cm - min 25 cm	70	85	105

Modulo di richiesta disponibile on-line sul sito: www.samo.it/it/prodotti-speciali - In caso di annullamento dopo l'accettazione, sarà addebitato il costo totale dell'ordine.

B1390-B1391-B1932-B1933

Prodotti Speciali	Misure limite	I [€]	II [€]	III [€]
	H max 160 cm - min 120 cm / L max 100 cm - min 20 cm	70	85	105

Modulo di richiesta disponibile on-line sul sito: www.samo.it/it/prodotti-speciali - In caso di annullamento dopo l'accettazione, sarà addebitato il costo totale dell'ordine.



B1384L01SE



B1385L01SE



B1382L01SE

Prodotti speciali



Come comporre il codice di un prodotto speciale

Z [cm]	Cod.	Z1 [cm]	A [cm]	B [cm]	C [cm]	 [dm³]	 [kg]	 [n°]	L01 [€]
64-66,5	B3750	62,2-68,7	//	//	//	99	29	1	
									TR
									AS
									RF

B S 3750 L01 TR

Per la creazione del codice del prodotto speciale bisogna aggiungere la lettera **S** tra la lettera **B** (Tipologia di prodotto) e il numero di Serie del modello-misura

Standard	Tipo (Livello)	Forme SPECIALI			
 ALTEZZA standard e LARGHEZZA standard di riferimento	I	 ALTEZZA inferiore	 ALTEZZA superiore	 LARGHEZZA inferiore	 LARGHEZZA superiore
	II	 ALTEZZA inferiore LARGHEZZA inferiore	 ALTEZZA superiore LARGHEZZA inferiore	 ALTEZZA inferiore LARGHEZZA superiore	 ALTEZZA superiore LARGHEZZA superiore
	III	 VETRO ritagliato	 VETRO sopra muretto	 VETRO sagomato	 LARGHEZZA ante personalizzata
	IIII	SOLUZIONI DIVERSE da quelle contemplate nei livelli I, II, III: si veda la sezione dedicata da pag. 352 a pag. 363 CONTATTARE UFFICIO CLIENTI per avere la fattibilità e il prezzo			

LARGHEZZE INTERMEDIE: sommare al prezzo della misura superiore.

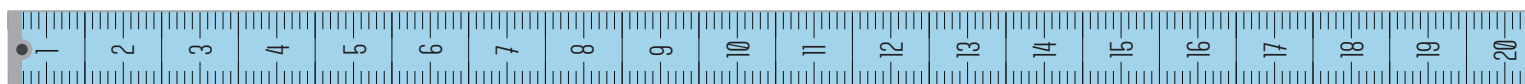

Prodotti speciali

Come prendere le misure dello spazio destinato a ricevere la cabina doccia

VERIFICA DELLA MESSA IN BOLLA ORIZZONTALE

Controllo del livello del piatto, vasca o piastrelle
(in caso di montaggio a filo pavimento)

- _ "0" (zero) indica il punto più alto
- _ "-" (meno) indica la deviazione verso il basso

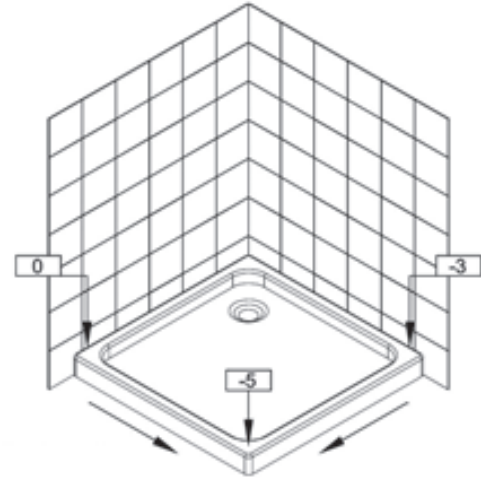

Pendenza a 5 mm.

Pendenza a 3 mm.

VERIFICA DELLA MESSA IN BOLLA VERTICALE

Inclinazione della parete muraria

- _ "0" (zero) il punto zero si trova sempre a terra sul piatto doccia o sul pavimento
- _ "+" (più) indica l'inclinazione della parete verso l'esterno, riferito all'altezza della Cabina.
- _ "-" (meno) indica l'inclinazione della parete verso l'interno, riferito all'altezza della cabina.

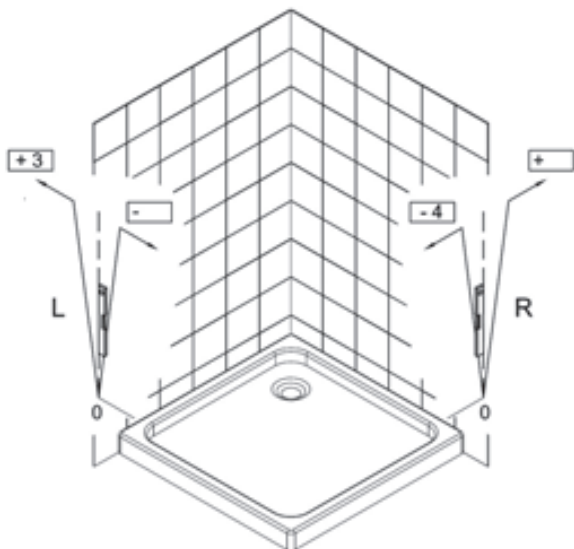

Simbolo per il livello verticale

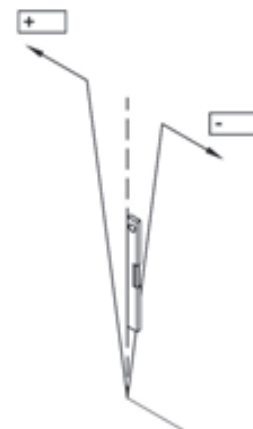

Prodotti speciali

PRESA MISURA DELLO SPAZIO DESTINATO A RICEVERE LA CABINA DOCCIA

MISURE: attenzione, le misure richieste sono sempre relative allo spazio doccia, NON alle misure della cabina doccia

- _ Piatto doccia misure esterne ed interne.
- _ In caso di montaggio a filo pavimento segnalare le dimensioni delle fughe.
- _ Contrassegnare la modalità di montaggio desiderata.

Montaggio su piatto doccia

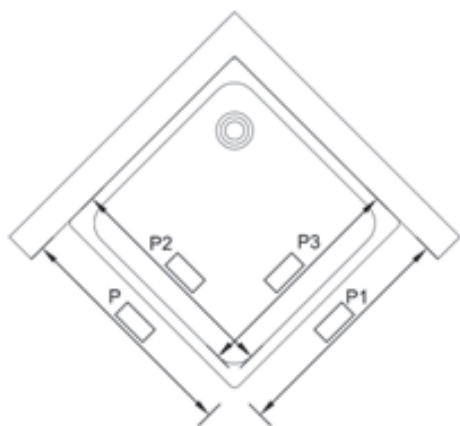

Montaggio a pavimento

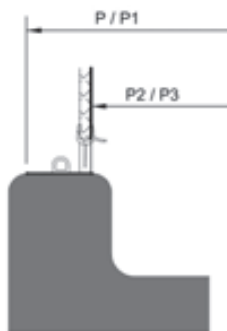
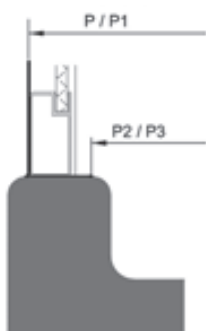
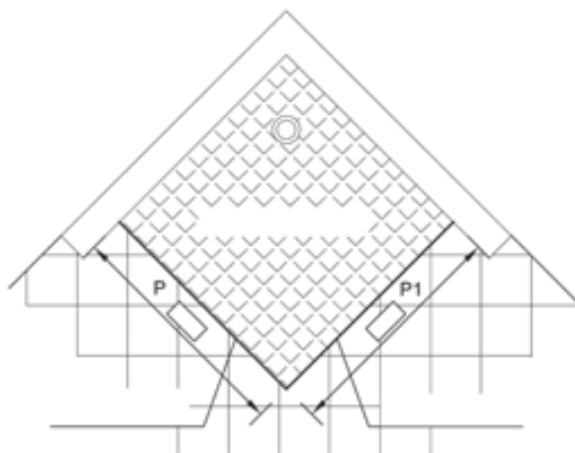

TAGLI OBLIQUI E SITUAZIONI MANSARDATE

In questi casi è sempre necessario rilevare l'angolo. A questo scopo collocare il goniometro, appoggiandolo sui due lati, sul muro verticale e sulla pendenza ed annotare semplicemente l'angolo che ne consegue.

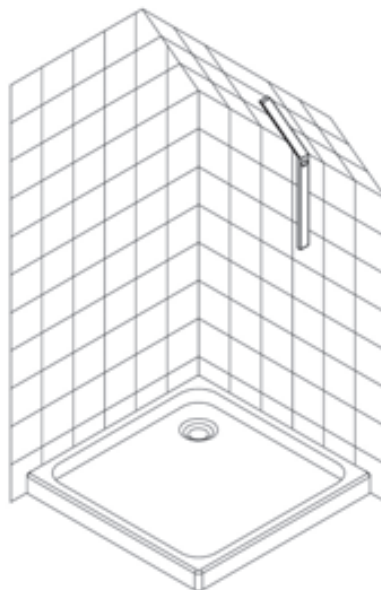

Prodotti speciali

MODULO DI RICHIESTA disponibile on-line sul sito: www.samo.it/it/prodotti-speciali

G01a Data: _____ Offerta: Ordine: Cliente: _____

Ticket: _____ Ref. Cliente: : _____ Firma Cliente: _____

Serie: _____ Modello: : _____ Colore profilo: _____

Rif. Cantiere: _____ Piano terra/ piano 1°/.....) Vetro: _____ StarClean: SI NO

NOTE: _____

N.B. La conferma definitiva del prodotto sarà a cura dell'Ufficio Clienti Samo. Le misure vanno indicate in mm. Il modulo va compilato in ogni sua parte.

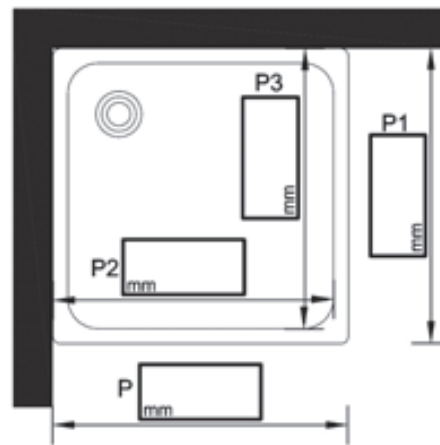
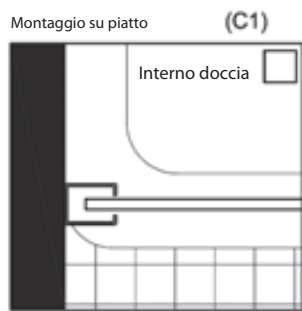

H totale
mm _____

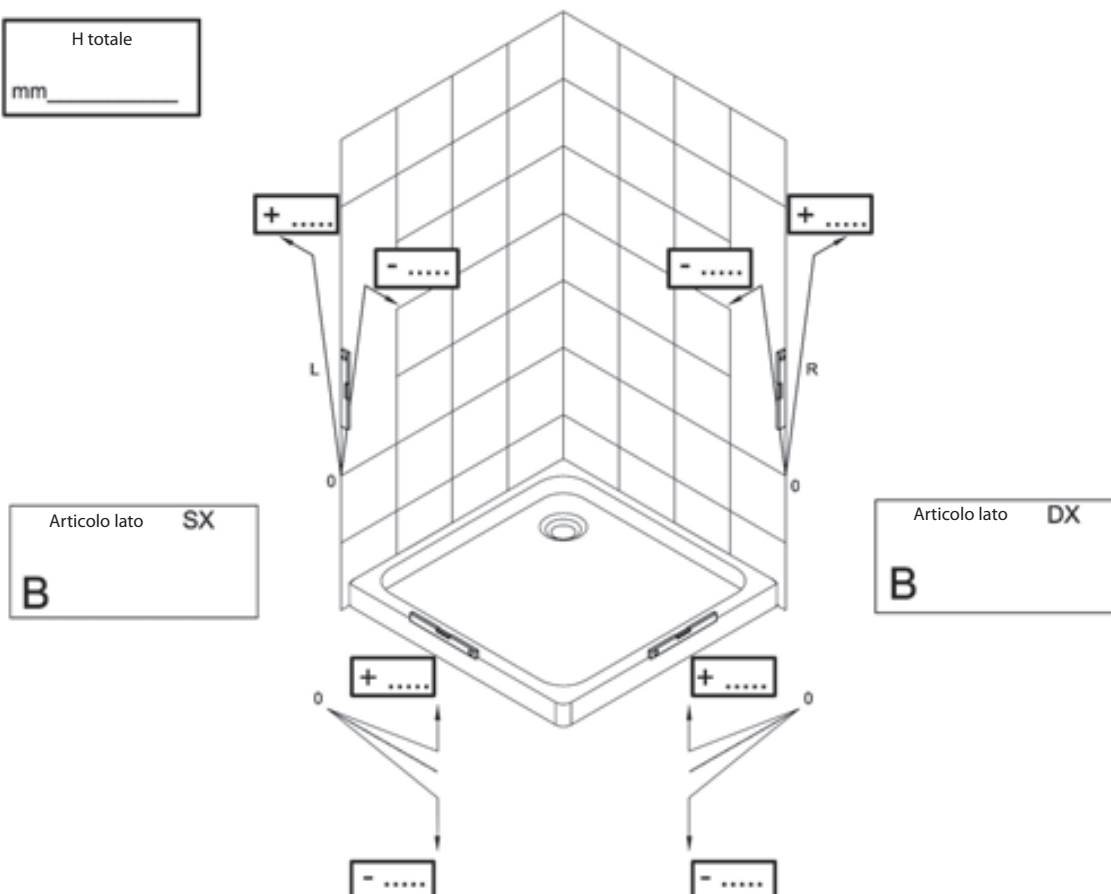

Prodotti speciali

MODULO DI RICHIESTA disponibile on-line sul sito: www.samo.it/it/prodotti-speciali

G01b

Data: _____ Offerta: Ordine: Cliente: _____

Ticket: _____ Ref. Cliente: : _____ Firma Cliente: _____

Serie: _____ Modello: : _____ Colore profilo: _____

Rif. Cantiere: _____ Piano terra/ piano 1°/.....) Vetro: _____ StarClean: SI NO

NOTE: _____

N.B. La conferma definitiva del prodotto sarà a cura dell'Ufficio Clienti Samo. Le misure vanno indicate in mm. Il modulo va compilato in ogni sua parte.

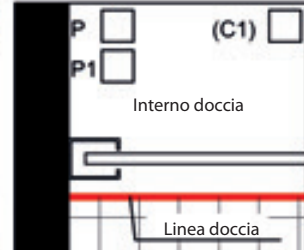
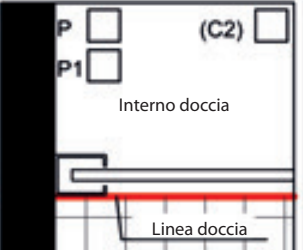
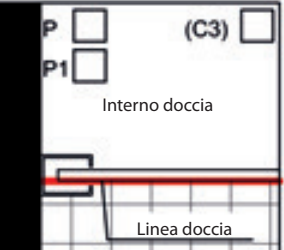
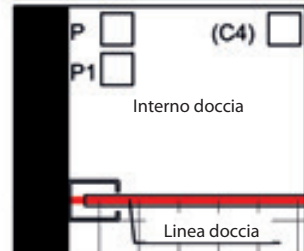
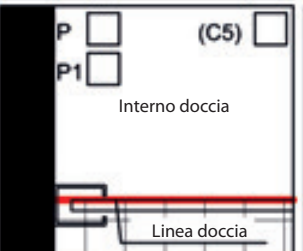
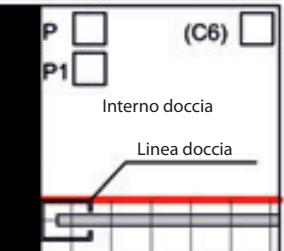

P <input type="checkbox"/> (C1) <input type="checkbox"/> P1 <input type="checkbox"/> Interno doccia  Linea doccia	P <input type="checkbox"/> (C2) <input type="checkbox"/> P1 <input type="checkbox"/> Interno doccia  Linea doccia	P <input type="checkbox"/> (C3) <input type="checkbox"/> P1 <input type="checkbox"/> Interno doccia  Linea doccia
P <input type="checkbox"/> (C4) <input type="checkbox"/> P1 <input type="checkbox"/> Interno doccia  Linea doccia	P <input type="checkbox"/> (C5) <input type="checkbox"/> P1 <input type="checkbox"/> Interno doccia  Linea doccia	P <input type="checkbox"/> (C6) <input type="checkbox"/> P1 <input type="checkbox"/> Interno doccia  Linea doccia

H totale
 mm _____

Articolo lato SX
B

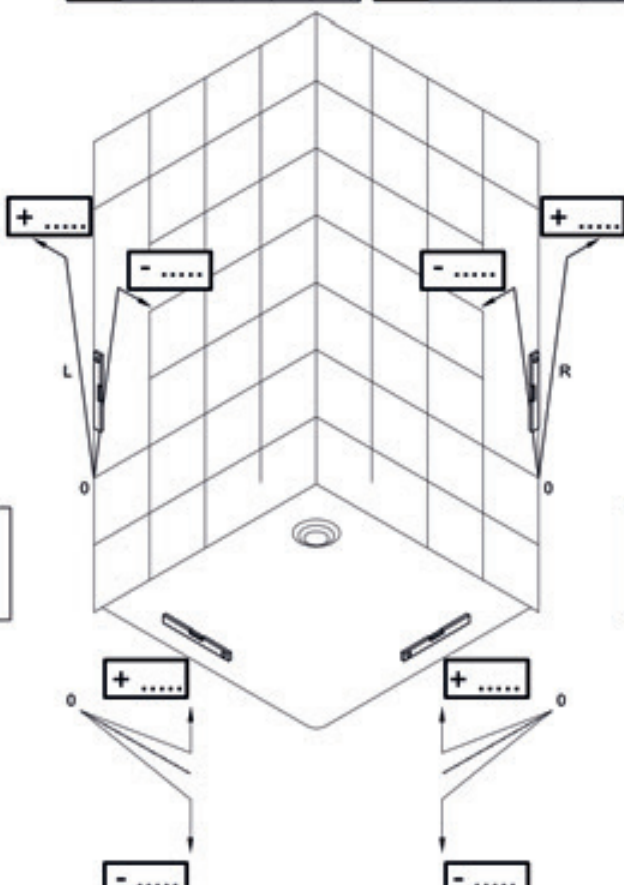

Articolo lato DX
B

Prodotti speciali

samo 351

Prodotti speciali

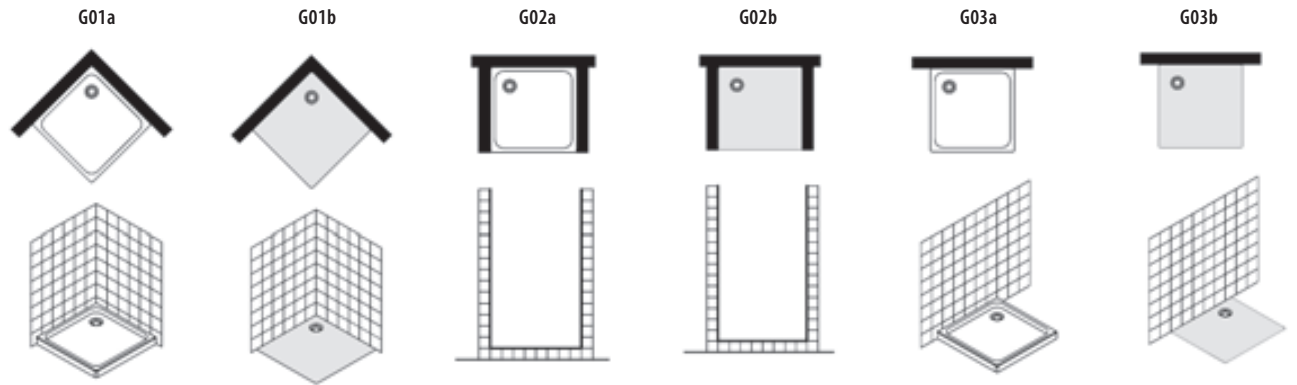

OPEN						
P058-9_B4751-57	✓	✓				
P058-9_B4781-87	✓	✓				
P058-9_B478X-Y	✓	✓				
P060-1_B4745-47	✓	✓				
P062-3_B4771-73	✓	✓				
P064-5_B4600-04	✓	✓	✓	✓		
P066-7_B461X	✓	✓				
P068-9_B4650-53	✓	✓				
P070-1_B4051-57	✓	✓				
P070-1_B4081-87	✓	✓				
P072-3_B4001-09	✓	✓				
P072-3_B4091-99	✓	✓				
P074-5_B4073-77					✓	✓
P076-7_B4040-41 B4045-49	✓	✓			✓	✓

ZENITH						
P090-1_B9111-9115	✓	✓				
P092-3_B9101-9107			✓	✓		
P094-5_B9150-3 B9121-7	✓	✓				
P096-7_B9182-9187	✓	✓	✓	✓		
P098-9_B9170-9173	✓	✓				

GRAND POLARIS						
P110-1_B3705-3715	✓	✓				
P112-3_B3750-3760			✓	✓		
P114-5_B3730-3746	✓	✓				

ACRUX						
P126-7_B8816-8833	✓	✓				
P128-9_B8880-90 B8892-97	✓	✓				
P130-1_B8812-8846	✓	✓	✓	✓	✓	✓
P132-3_B8852-8856	✓	✓	✓	✓	✓	✓
P134-5_B8801-8807	✓	✓	✓	✓		
P136-7_B8822-8827	✓	✓			✓	✓

EUROPA SP						
P146-7_B7916-7923	✓	✓			✓	✓
P148-9_B7980-7991	✓	✓	✓	✓	✓	✓
P150-1_B7970-7977	✓	✓	✓	✓		
P152-3_B7944-7948	✓	✓	✓	✓	✓	✓
P154-5_B7924-7929	✓	✓			✓	✓

Prodotti speciali

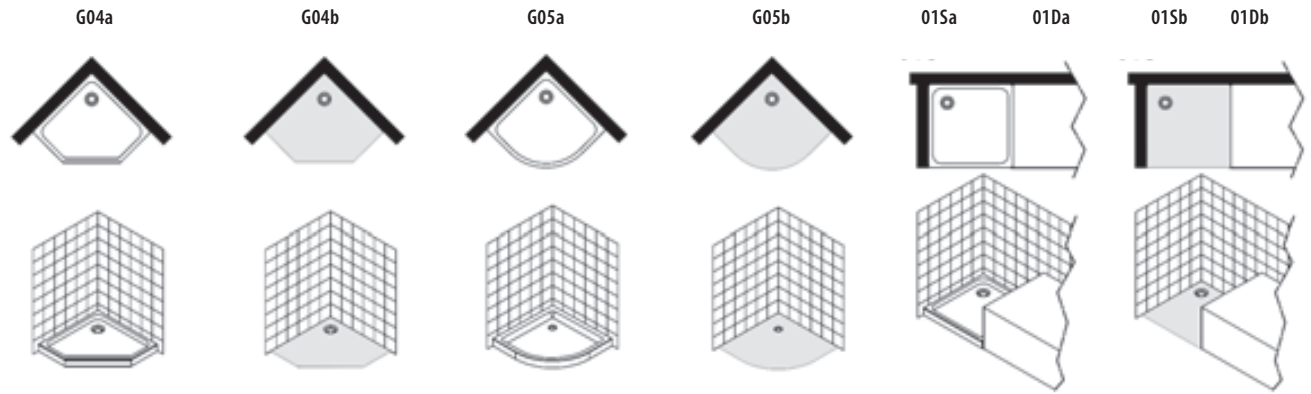

OPEN							
P058-9_B4751-57							
P058-9_B4781-87							
P058-9_B478X-Y							
P060-1_B4745-47							
P062-3_B4771-73							
P064-5_B4600-04						✓	✓
P066-7_B461X							
P068-9_B4650-53							
P070-1_B4051-57							
P070-1_B4081-87							
P072-3_B4001-09						✓	✓
P072-3_B4091-99						✓	✓
P074-5_B4073-77							
P076-7_B4040-41 B4045-49							

ZENITH							
P090-1_B9111-9115							
P092-3_B9101-9107							
P094-5_B9150-3 B9121-7						✓	✓
P096-7_B9182-9187							
P098-9_B9170-9173						✓	✓

GRAND POLARIS							
P110-1_B3705-3715							
P112-3_B3750-3760							
P114-5_B3730-3746						✓	✓

ACRUX							
P126-7_B8816-8833							
P128-9_B8880-90 B8892-97							
P130-1_B8812-8846							
P132-3_B8852-8856							
P134-5_B8801-8807							
P136-7_B8822-8827						✓	✓

EUROPA SP							
P146-7_B7916-7923							
P148-9_B7980-7991	✓	✓					
P150-1_B7970-7977							
P152-3_B7944-7948	✓	✓					
P154-5_B7924-7929						✓	✓

Prodotti speciali

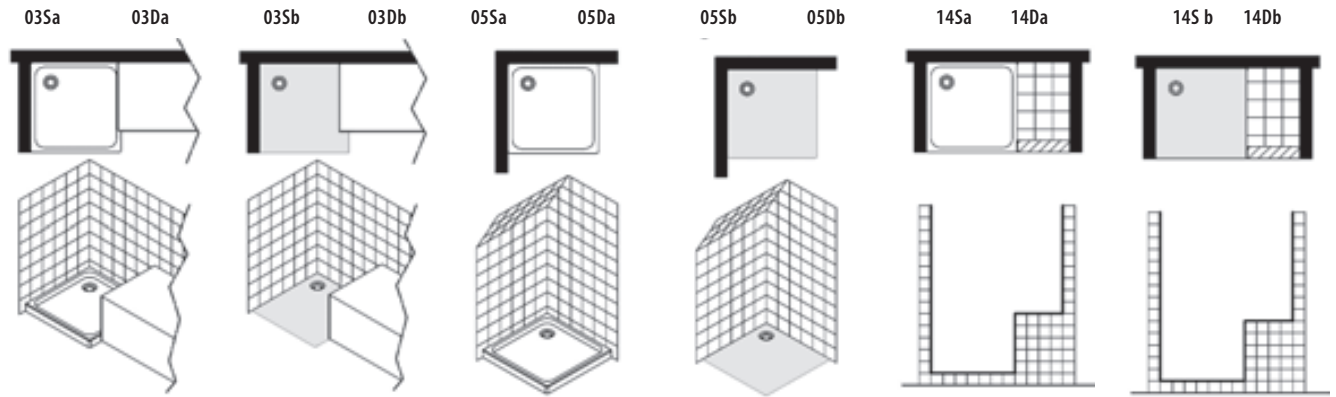

OPEN							
P058-9_B4751-57				✓	✓		
P058-9_B4781-87				✓	✓		
P058-9_B478X-Y				✓	✓		
P060-1_B4745-47				✓	✓		
P062-3_B4771-73							
P064-5_B4600-04				✓	✓	✓	✓
P066-7_B461X							
P068-9_B4650-53							
P070-1_B4051-57							
P070-1_B4081-87							
P072-3_B4001-09	✓	✓	✓	✓	✓		
P072-3_B4091-99	✓	✓	✓	✓	✓		
P074-5_B4073-77							
P076-7_B4040-41 B4045-49							

ZENITH							
P090-1_B9111-9115	✓	✓	✓	✓	✓		
P092-3_B9101-9107						✓	✓
P094-5_B9150-3 B9121-7	✓	✓	✓	✓	✓		
P096-7_B9182-9187				✓	✓	✓	✓
P098-9_B9170-9173	✓	✓	✓	✓	✓		

GRAND POLARIS							
P110-1_B3705-3715	✓	✓	✓	✓	✓		
P112-3_B3750-3760				✓	✓	✓	✓
P114-5_B3730-3746	✓	✓	✓	✓	✓	✓	✓

ACRUX							
P126-7_B8816-8833							
P128-9_B8880-90 B8892-97							
P130-1_B8812-8846							
P132-3_B8852-8856							
P134-5_B8801-8807							
P136-7_B8822-8827	✓	✓				✓	✓

EUROPA SP							
P146-7_B7916-7923							
P148-9_B7980-7991							
P150-1_B7970-7977						✓	✓
P152-3_B7944-7948							
P154-5_B7924-7929	✓	✓					

Prodotti speciali

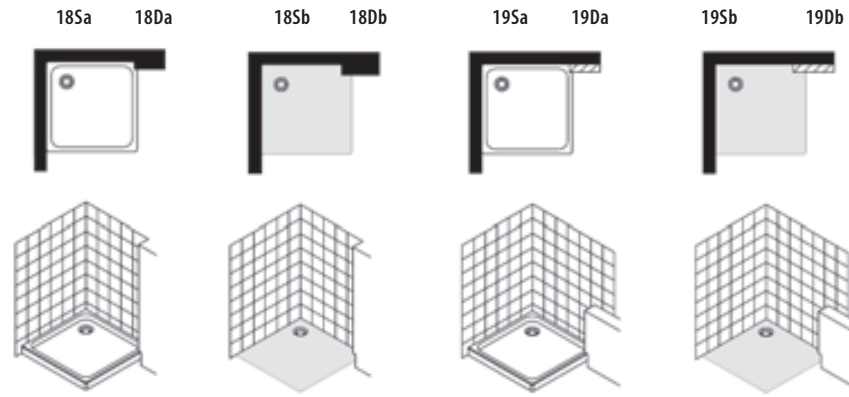

OPEN							
P058-9_B4751-57	✓		✓		✓	✓	
P058-9_B4781-87	✓		✓		✓	✓	
P058-9_B478X-Y	✓		✓		✓	✓	
P060-1_B4745-47							
P062-3_B4771-73	✓		✓		✓	✓	
P064-5_B4600-04							
P066-7_B461X							
P068-9_B4650-53							
P070-1_B4051-57	✓		✓		✓	✓	
P070-1_B4081-87	✓		✓		✓	✓	
P072-3_B4001-09	✓		✓		✓	✓	
P072-3_B4091-99	✓		✓		✓	✓	
P074-5_B4073-77							
P076-7_B4040-41 B4045-49							

ZENITH							
P090-1_B9111-9115	✓		✓		✓	✓	
P092-3_B9101-9107	✓		✓		✓	✓	
P094-5_B9150-3 B9121-7	✓		✓		✓	✓	
P096-7_B9182-9187	✓		✓		✓	✓	
P098-9_B9170-9173	✓		✓		✓	✓	

GRAND POLARIS							
P110-1_B3705-3715	✓		✓		✓	✓	
P112-3_B3750-3760							
P114-5_B3730-3746	✓		✓		✓	✓	

ACRUX							
P126-7_B8816-8833	✓		✓				
P128-9_B8880-90 B8892-97							
P130-1_B8812-8846	✓		✓				
P132-3_B8852-8856	✓		✓				
P134-5_B8801-8807	✓		✓				
P136-7_B8822-8827	✓		✓				

EUROPA SP							
P146-7_B7916-7923	✓		✓				
P148-9_B7980-7991	✓		✓				
P150-1_B7970-7977	✓		✓				
P152-3_B7944-7948	✓		✓				
P154-5_B7924-7929	✓		✓				

Prodotti speciali

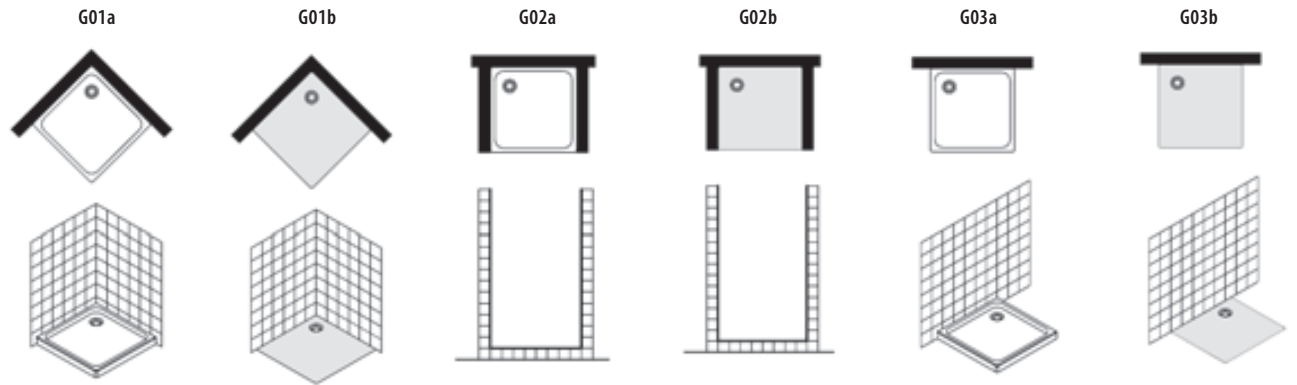

EUROPA						
P164-5_B7816-7823	✓	✓			✓	✓
P166-7_B7880-7891	✓	✓	✓	✓	✓	✓
P168-9_B7870-7875	✓	✓	✓	✓		
P170-1_B7864-7869	✓	✓	✓	✓		
P172-3_B7844-7848	✓	✓	✓	✓	✓	✓
P174-5_B7802-7806	✓	✓	✓	✓	✓	✓
P176-7_B7855-7859	✓	✓	✓	✓	✓	✓
P178-9_B7807-7811	✓	✓	✓	✓	✓	✓
P180-1_B7830-7836	✓	✓	✓	✓	✓	✓
P182-3_B7862-7863						
P184-5_B7852-7854						
P186-7_B7893-7895						
P188-9_B7824-7829	✓	✓			✓	✓

CEE ART SP						
P212-3_B0716-0723	✓	✓			✓	✓
P214-5_B0780-0790	✓	✓	✓	✓	✓	✓
P216-7_B0770-0772 / B0791-0798	✓	✓	✓	✓	✓	✓
P218-9_B0744-0748	✓	✓	✓	✓	✓	✓
P220-1_B0724-0729	✓	✓	✓	✓	✓	✓

CEE ART						
P230-1_B0916-0923	✓	✓			✓	✓
P232-3_B0980-0990	✓	✓	✓	✓	✓	✓
P234-5_B0944-0948	✓	✓	✓	✓	✓	✓
P236-7_B0900-0906	✓	✓	✓	✓		
P238-9_B0930-0938	✓	✓	✓	✓		
P240-1_B0907-0911	✓	✓	✓	✓	✓	✓
P242-3_B0952-0954						
P244-5_B0924-0929	✓	✓			✓	✓

POLARIS - ALTER						
P254-5_B3900-12	✓	✓				
P256-7_B3930-37			✓	✓		
P258-9_B3800-13	✓	✓				
P260-1_B3831-47			✓	✓		
P262-3_B3920-28	✓	✓	✓	✓		
P264-5_B3980-90	✓	✓	✓	✓		
P266-7_B3880-94	✓	✓	✓	✓		
P268-9_B3872-73-74						
P270-1_B3850-67	✓	✓				
P272-3_B9520-36	✓	✓				
P274-5_B9541-48			✓	✓		
P276-7_B9501-17	✓	✓				

Prodotti speciali

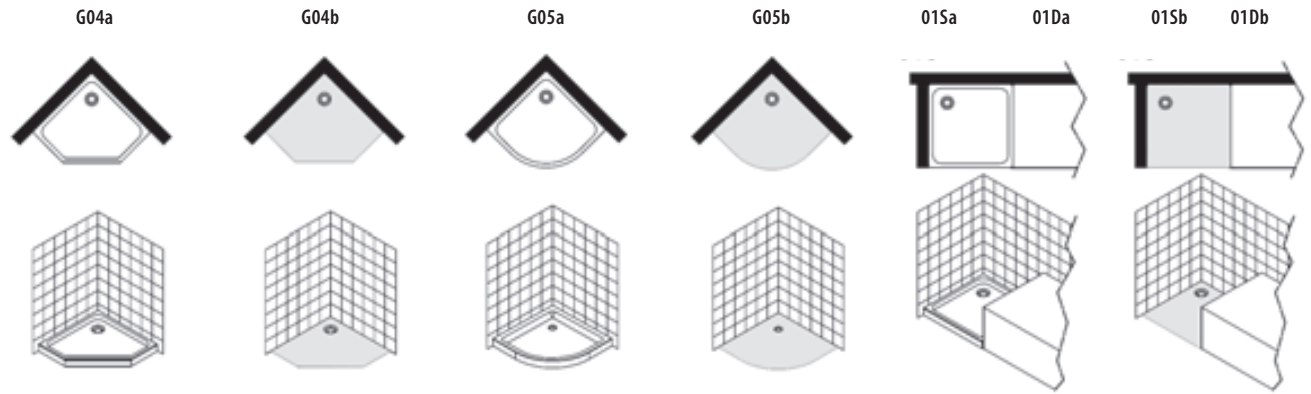

EUROPA

P164-5_B7816-7823							
P166-7_B7880-7891							
P168-9_B7870-7875							
P170-1_B7864-7869							
P172-3_B7844-7848							
P174-5_B7802-7806	✓	✓					
P176-7_B7855-7859	✓	✓					
P178-9_B7807-7811	✓	✓					
P180-1_B7830-7836	✓	✓					
P182-3_B7862-7863							
P184-5_B7852-7854			✓	✓			
P186-7_B7893-7895			✓	✓			
P188-9_B7824-7829	✓	✓			✓	✓	

CEE ART SP

P212-3_B0716-0723							
P214-5_B0780-0790	✓	✓					
P216-7_B0770-0772 / B0791-0798	✓	✓					
P218-9_B0744-0748	✓	✓					
P220-1_B0724-0729					✓	✓	

CEE ART

P230-1_B0916-0923							
P232-3_B0980-0990							
P234-5_B0944-0948							
P236-7_B0900-0906	✓	✓					
P238-9_B0930-0938	✓	✓					
P240-1_B0907-0911	✓	✓					
P242-3_B0952-0954			✓	✓			
P244-5_B0924-0929	✓	✓			✓	✓	

POLARIS - ALTER

P254-5_B3900-12							
P256-7_B3930-37							
P258-9_B3800-13							
P260-1_B3831-47							
P262-3_B3920-28							
P264-5_B3980-90							
P266-7_B3880-94							
P268-9_B3872-73-74			✓	✓			
P270-1_B3850-67					✓	✓	
P272-3_B9520-36							
P274-5_B9541-48							
P276-7_B9501-17							

Prodotti speciali

Prodotti speciali

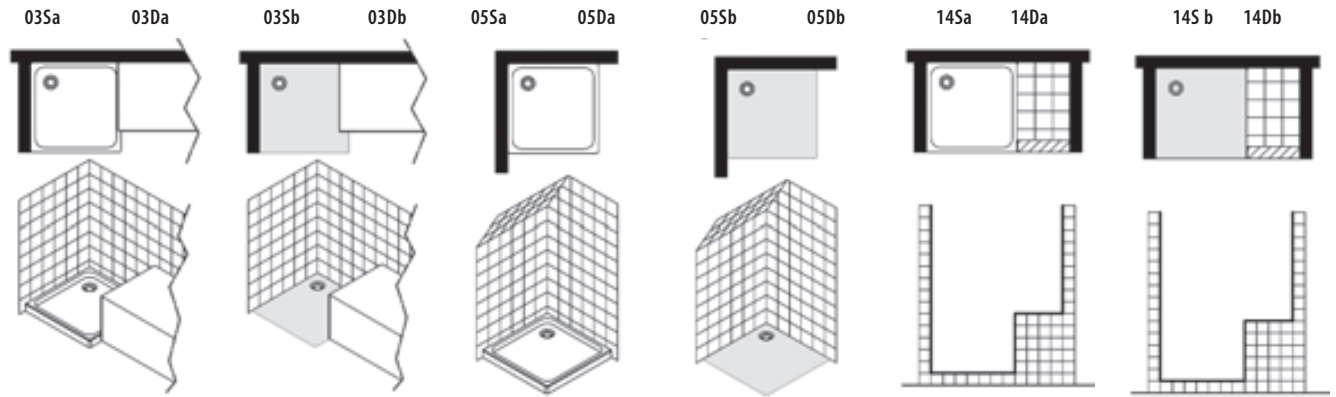

EUROPA

P164-5_B7816-7823						
P166-7_B7880-7891						
P168-9_B7870-7875						
P170-1_B7864-7869						
P172-3_B7844-7848						
P174-5_B7802-7806						
P176-7_B7855-7859						
P178-9_B7807-7811						
P180-1_B7830-7836						
P182-3_B7862-7863						
P184-5_B7852-7854						
P186-7_B7893-7895						
P188-9_B7824-7829	✓	✓	✓	✓	✓	✓

CEE ART SP

P212-3_B0716-0723						
P214-5_B0780-0790						
P216-7_B0770-0772 / B0791-0798						
P218-9_B0744-0748						
P220-1_B0724-0729	✓	✓				

CEE ART

P230-1_B0916-0923						
P232-3_B0980-0990						
P234-5_B0944-0948						
P236-7_B0900-0906						
P238-9_B0930-0938						
P240-1_B0907-0911						
P242-3_B0952-0954						
P244-5_B0924-0929	✓	✓	✓	✓	✓	✓

POLARIS - ALTER

P254-5_B3900-12						
P256-7_B3930-37						
P258-9_B3800-13						
P260-1_B3831-47			✓	✓		
P262-3_B3920-28						
P264-5_B3980-90			✓	✓		
P266-7_B3880-94						
P268-9_B3872-73-74						
P270-1_B3850-67	✓	✓	✓	✓	✓	✓
P272-3_B9520-36						
P274-5_B9541-48						
P276-7_B9501-17						

Prodotti speciali

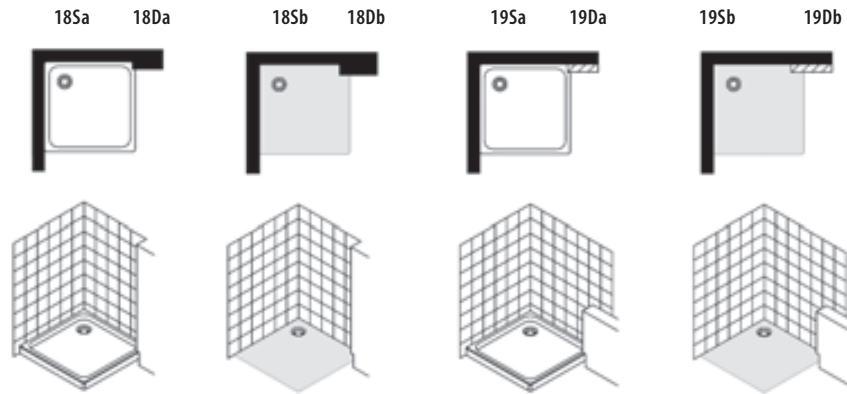

EUROPA						
P164-5_B7816-7823	✓		✓			
P166-7_B7880-7891	✓		✓			
P168-9_B7870-7875	✓		✓			
P170-1_B7864-7869	✓		✓			
P172-3_B7844-7848	✓		✓			
P174-5_B7802-7806	✓		✓			
P176-7_B7855-7859	✓		✓			
P178-9_B7807-7811	✓		✓			
P180-1_B7830-7836	✓		✓			
P182-3_B7862-7863						
P184-5_B7852-7854				✓		
P186-7_B7893-7895				✓		
P188-9_B7824-7829	✓		✓			

CEE ART SP						
P212-3_B0716-0723	✓		✓			
P214-5_B0780-0790	✓		✓			
P216-7_B0770-0772 / B0791-0798	✓		✓			
P218-9_B0744-0748	✓		✓			
P220-1_B0724-0729	✓		✓			

CEE ART						
P230-1_B0916-0923	✓		✓			
P232-3_B0980-0990	✓		✓			
P234-5_B0944-0948	✓		✓			
P236-7_B0900-0906	✓		✓			
P238-9_B0930-0938	✓		✓			
P240-1_B0907-0911	✓		✓			
P242-3_B0952-0954						
P244-5_B0924-0929	✓		✓	✓	✓	

POLARIS - ALTER						
P254-5_B3900-12	✓		✓			
P256-7_B3930-37						
P258-9_B3800-13	✓		✓	✓	✓	
P260-1_B3831-47						
P262-3_B3920-28	✓		✓			
P264-5_B3980-90	✓		✓	✓	✓	
P266-7_B3880-94	✓		✓	✓	✓	
P268-9_B3872-73-74						
P270-1_B3850-67				✓	✓	
P272-3_B9520-36	✓		✓			
P274-5_B9541-48						
P276-7_B9501-17	✓		✓			

Prodotti speciali

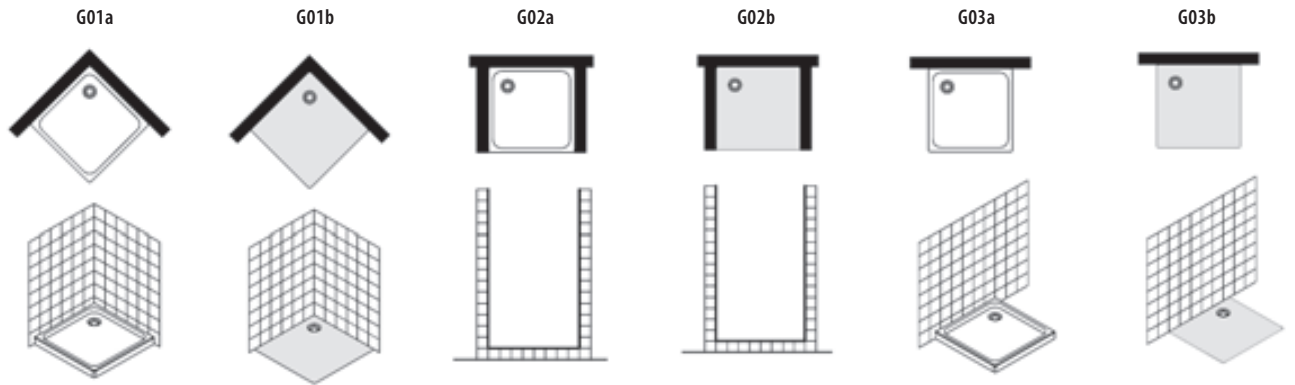

FLEX

P280_B3522-3544	✓	✓				
P281_B3625-3628	✓	✓				
P282_B3532-3538					✓	✓
P283_B3636-3638					✓	✓
P284_B3512-3518			✓	✓		

AMERICA QUATTRO SP

P290_B6312-19	✓	✓			✓	✓
P291_B6372-78	✓	✓			✓	✓
P292-3_B6382-98	✓	✓			✓	✓
P294-5_B6340-58	✓	✓	✓	✓	✓	✓
P296_B6363-69	✓	✓	✓	✓	✓	✓
P297_B6331-37	✓	✓	✓	✓	✓	✓
P298_B6321-29	✓	✓			✓	✓

AMERICA QUATTRO

P302_B6412-18	✓	✓			✓	✓
P303_B6472-77	✓	✓			✓	✓
P304-5_B6482-97	✓	✓			✓	✓
P306-7_B6440-54	✓	✓	✓	✓	✓	✓
P308_B6408-56	✓	✓	✓	✓	✓	✓
P309_B6401-07	✓	✓	✓	✓	✓	✓
P310_B6461-67	✓	✓	✓	✓	✓	✓
P311_B6431-37	✓	✓	✓	✓	✓	✓
P312_B6470-73						
P313_B6421-29	✓	✓			✓	✓

AMERICA

P316_B6816-6823	✓	✓				
P317_B6841-6808	✓	✓				
P318-9_B6830-6899	✓	✓	✓	✓	✓	✓
P320_B6844-6845	✓	✓	✓	✓	✓	✓
P321_B6835-6837	✓	✓	✓	✓		
P322_B6826-6829	✓	✓	✓	✓	✓	✓
P323_B6831-6834	✓	✓	✓	✓	✓	✓
P324_B6870-6873						
P325_B6893-6895						
P326_B6819-6821	✓	✓			✓	✓

CIAO

P330_B2601-2610	✓	✓			✓	✓
P331_B2660-2667	✓	✓	✓	✓	✓	✓
P332_B2670-2676	✓	✓	✓	✓	✓	✓

Prodotti speciali

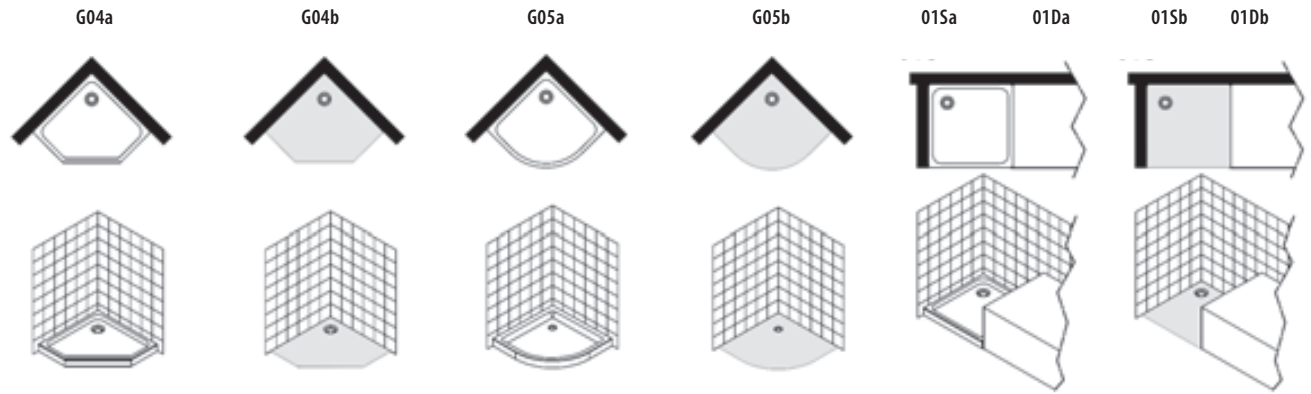

FLEX							
P280_B3522-3544							
P281_B3625-3628							
P282_B3532-3538							
P283_B3636-3638							
P284_B3512-3518							

AMERICA QUATTRO SP							
P290_B6312-19							
P291_B6372-78							
P292-3_B6382-98							
P294-5_B6340-58							
P296_B6363-69							
P297_B6331-37							
P298_B6321-29						✓	✓

AMERICA QUATTRO							
P302_B6412-18							
P303_B6472-77							
P304-5_B6482-97							
P306-7_B6440-54							
P308_B6408-56							
P309_B6401-07							
P310_B6461-67							
P311_B6431-37							
P312_B6470-73			✓	✓			
P313_B6421-29						✓	✓

AMERICA							
P316_B6816-6823							
P317_B6841-6808							
P318-9_B6830-6899							
P320_B6844-6845							
P321_B6835-6837	✓	✓					
P322_B6826-6829	✓	✓					
P323_B6831-6834	✓	✓					
P324_B6870-6873			✓	✓			
P325_B6893-6895			✓	✓			
P326_B6819-6821	✓	✓				✓	✓

CIAO							
P330_B2601-2610							
P331_B2660-2667							
P332_B2670-2676						✓	✓

Prodotti speciali

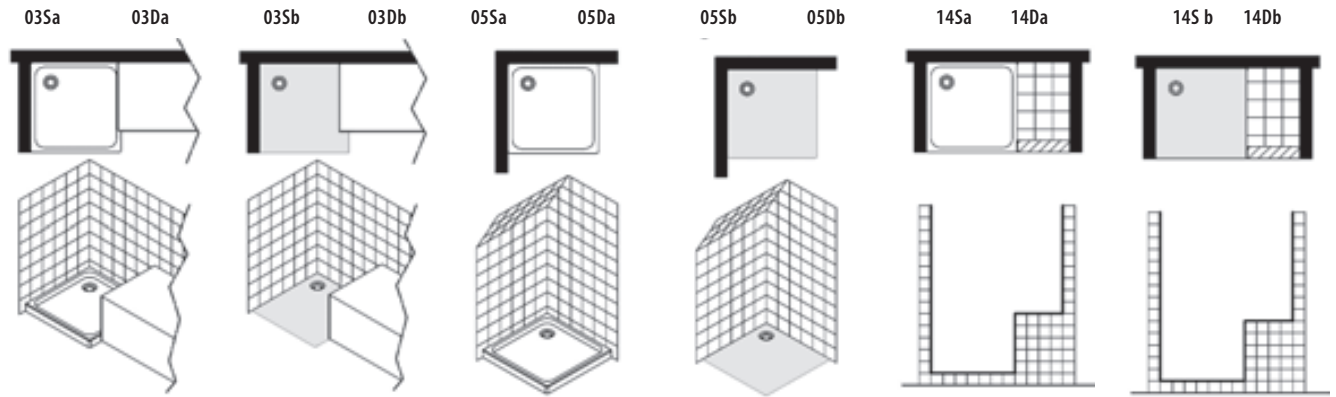

FLEX						
P280_B3522-3544						
P281_B3625-3628						
P282_B3532-3538						
P283_B3636-3638						
P284_B3512-3518						

AMERICA QUATTRO SP						
P290_B6312-19						
P291_B6372-78						
P292-3_B6382-98						
P294-5_B6340-58						
P296_B6363-69						
P297_B6331-37						
P298_B6321-29	✓	✓				

AMERICA QUATTRO						
P302_B6412-18						
P303_B6472-77						
P304-5_B6482-97						
P306-7_B6440-54						
P308_B6408-56						
P309_B6401-07						
P310_B6461-67						
P311_B6431-37						
P312_B6470-73						
P313_B6421-29	✓	✓	✓	✓		

AMERICA						
P316_B6816-6823						
P317_B6841-6808						
P318-9_B6830-6899						
P320_B6844-6845						
P321_B6835-6837						
P322_B6826-6829						
P323_B6831-6834						
P324_B6870-6873						
P325_B6893-6895						
P326_B6819-6821	✓	✓	✓	✓	✓	✓

CIAO						
P330_B2601-2610						
P331_B2660-2667						
P332_B2670-2676						

Prodotti speciali

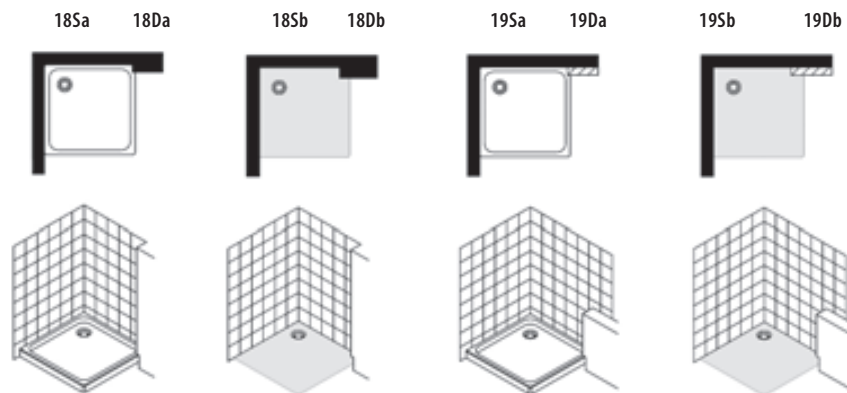

FLEX							
P280_B3522-3544	✓	✓					
P281_B3625-3628	✓	✓					
P282_B3532-3538							
P283_B3636-3638							
P284_B3512-3518							

AMERICA QUATTRO SP							
P290_B6312-19	✓	✓					
P291_B6372-78	✓	✓					
P292-3_B6382-98	✓	✓					
P294-5_B6340-58	✓	✓					
P296_B6363-69	✓	✓					
P297_B6331-37	✓	✓					
P298_B6321-29	✓	✓					

AMERICA QUATTRO							
P302_B6412-18	✓	✓					
P303_B6472-77	✓	✓					
P304-5_B6482-97	✓	✓					
P306-7_B6440-54	✓	✓					
P308_B6408-56	✓	✓					
P309_B6401-07	✓	✓					
P310_B6461-67	✓	✓					
P311_B6431-37	✓	✓					
P312_B6470-73							
P313_B6421-29	✓	✓					

AMERICA							
P316_B6816-6823	✓	✓					
P317_B6841-6808	✓	✓					
P318-9_B6830-6899	✓	✓					
P320_B6844-6845	✓	✓					
P321_B6835-6837	✓	✓					
P322_B6826-6829	✓	✓					
P323_B6831-6834	✓	✓					
P324_B6870-6873							
P325_B6893-6895							
P326_B6819-6821	✓	✓					

CIAO							
P330_B2601-2610	✓	✓					
P331_B2660-2667	✓	✓					
P332_B2670-2676	✓	✓					

Info & Servizi



Forte è l'attenzione che **samo** pone verso la possibilità di "modellare" la propria proposta, non solo in termini di prodotto, ma soprattutto come combinazioni prodotto-servizio che favoriscano il passaggio dal concetto classico di "fornitura articolata" ad una più innovativa "sinergia ad alto valore aggiunto", capace di contemplare un'articolazione di servizi strutturata ed al di sopra delle aspettative del mercato.

Nuove tavole per migliorare la realizzazione di prodotti speciali, prodotti per la cura del corpo, per la cura della cabina doccia, per l'installazione, il nuovo portale e-samo, i servizi di installazione e l'ampliamento della garanzia, si aggiungono ai servizi consolidati dei profili di compensazione e dell'area dei ricambi, fornendo molti più strumenti a chi vuole intraprendere con **samo** un rapporto di fiducia, professionalità e collaborazione.

Profili speciali, di compensazione e giunzione

Area Ricambi

Servizi pre e post-vendita

Qualità - Materiali

StarClean - Pulizia dei prodotti

e-samo web services

Profili Speciali

Articolo	Altezza [cm]	Serie	ULU (€)	SAR (€)	Atelier (€)
ALI-___-2000-A	200	Acrux			

ALI-ULU-2000-A

Per la creazione del codice del profilo speciale bisogna aggiungere la finitura scelta del profilo (es. ULU o SAR, etc.)

PER SERIE ACRUX

Attacchi laterali

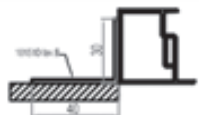

Articolo	Altezza [cm]	Serie	ULU (€)	SAR (€)	Atelier (€)
ALI-___-2000-A	200	Acrux	137	137	137

PER SERIE ACRUX

Attacchi laterali

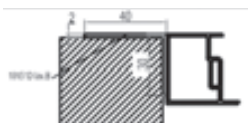

Articolo	Altezza [cm]	Serie	ULU (€)	SAR (€)	Atelier (€)
ALA-___-2000-A	200	Acrux	137	137	137

PER SERIE GRAND POLARIS

Attacchi laterali



Articolo	Altezza [cm]	Serie	ULU (€)	L91 (€)	L96 (€)
ALI-___-1950-B	195	Grand Polaris	137	137	137

PER SERIE GRAND POLARIS

Attacchi laterali

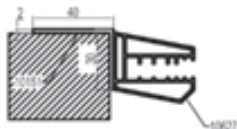

Articolo	Altezza [cm]	Serie	ULU (€)	L91 (€)	L96 (€)
ALA-___-1950-B	195	Grand Polaris	137	137	137

PER SERIE EUROPA - EUROPA SP

Attacchi laterali

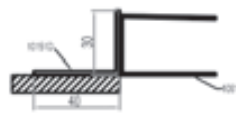

Articolo	Altezza [cm]	Serie	L01 (€)	SAR (€)	ULU(€)
ALI-___-2000-D	200	Europa	89	137	137
ALI-___-1965-D	196,5	Europa SP	89	137	137

PER SERIE EUROPA - EUROPA SP

Attacchi laterali

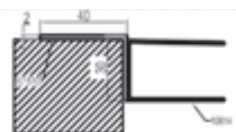

Articolo	Altezza [cm]	Serie	L01 (€)	SAR (€)	ULU(€)
ALA-___-2000-D	200	Europa	89	137	137
ALA-___-1965-D	196,5	Europa SP	89	137	137

Altezza maggiore +35 €
Prezzo standard di riferimento
Altezza inferiore +35 €

Profili Speciali

PER SERIE CEE ART - CEE ART SP

Attacchi laterali

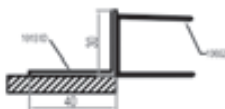

Articolo	Altezza [cm]	Serie	L01 (€)	ULU (€)	L91-L95-L96(€)
ALI-_-_-1950-A	195	Cee Art	89	137	137
ALI-_-_-1965-A	196,5	Cee Art SP	89	137	137

PER SERIE CEE ART - CEE ART SP

Attacchi laterali

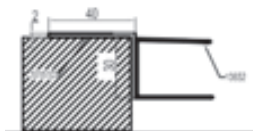

Articolo	Altezza [cm]	Serie	L01 (€)	ULU (€)	L91-L95-L96 (€)
ALA-_-_-1950-A	195	Cee Art	89	137	137
ALA-_-_-1965-A	196,5	Cee Art SP	89	137	137

PER SERIE POLARIS - ALTER

Attacchi laterali

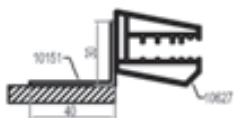

Articolo	Altezza [cm]	Serie	ULU (€)	L91 (€)	L96 (€)
ALI-_-_-1950-D	195	Polaris - Alter	137	137	137

PER SERIE POLARIS - ALTER

Attacchi laterali

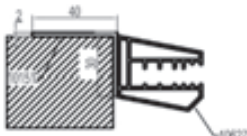

Articolo	Altezza [cm]	Serie	ULU (€)	L91 (€)	L96 (€)
ALA-_-_-1950-D	195	Polaris - Alter	137	137	137

PER SERIE POLARIS - ALTER

Attacchi laterali

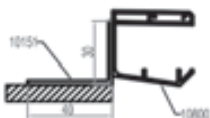

Articolo	Altezza [cm]	Serie	ULU (€)	L91 (€)	L96 (€)
ALI-_-_-1950-E	195	Polaris - Alter	137	137	137

PER SERIE POLARIS - ALTER

Attacchi laterali

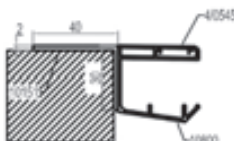

Articolo	Altezza [cm]	Serie	ULU (€)	L91 (€)	L96 (€)
ALA-_-_-1950-E	195	Polaris - Alter	137	137	137

PER SERIE POLARIS - ALTER

Attacchi laterali

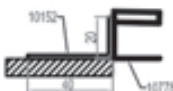

Articolo	Altezza [cm]	Serie	ULU (€)	L91 (€)	L96 (€)
ALI-_-_-1950-F	195	Polaris - Alter	137	137	137

PER SERIE POLARIS - ALTER

Attacchi laterali

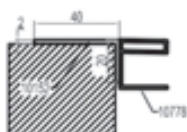

Articolo	Altezza [cm]	Serie	ULU (€)	L91 (€)	L96 (€)
ALA-_-_-1950-F	195	Polaris - Alter	137	137	137

Profili Speciali

PER SERIE AMERICA QUATTRO

Attacchi laterali



Articolo	Altezza [cm]	Serie	ULU (€)	L91 (€)	L96 (€)
ALI-1900-D	190	America quattro	137	137	137

PER SERIE AMERICA QUATTRO

Attacchi laterali



Articolo	Altezza [cm]	Serie	ULU (€)	L91 (€)	L96 (€)
ALA-1900-D	190	America quattro	137	137	137

PER SERIE AMERICA QUATTRO SP

Attacchi laterali



Articolo	Altezza [cm]	Serie	ULU (€)	L91 (€)	L96 (€)
ALI-1900-A	190	America quattro SP	137	137	137

PER SERIE AMERICA QUATTRO SP

Attacchi laterali

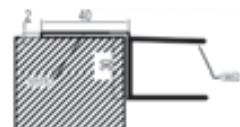

Articolo	Altezza [cm]	Serie	ULU (€)	L91 (€)	L96 (€)
ALA-1900-A	190	America quattro SP	137	137	137

PER SERIE CIAO

Attacchi laterali

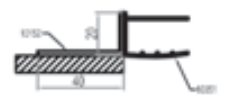

Articolo	Altezza [cm]	Serie	L01 (€)
ALI-L01-1850-E	185	Ciao	89

PER SERIE CIAO

Attacchi laterali

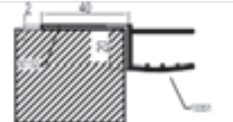

Articolo	Altezza [cm]	Serie	L01 (€)
ALA-L01-1850-E	185	Ciao	89

PER SERIE AMERICA - FLEX

Attacchi laterali



Articolo	Altezza [cm]	Serie	L01 (€)	ULU (€)
ALI-1850-A	185	America - Flex	89	137

PER SERIE AMERICA - FLEX

Attacchi laterali

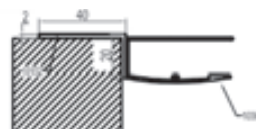

Articolo	Altezza [cm]	Serie	L01 (€)	ULU (€)
ALA-1850-A	185	America - Flex	89	137

Profili di Compensazione e di Giunzione

PER TUTTE LE SERIE DI BOX DOCCIA

Attacchi inclinati

Articolo	Descrizione	L01 (€)	ULU-SAR (€)	Atelier L55-L73-L86 (€)	SNK (€)
Su richiesta*	Attacco inclinato	103	139	139	167

* Contattare l'Ufficio Clienti per la fattibilità.

Pareti di solo profilo

Articolo	Descrizione	L01 (€)	ULU-SAR (€)	Atelier L55-L73-L86 (€)	SNK (€)
Su richiesta*	larghezza fino a cm. 10	103	139	139	167
Su richiesta*	larghezza oltre cm. 10 - max cm. 20	178	248	248	298

* Contattare l'Ufficio Clienti per la fattibilità.

Profilo di congiunzione

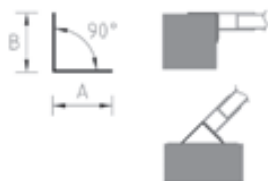

Articolo	Altezza [cm]	Misure Max ingombro [cm]	L01 (€)	SAR (€)	ULU (€)
C015	185	4x1	52	79	79
C015A	190	4x1	52	79	79
C015C	195	4x1	52	79	79
C015B	200	4x1	55	83	83
C016	185	4x2	50	78	78
C016A	190	4x2	50	78	78
C016C	195	4x2	50	78	78
C016B	200	4x2	53	82	82
C017	185	4x3	57	87	87
C017A	190	4x3	57	87	87
C017C	195	4x3	57	87	87
C017B	200	4x3	60	90	90
C018	185	4x4	60	90	90
C018A	190	4x4	60	90	90
C018C	195	4x4	62	96	96
C018B	200	4x4	62	96	96

Profilo di compensazione

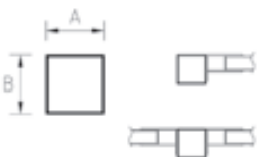

Articolo	Altezza [cm]	Misure Max ingombro [cm]	L01 (€)	SAR (€)	ULU (€)
COM41	185	4x1	58	89	89
COM41A	190	4x1	58	89	89
COM41C	195	4x1	61	93	93
COM41B	200	4x1	61	93	93
COM42	185	4x2	72	109	109
COM42A	190	4x2	72	109	109
COM42C	195	4x2	77	116	116
COM42B	200	4x2	77	116	116
COM43	185	4x3	83	125	125
COM43A	190	4x3	83	125	125
COM43C	195	4x3	87	131	131
COM43B	200	4x3	87	131	131
COM44	185	4x4	87	131	131
COM44A	190	4x4	87	131	131
COM44C	195	4x4	90	139	139
COM44B	200	4x4	90	139	139

Altezza maggiore +35 €

Prezzo standard di riferimento

Altezza inferiore +35 €

Profili di Compensazione e di Giunzione

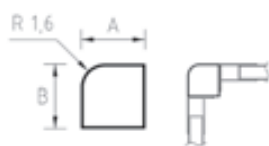

Profilo di congiunzione

Articolo	Altezza [cm]	Misure Max ingombro [cm]	L01 (€)	SAR (€)	ULU (€)
C010	185	4,3x4,3	61	93	93
C010A	190	4,3x4,3	61	93	93
C010C	195	4,3x4,3	61	93	93
C010B	200	4,3x4,3	64	101	101



PER SERIE AMERICA QUATTRO - AMERICA

Profilo di compensazione

Articolo	Serie	Altezza [cm]	Estensibilità [cm]	L01 (€)	SAR (€)	ULU (€)	L91- L96 (€)
COM7	America	185	0-4	60	90	90	//
COM7A	America Quattro	190	0-4	//	//	90	90

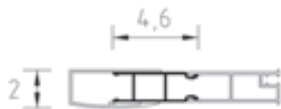

PER SERIE AMERICA QUATTRO - AMERICA

Profilo di congiunzione

Articolo	Serie	Altezza [cm]	Estensibilità [cm]	L01 (€)	SAR (€)	ULU (€)	L91- L96 (€)
C074	America	185	0-2	55	83	83	//
C074A	America Quattro	190	0-2	//	//	64	64

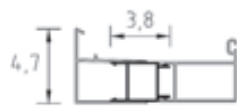

PER SERIE EUROPA - EUROPA SP - CEE ART SP- CEE ART - AMERICA QUATTRO SP

Profilo di compensazione

Articolo	Serie	Altezza [cm]	Estensibilità [cm]	L01 (€)	L91 - L96 (€)	SAR (€)	ULU (€)	L95 (€)
COM10A	Europa	200	0-3	60	//	90	90	//
COM10B	Europa SP	196,5	0-3	60	//	90	90	//
COM10B	Cee Art SP	196,5	0-3	//	90	90	90	90
COM10C	Cee Art	195	0-3	60	90	90	90	90
COM10D	America quattro SP	190	0-3	//	90	90	90	//

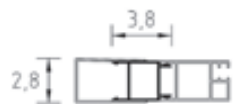

PER SERIE EUROPA - EUROPA SP - CEE ART SP- CEE ART - AMERICA QUATTRO SP

Profilo di compensazione

Articolo	Serie	Altezza [cm]	Estensibilità [cm]	L01 (€)	L91 - L96 (€)	SAR (€)	ULU (€)	L95 (€)
C0171A	Europa	200	0-3	76	//	89	89	//
C0171B	Europa SP	196,5	0-3	76	//	89	89	//
C0171B	Cee Art SP	196,5	0-3	//	89	89	89	89
C0171C	Cee Art	195	0-3	76	89	89	89	89
C0171D	America quattro SP	190	0-3	//	89	89	89	//

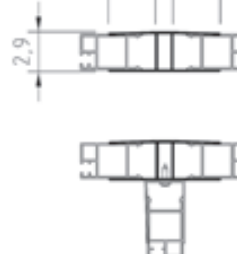

Profili di Compensazione e di Giunzione

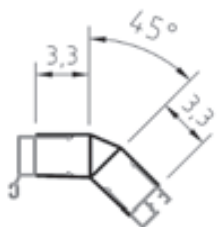

PER SERIE EUROPA - EUROPA SP - CEE ART SP- CEE ART - AMERICA QUATTRO SP

Profilo di compensazione

Articolo	Serie	Altezza [cm]	Estensibilità [cm]	L01 (€)	L91 - L96 (€)	SAR (€)	ULU (€)	L95 (€)
C0172A	Europa	200	0-3	76	//	89	89	//
C0172B	Europa SP	196,5	0-3	76	//	89	89	//
C0172B	Cee Art SP	196,5	0-3	//	89	89	89	89
C0172C	Cee Art	195	0-3	76	89	89	89	89
C0172D	America quattro SP	190	0-3	//	89	89	89	//

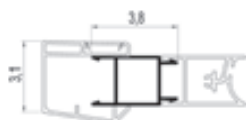
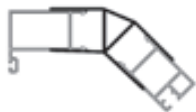

PER SERIE POLARIS

Profilo di compensazione

Articolo	Serie	Altezza [cm]	Estensibilità [cm]	ULU (€)	L91 - L96 (€)
COM38A	Polaris	195	0-3	90	90

Indicato solamente per le porte con snodo

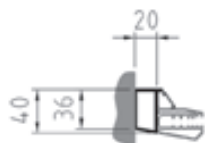

Articolo	Serie	Altezza [cm]	Estensibilità [cm]	ULU (€)	L91 - L96 (€)
COM39A	Polaris	195	0-2	64	64

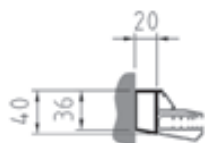

PER SERIE GRAND POLARIS

Profilo di compensazione

Articolo	Serie	Altezza [cm]	Estensibilità [cm]	ULU (€)	L91 - L96 (€)
COM50A	Grand Polaris	195	0-2	64	64



PER SERIE CON PANNELLI IN POLYSTYRENE

Profilo di congiunzione

Articolo	Altezza [cm]	Estensibilità [cm]	L01 (€)	SAR (€)	ULU (€)
C074	185	0-2	55	83	83

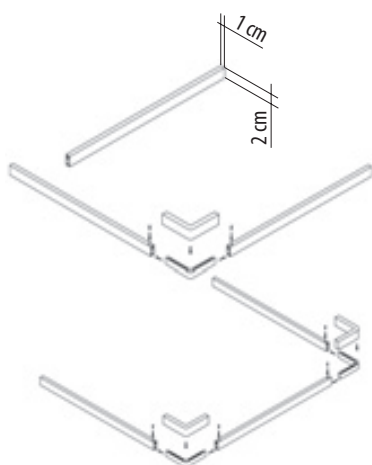

PER SERIE FLEX

Articolo	Altezza [cm]	Misure Max ingombro [cm]	L01 (€)
C0118	185	91	36
C0128	185	92x92	50
C0138	185	91x91x91	61
C0148	185	120x120x120	73
C0158	185	120	47
C0168	185	120x120	61

Altezza maggiore +35 €
Prezzo standard di riferimento
Altezza inferiore +35 €

Profili di Compensazione per attacchi inclinati

Profilo di compensazione per attacco inclinato

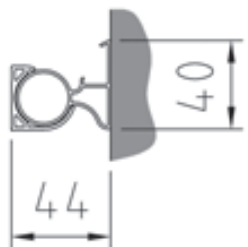

Articolo	Altezza [cm]		LO1 (€)	SAR (€)	ULU (€)	ATELIER (€)
COM49A	200	Zenith - Acrux - Open Side	99	128	128	128
COM49B	195	Grand Polaris - Polaris	//	//	126	126
COM49C	190	Alter - America quattro	//	//	125	125
COM49E	185	America - Flex	95	123	123	123
COM49F	183,5	Flex	94	//	//	//
COM49G	160	Pareti vasca	88	//	117	//
COM49H	150	Pareti vasca	85	//	105	//
COM49I	140	Pareti vasca	83	//	103	//
COM49L	135	Pareti vasca	82	//	//	//
COM49M	100	Flex	66	//	//	//

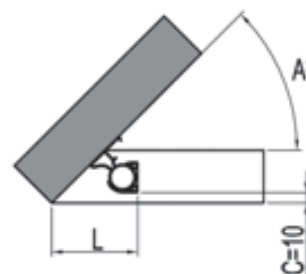
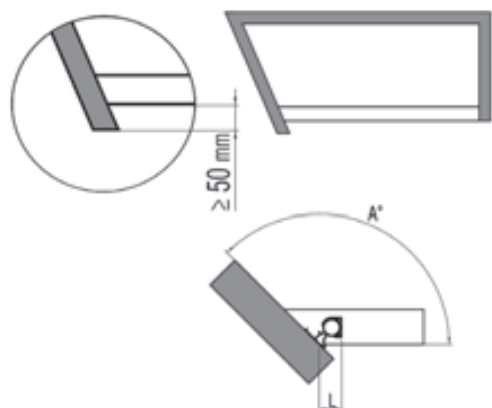

Per Esterno piatto e Metà piatto tenere almeno 50 mm. di muro oltre il piatto

	Esterno piatto	Metà piatto	Interno piatto
Angolo [°]	Larghezza [mm]	Larghezza [mm]	Larghezza [mm]
90°	44	44	44
95°	43	42	41
100°	42	41	39
105°	42	39	36
110°	41	37	34
115°	41	36	31
120°	41	35	29
125°	41	34	27
130°	42	33	25
135°	42	32	22
140°	44	32	20
145°	46	32	18
150°	50	32	15

	Esterno piatto	Metà piatto	Interno piatto
Angolo [°]	Larghezza [mm]	Larghezza [mm]	Larghezza [mm]
25°	116	138	159
30°	99	117	134
35°	87	101	116
40°	78	90	102
45°	71	81	91
50°	66	74	82
55°	61	68	75
60°	57	63	69
65°	54	59	63
70°	52	55	59
75°	49	52	55
80°	47	49	51
85°	46	47	47
90°	44	44	44

Profili di Compensazione per attacchi inclinati

PER SERIE EUROPA - EUROPA SP - CEE ART SP - CEE ART - AMERICA QUATTRO SP - B1450 - B1480 - B1490

Profilo di compensazione per attacco inclinato

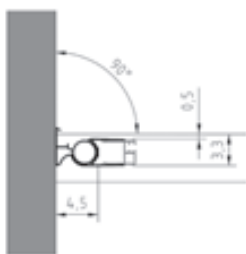

Articolo	Altezza [cm]	Estensibilità [cm]		L01 (€)	SAR (€)	ULU (€)	ATELIER (€)
COM45A	200	0-3	Europa	115	148	148	148
COM45B	196,5	0-3	Europa SP - Cee Art SP	115	148	148	148
COM45C	195	0-3	Cee Art	108	127	127	127
COM45D	190	0-3	America quattro SP	93	112	112	112
COM45E	187,5	0-3	Acrux	93	//	112	112
COM45F	150	0-3	B1450	80	//	99	//
COM45G	140	0-3	B1480 - B1490	78	//	96	//

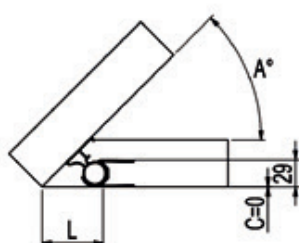

Da 0° a 90° C=0	
A [°]	L [mm]
25°	111
30°	94
35°	82
40°	73
45°	66
50°	60
55°	56
60°	52
65°	49
70°	46
75°	44
80°	42
85°	40
90°	39

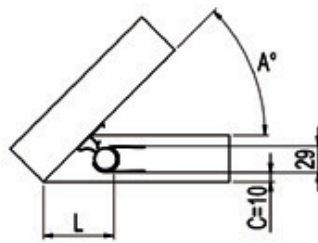

Da 0° a 90° C=10	
A [°]	L [mm]
25°	132
30°	111
35°	96
40°	85
45°	76
50°	69
55°	63
60°	58
65°	53
70°	50
75°	47
80°	44
85°	41
90°	39

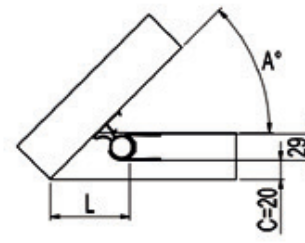

Da 0° a 90° C=20	
A [°]	L [mm]
25°	154
30°	129
35°	110
40°	97
45°	86
50°	77
55°	70
60°	63
65°	58
70°	53
75°	49
80°	45
85°	42
90°	39

Per Esterno piatto e Metà piatto tenere almeno 50 mm. di muro oltre il piatto

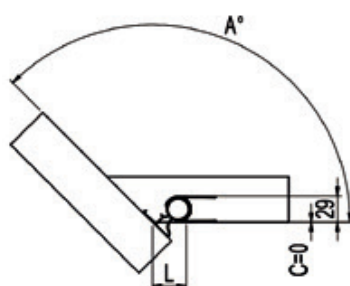

Da 0° a 90° C=0	
A [°]	L [mm]
90°	39
95°	38
100°	37
105°	36
110°	36
115°	35
120°	35
125°	36
130°	36
135°	37
140°	39
145°	41
150°	44

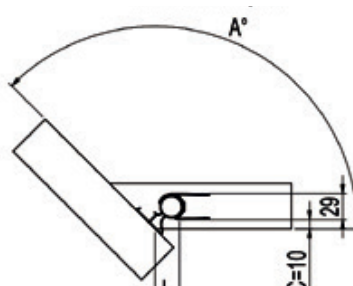

Da 0° a 90° C=10	
A [°]	L [mm]
90°	39
95°	37
100°	35
105°	34
110°	32
115°	31
120°	30
125°	29
130°	28
135°	27
140°	27
145°	27
150°	27

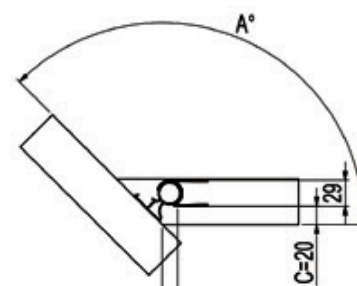

Da 0° a 90° C=20	
A [°]	L [mm]
90°	39
95°	36
100°	33
105°	31
110°	28
115°	26
120°	24
125°	22
130°	19
135°	17
140°	15
145°	12
150°	10

Ricambi

Open

B4001-99 / B4001-09
 B4081-87 / B4081-57
 B4073-7
 B4000-49
 B4781-87 / B4751-57
 B4745-47
 B4771-73
 B478X-10487Y
 B4600-1-2-3-4
 B4650-1-2-3

Codice	Descrizione	Modelli										€	
		B4001-99 / B4001-09	B4081-87 / B4081-57	B4073-7	B4000-49	B4781-87 / B4751-57	B4745-47	B4771-73	B478X-10487Y	B4600-1-2-3-4	B4650-1-2-3		
RIC820	Gruppo guarnizioni inferiori												24
RIC863C	Pomello cromo												21
RIC864C	Gruppo maniglie cromo												28
RIC880	Sacchetto viteria fissaggio a muro												14
RIC1000	Guarnizione inferiore Open Surf/Side												31
RIC1001C	Cerniera a scatto cromo Open Side												96
RIC1106C	Gruppo blocca frangiflutto cromo												20
RIC1116ULU	Gruppo frangiflutto ULU												26
RIC1184	Gruppo guarnizione orizzontale												40
RIC1199C	Gruppo camme per snodo cromo												45
RIC1215C	N° 1 supporto vetro-muro (cm. 80)												128
RIC1217C	N° 2 blocchetti inferiori fissaggio vetro												78
RIC1394ULU	Profilo a muro lato battente h=2025												58
RIC1395ULU	Carter profilo lato battente h=2025												48
RIC1648	Gruppo guarnizioni magnetiche 45° per porte Open												48
RIC1760ULU	Profilo a muro ULU Open Shot												84
RIC1760L96	Profilo a muro L96 Open Shot												84
RIC1761ULU	Barra stabilizzatrice ULU Open Shot												162
RIC1762	Guarnizioni fermavetro verticale-lastra												24
RIC1809CR0	N° 1 Supporto vetro-muro (120 cm.)												100
RIC1809L96	N° 1 Supporto vetro-muro (120 cm.)												100
RIC1810CR0	N° 1 Supporto attacco a vetro												45
RIC1810L96	N° 1 Supporto attacco a vetro												45
RIC1811CR0	N° 1 Cover esterna attacco a vetro												31
RIC1811L96	N° 1 Cover esterna attacco a vetro												31
RIC1812CR0	N° 1 Supporto per fissaggio a muro												39
RIC1812L96	N° 1 Supporto per fissaggio a muro												39
RIC1813	N° 1 Confezione fissaggio supporto vetro/muro												29
RIC1814ULU	N° 1 Profilo a muro Open Side												109
RIC1814L91/L96	N° 1 Profilo a muro Open Side												109
RIC2574L96	Braccetto L96 (120 mm.)												31
RIC2576L96	Braccetto L96 (670 mm.)												36
RIC2577L96	Attacco a vetro per braccetto												82
RIC2583L96	Tubo per braccetto di sostegno (1160 mm.)												53
RIC840	Sacchetto viti fissaggio a muro Open s.												19
RIC2994L91/L96	Profilo verticale a muro Open scorr L91												84
RIC2994ULU	Profilo verticale a muro Open scorr ULU												84
RIC2995	Guarnizione palloncino l=2300												44
RIC2996	Profilo fermavetro l=2300												42
RIC2997	Guarnizione aletta l=10mm l=2300												42
RIC2998	Guarnizione labbro l=2200mm												48
RIC2999L91/L96	Traverso scorrimento superiore L91												44
RIC2999ULU	Traverso scorrimento superiore ULU												44
RIC3000L91/L96	Profilo guida inf-frangiflutto L91												29
RIC3000ULU	Profilo guida inf-frangiflutto ULU												29
RIC3001CR0	Tappo fissaggio profilo superiore cro												28
RIC3001L91/L96	Tappo fissaggio profilo superiore L91												28
RIC3002CR0	Assieme scorrimento walk in-open cro												117
RIC3002L91/L96	Assieme scorrimento walk in-open L91												117
RIC3003CR0	Terminale kit scorr. Open sco cromo												37
RIC3003L91/L96	Terminale kit scorr. Open sco L91												37
RIC3004CR0	Blocchetto ferma anta cromo												24
RIC3004L91/L96	Blocchetto ferma anta L91												24
RIC3005CR0	Blocchetto guida inferiore dx cromo												32
RIC3005L91/L91	Blocchetto guida inferiore dx L91												32
RIC3006CR0	Blocchetto guida inferiore sx cromo												32
RIC3006L91/L96	Blocchetto guida inferiore sx L91												32
RIC3007ULU	Kit superiore walk in-open scorr. ULU												96
RIC3007L91/L96	Kit superiore walk in-open scorr. L91												96
RIC3008ULU	Prof.Vert. Muro p.Fissa open scorr ULU												69
RIC3008L91/L96	Prof.Vert. Muro p.Fissa open scorr L91												69

Ricambi

Open

Codice	Descrizione												€		
		B4001-99 / B4001-09	B4081-87 / B4051-57	B4073-7	B4040-49	B4781-87 / B4751-57	B4745-47	B4771-73	B4788-18-87Y	B4600-1-2-3-4	B4650-1-2-3				
RIC1184	Gruppo guarnizione orizzontale											•			40
RIC1624	Gruppo prof. Magnetici (1 box completo)											•			46
RIC1624L96	Gruppo prof. Magnetici (1 box completo)											•			46
RIC2310ULU	Gruppo maniglia cro											•			51
RIC2310L91/L96	Gruppo maniglia L91											•			62
RIC2564	Guarnizione fermavetro								•	•					26
RIC2589	Kit camma di rotazione cerniera											•			20
RIC2591	Guarnizione verticale x cerniera											•			29
RIC2714ULU	Gruppo snodo muro ULU											•			36
RIC2714L91/L96	Gruppo snodo muro L91											•			36
RIC2747	Guarnizione spazzolino											•			23
RIC2987ULU	Gruppo mensola cm 60								•	•					123
RIC2987L91	Gruppo mensola cm 60								•	•					123
RIC2987L96	Gruppo mensola cm 60								•	•					123
RIC2988ULU	Gruppo supporto mensola								•	•					31
RIC2988L91/L96	Gruppo supporto mensola								•	•					31
RIC2989	Guarnizione orizzontale											•			25
RIC2990ULU	Kit staffe deflettore											•			96
RIC2990L91/L96	Kit staffe deflettore											•			96
RIC2991L01	N°1 carter profilo a muro L01												•		34
RIC2991L96	N°1 carter profilo a muro nero												•		34
RIC2991ULU	N°1 carter profilo a muro grigio												•		34
RIC2992ULU	N°1 profilo a muro												•		76
RIC2992L91/L96	N°1 profilo a muro												•		76
RIC2993ULU	Gruppo profilo di battuta												•		103
RIC2993L91/L96	Gruppo profilo di battuta												•		103

Ricambi

Zenith

Codice	Descrizione	modelli						€
		B9111-15	B9101-07	B9121-27	B9100-53	B9102-87	B9170-73	
RIC880	Sacchetto viti fissaggio a muro	•	•	•	•	•	•	14
RIC2453	Maniglia esterna e pomolo interno	•	•	•	•	•	•	71
RIC2524ULU	Gruppo profilo a muro ULU	•	•	•	•	•	•	109
RIC2525ULU	Profilo carter ULU	•	•	•	•	•	•	47
RIC2526	Gruppo guarnizioni profilo a muro	•	•	•	•	•	•	21
RIC2527	Gruppo tappi zenith	•	•	•	•	•	•	28
RIC2528ULU/SX	Gruppo componenti cerniera sx	•	•	•	•	•	•	77
RIC2528ULU/DX	Gruppo componenti cerniera dx	•	•	•	•	•	•	77
RIC2529ULU	Cover cerniera zenith	•	•	•	•	•	•	41
RIC2530ULU	Gruppo zanca angolo	•	•	•	•	•	•	119
RIC2531ULU	Gruppo maniglia vetro zenith	•	•	•	•	•	•	334
RIC2532	Guarnizione verticale palloncino	•	•	•	•	•	•	32
RIC2533	Guarnizione magnetica	•	•	•	•	•	•	31
RIC2535ULU	Gruppo frangiflutto B9101-11-21	•	•	•	•	•	•	36
RIC2536ULU	Gruppo frangiflutto B9102-12-22-82	•	•	•	•	•	•	41
RIC2537ULU	Gruppo frangiflutto B9103-13-23	•	•	•	•	•	•	39
RIC2538ULU	Gruppo frangiflutto B9184-85	•	•	•	•	•	•	40
RIC2539ULU	Gruppo frangiflutto B9105-07-15-25-27-87	•	•	•	•	•	•	40
RIC2540/SX	Gruppo guarnizione inferiore B9111 SX	•	•	•	•	•	•	24
RIC2540/DX	Gruppo guarnizione inferiore B9111 DX	•	•	•	•	•	•	24
RIC2541/SX	Gruppo guarnizione inferiore B9112 SX	•	•	•	•	•	•	24
RIC2541/DX	Gruppo guarnizione inferiore B9112 DX	•	•	•	•	•	•	24
RIC2542/SX	Gruppo guarnizione inferiore B9113 SX	•	•	•	•	•	•	24
RIC2542/DX	Gruppo guarnizione inferiore B9113 DX	•	•	•	•	•	•	24
RIC2543/SX	Gruppo guarnizione inferiore B9115 SX	•	•	•	•	•	•	24
RIC2543/DX	Gruppo guarnizione inferiore B9115 DX	•	•	•	•	•	•	24
RIC2544ULU	Profilo a muro battuta ULU	•	•	•	•	•	•	52
RIC2545ULU	Gruppo profilo verticale battuta	•	•	•	•	•	•	44
RIC2546	Guarnizioni magnetiche	•	•	•	•	•	•	36
RIC2547ULU	Gruppo a muro kit di sostegno ULU	•	•	•	•	•	•	36
RIC2548ULU	Gruppo lastra kit di sostegno	•	•	•	•	•	•	77
RIC2549ULU	Gruppo lastra kit di sostegno B9121-7	•	•	•	•	•	•	146
RIC2550ULU/SX	Gruppo kit sostegno B9101 SX	•	•	•	•	•	•	89
RIC2550ULU/DX	Gruppo kit sostegno B9101 DX	•	•	•	•	•	•	89
RIC2551ULU/SX	Gruppo kit sostegno B9102 SX	•	•	•	•	•	•	89
RIC2551ULU/DX	Gruppo kit sostegno B9102 DX	•	•	•	•	•	•	89
RIC2552ULU/SX	Gruppo kit sostegno B9103 SX	•	•	•	•	•	•	93
RIC2552ULU/DX	Gruppo kit sostegno B9103 DX	•	•	•	•	•	•	93
RIC2553ULU/SX	Gruppo kit sostegno B9105 SX	•	•	•	•	•	•	95
RIC2553ULU/DX	Gruppo kit sostegno B9105 DX	•	•	•	•	•	•	95
RIC2554ULU/SX	Gruppo kit sostegno B9107 SX	•	•	•	•	•	•	96
RIC2554ULU/DX	Gruppo kit sostegno B9107 DX	•	•	•	•	•	•	96
RIC2555ULU/SX	Gruppo kit sostegno B9121 SX	•	•	•	•	•	•	312
RIC2555ULU/DX	Gruppo kit sostegno B9121 DX	•	•	•	•	•	•	312
RIC2556ULU/SX	Gruppo kit sostegno B9122 SX	•	•	•	•	•	•	313
RIC2556ULU/DX	Gruppo kit sostegno B9122 DX	•	•	•	•	•	•	313
RIC2557ULU/SX	Gruppo kit sostegno B9123 SX	•	•	•	•	•	•	317
RIC2557ULU/DX	Gruppo kit sostegno B9123 DX	•	•	•	•	•	•	317
RIC2558ULU/SX	Gruppo kit sostegno B9125 SX	•	•	•	•	•	•	318
RIC2558ULU/DX	Gruppo kit sostegno B9125 DX	•	•	•	•	•	•	318
RIC2559ULU/SX	Gruppo kit sostegno B9127 SX	•	•	•	•	•	•	322
RIC2559ULU/DX	Gruppo kit sostegno B9127 DX	•	•	•	•	•	•	322
RIC2560ULU	Gruppo kit sostegno B9182	•	•	•	•	•	•	274
RIC2561ULU	Gruppo kit sostegno B9184	•	•	•	•	•	•	276
RIC2562ULU	Gruppo kit sostegno B9185	•	•	•	•	•	•	276
RIC2563ULU	Gruppo kit sostegno B9187	•	•	•	•	•	•	281
RIC2564	Guarnizione fermavetro	•	•	•	•	•	•	26
RIC2565/SX	Gruppo guarnizione inferiore B9101-21 SX	•	•	•	•	•	•	24
RIC2565/DX	Gruppo guarnizione inferiore B9101-21 DX	•	•	•	•	•	•	24
RIC2566/SX	Gruppo guarn inferiore B9102-22-82 SX	•	•	•	•	•	•	24
RIC2566/DX	Gruppo guarn inferiore B9102-22-82 DX	•	•	•	•	•	•	24

Ricambi

Zenith

Codice	Descrizione	Modelli						€
		B9111-15	B9101-07	B9121-27	B9150-53	B9182-87	B9170-73	
RIC2567/SX	Gruppo guarnizione inferiore B9103-23 SX	•	•					24
RIC2567/DX	Gruppo guarnizione inferiore B9103-23 DX			•	•			24
RIC2568/SX	Gruppo guarn inf B9105-07-25-27-87 SX			•	•	•		24
RIC2568/DX	Gruppo guarn inf B9105-07-25-27-87 DX			•	•	•		24
RIC2569/SX	Gruppo guarnizione inferiore B9184-85 SX					•		24
RIC2569/DX	Gruppo guarnizione inferiore B9184-85 DX					•		24
RIC2717	Profilo porta guarnizione B9701-11-21 475 mm	•	•	•				47
RIC2718	Profilo porta guarnizione B9702-12-22-82 543 mm	•	•	•		•		47
RIC2719	Profilo porta guarnizione B9703-13-23 581 mm	•	•	•				47
RIC2720	Profilo porta guarnizione B9784-85 635 mm					•		47
RIC2721	Profilo porta guarnizione B9705-07-15-25-27-87 693 mm	•	•	•		•		47

Grand Polaris

Codice	Descrizione	Modelli			€
		B3750-60	B3705-15	B3720-46	
RIC1098	Gruppo n° 1 guarnizione palloncino		•	•	31
RIC1799	Gruppo viti fissaggio a muro	•	•	•	31
RIC2350	Gruppo guarnizioni magnetiche	•	•	•	40
RIC2351	Gruppo tappi chiusura profilo per magneti	•	•	•	26
RIC2352	Guarnizione fermavetro	•	•	•	28
RIC2353L01	N°1 carter profilo a muro L01		•	•	35
RIC2353ULU	N°1 carter profilo a muro grigio	•	•	•	35
RIC2354L01	Gruppo n°1 maniglia L01		•	•	48
RIC2354ULU	Gruppo n°1 maniglia ULU		•	•	50
RIC2355L01	Gruppo pomelli L01		•	•	35
RIC2355ULU	Gruppo pomelli ULU		•	•	36
RIC2356L01	Gruppo zanca corta L01		•	•	56
RIC2356ULU	Gruppo zanca corta ULU		•	•	61
RIC2357L01	Gruppo zanca lunga L01	•			56
RIC2357ULU	Gruppo zanca lunga ULU	•			63
RIC2359L01	Gruppo n° 2 cerniere complete DX L01		•	•	96
RIC2359ULU	Gruppo n° 2 cerniere complete DX ULU		•	•	113
RIC2360L01	Gruppo n° 2 cerniere complete SX L01		•	•	96
RIC2360ULU	Gruppo n° 2 cerniere complete SX ULU		•	•	113
RIC2361	Gruppo camme cerniere		•	•	34
RIC2362L01	Gruppo terminali vari frangiflutto L01	•	•	•	30
RIC2362ULU	Gruppo terminali vari frangiflutto ULU	•	•	•	42
RIC2363	Gruppo guarnizioni inferiori		•	•	40
RIC2364L01	Profilo a muro L01	•	•	•	62
RIC2364ULU	Profilo a muro ULU	•	•	•	92
RIC2365L01	Profilo a muro lato battuta L01			•	62
RIC2365ULU	Profilo a muro lato battuta ULU			•	92
RIC2366L01	Profilo battuta L01			•	62
RIC2366ULU	Profilo battuta ULU			•	92
RIC2368L01	Profilo frangiflutto L01		•	•	47
RIC2368ULU	Profilo frangiflutto ULU		•	•	55

Ricambi

AcruX

Codice	Descrizione	Modelli					€
		B8816-33	B8801-05	B8812-46	B8852-56	B8822-26	
RIC1341	Gruppo guarn. magnetiche a 180° (1 box)	•	•	•			51
RIC1721	Coppia guarnizioni multipolo (box compl)	•					51
RIC2385ULU	Kit sgancio anta per B7916-23/B7944-48	•	•	•			31
RIC2385L90-L91-L92-L95-L96-L98-L99	Kit sgancio anta L90-L91-L92-L95-L96-L98-L99	•	•	•			31
RIC2387L90-L91-L92-L95-L96-L98-L99	N°1 profilo a muro L90-L91-L92-L95-L96-L98-L99	•	•	•	•	•	74
RIC2388L90/DX - RIC2388L90/SX	N°1 verticale di chiusura DX L90 - N°1 verticale di chiusura SX L90		•	•			61
RIC2388L91/DX - RIC2388L91/SX	N°1 verticale di chiusura DX L91 - N°1 verticale di chiusura SX L91		•	•			61
RIC2388L92/DX - RIC2388L92/SX	N°1 verticale di chiusura DX L92 - N°1 verticale di chiusura SX L92		•	•			61
RIC2388L95/DX - RIC2388L95/SX	N°1 verticale di chiusura DX L95 - N°1 verticale di chiusura SX L95		•	•			61
RIC2388L96/DX - RIC2388L96/SX	N°1 verticale di chiusura DX L96 - N°1 verticale di chiusura SX L96		•	•			61
RIC2388L98/DX - RIC2388L98/SX	N°1 verticale di chiusura DX L98 - N°1 verticale di chiusura SX L98		•	•			61
RIC2388L99/DX - RIC2388L99/SX	N°1 verticale di chiusura DX L99 - N°1 verticale di chiusura SX L99		•	•			61
RIC2388SAR/DX - RIC2388SAR/SX	N°1 verticale di chiusura DX SAR - N°1 verticale di chiusura SX SAR		•	•			61
RIC2388ULU/DX - RIC2388ULU/SX	N°1 verticale di chiusura DX ULU - N°1 verticale di chiusura SX ULU		•	•			61
RIC2425	Guarnizioni verticali con aletta (1 box)	•	•	•			57
RIC2426	N°1 guarn. fermavetro ante fisse	•	•	•			39
RIC2427	N°1 guarnizione verticale a palloncino			•			44
RIC2428	Guarnizioni verticali magnetiche (1 box)		•				55
RIC2429	Guarn gocc. inf B8812-46 (1 box)			•			41
RIC2430	Guarn gocc. inf B8852-56 (1 box)				•		41
RIC2431	Guarn gocc. inf B8801 (1 box)		•				40
RIC2432	Guarn gocc. inf B8802 (1 box)		•				40
RIC2433	Guarn gocc. inf B8803 (1 box)		•				41
RIC2434	Guarn gocc. inf B8804 (1 box)		•				41
RIC2435	Guarn gocc. inf B8805 (1 box)		•				41
RIC2436	Guarn gocc. inf B8807 (1 box)		•				41
RIC2437	Scorrimenti (1 anta)	•	•	•			72
RIC2437L90-L91-L92-L95-L96-L98-L99	Scorrimenti L90-L91-L92-L95-L96-L98-L99 (1 anta)	•	•	•			68
RIC2438	Viti di regolazione verticali (1 box)	•	•	•	•	•	56
RIC2439	Tappi eccentrici e viti (1 box)	•	•	•	•	•	45
RIC2439L90-L91-L92-L95-L96-L98-L99	Tappi eccentrici e viti L90 (1 box) - L91 (1 box) - L92 (1 box) - L95 (1 box) - L96 (1 box) - L98 (1 box) - L99 (1 box)	•	•	•	•	•	42
RIC2440	Angolare frangiflutto	•					34
RIC2441	Angolare binari	•					31
RIC2441L90-L91-L92-L95-L96-L98-L99	Angolare binario L90-L91-L92-L95-L96-L98-L99	•					29
RIC2442	Tasselli fissaggio binari (1 box)	•	•	•	•	•	32
RIC2443	N°1 ammortizzatore	•	•	•			82
RIC2444	Chiave regolazione eccentrico	•	•	•			31
RIC2445	Giunti verticale frangiflutto		•	•			32
RIC2446	Staffa superiore snodo battente		•				106
RIC2446L90-L91-L92-L95-L96-L98-L99	Staffa superiore snodo battente L90-L91-L92-L95-L96-L98-L99		•				104
RIC2447	Staffa inferiore snodo battente		•				96
RIC2447L90-L91-L92-L95-L96-L98-L99	Staffa inferiore snodo battente L90-L91-L92-L95-L96-L98-L99		•				94
RIC2448	Snodo superiore battente		•				18
RIC2449	Snodo inferiore battente		•				99
RIC2449L90-L91-L92-L95-L96-L98-L99	Snodo inferiore battente L90-L91-L92-L95-L96-L98-L99		•				96
RIC2450/DX	N°1 staffa inferiore destra		•				57
RIC2450/SX	N°1 staffa inferiore sinistra		•				57
RIC2451	Coperchio vite svasata m4 CRO	•	•				32
RIC2451L90-L91-L92-L95-L96-L98-L99	Coperchio vite svasata m4 L90-L91-L92-L95-L96-L98-L99	•	•				31
RIC2452	Tappi profili verticali (1 box)	•	•	•	•	•	34
RIC2453	Maniglia esterna e pomolo interno	•	•				71
RIC2453L90-L91-L92-L95-L96-L98-L99	Maniglia esterna e pomolo interno L90-L91-L92-L95-L96-L98-L99	•	•				68
RIC2454	Maniglia interna - esterna			•	•		89
RIC2454L90-L91-L92-L95-L96-L98-L99	Maniglia interna - esterna L90-L91-L92-L95-L96-L98-L99			•	•		87

Ricambi

Pyxis

Codice	Descrizione	Modelli						€
		B1770-79	B1780-89/B1730-99	B1740-49	B1750-59/B1700-69	B1700-09	B1720-29/B1730-39	

Contattare ufficio clienti.

Piatti Doccia

Codice	Descrizione	Modelli								€
		Piatti doccia con foro cm. 5,1	Piatti doccia con foro cm. 9	Piatti doccia con foro cm. 8,5	Piatti doccia con foro cm. 5,2	Piatti doccia Wellness	Piatti doccia Pulplplanet	Piatti doccia Stonefit	Piatti doccia Stone	
RIC534	Piletta griglia cromo-foro cm. 5,1	•								62
RIC822	Piletta tappo cromo-foro piatto cm. 9		•							56
RIC823	Piletta piatti abs - foro piatto cm. 8,5			•						39
RIC824	Piletta tappo cromo-foro piatto cm. 5,2				•		•			41
RIC826	Tubo scarico piletta - l = max cm.100	•	•	•	•	•				23
RIC1445CRO	Griglia cromo foro piatto ø 90		•							30
RIC1446CRO	Griglia cromo foro piatto ø 60			•						25
RIC1583	Piletta piatti wellness					•				56
RIC2346SAT	Copripiletta cromo piatti Stonefit							•		56
RIC1779	Piletta cromo piatti Stonefit				•			•		43
KS3000	Kit scarico piatti Stonefit							•		89
RIC2458R01	Copripiletta cromo piatti Stone R01							•		76
RIC2458R06	Copripiletta cromo piatti Stone R06							•		76
RIC2458R17	Copripiletta cromo piatti Stone R17							•		76
RIC1778SAT	Copripiletta cromo piatti Stone SAT							•		76

Ricambi

Cee Art SP

Codice	Descrizione	Modelli						€
		B0716-23	B0780-90	B0744-48	B0724_29-60-61	B0770-79	B0791-98	
RIC2849	Kit ammortizzatore 15 kg	•	•	•	•	•	•	53
RIC1141	Guarnizioni verticali con aletta (1 box)	•	•	•	•	•	•	36
RIC1802	Gruppo profili magnetici 45° (box comple)	•	•	•	•	•	•	61
RIC1717L01	Gruppo tappi scorr Europa bco (box compl)	•	•	•	•	•	•	23
RIC1717L96	Gruppo tappi scorr Europa bco (box compl)	•	•	•	•	•	•	28
RIC1717L95	Gruppo tappi scorr Cee Art box compl	•	•	•	•	•	•	28
RIC1717G	Gruppo tappi scorr Cee Art grigio box compl	•	•	•	•	•	•	28
RIC2354L91	Gruppo n°1 maniglia L91	•	•	•	•	•	•	50
RIC2354L95	Gruppo n°1 maniglia L95	•	•	•	•	•	•	50
RIC2354L96	Gruppo n°1 maniglia L96	•	•	•	•	•	•	50
RIC2354ULU	Gruppo n°1 maniglia ULU	•	•	•	•	•	•	50
RIC2355L91	Gruppo pomelli L91	•	•	•	•	•	•	36
RIC2355L95	Gruppo pomelli L95	•	•	•	•	•	•	36
RIC2355L96	Gruppo pomelli L96	•	•	•	•	•	•	36
RIC2355ULU	Gruppo pomelli ULU	•	•	•	•	•	•	36
RIC2385L95	Kit sgancio anta L95	•	•	•	•	•	•	31
RIC2385L96	Kit sgancio anta L96	•	•	•	•	•	•	31
RIC2385L01	Kit sgancio anta per b7916-23/b7944-48	•	•	•	•	•	•	30
RIC2385ULU	Kit sgancio anta per b7916-23/b7944-48	•	•	•	•	•	•	31
RIC2383	Guarnizione guida sgancio per b7980-91	•	•	•	•	•	•	40
RIC2728	Viteria di fissaggio	•	•	•	•	•	•	28
RIC1718.G	Gr. Blocca anta business ulu (box compl)	•	•	•	•	•	•	19
RIC1718L96	Gruppo blocca anta (box compl) L96	•	•	•	•	•	•	25
RIC1718L01	Gruppo blocca anta europ bco (box compl)	•	•	•	•	•	•	19
RIC2878L91	Gruppo frangiflutto	•	•	•	•	•	•	35
RIC2878L95	Gruppo frangiflutto	•	•	•	•	•	•	35
RIC2878L96	Gruppo frangiflutto	•	•	•	•	•	•	35
RIC2878ULU	Gruppo frangiflutto	•	•	•	•	•	•	35
RIC2879L91	Gruppo angolare	•	•	•	•	•	•	23
RIC2879L95	Gruppo angolare	•	•	•	•	•	•	23
RIC2879L96	Gruppo angolare	•	•	•	•	•	•	23
RIC2879ULU	Gruppo angolare	•	•	•	•	•	•	23
RIC2880L91	Gruppo fermocorsa	•	•	•	•	•	•	23
RIC2880L95	Gruppo fermocorsa	•	•	•	•	•	•	23
RIC2880L96	Gruppo fermocorsa	•	•	•	•	•	•	23
RIC2880ULU	Gruppo fermocorsa	•	•	•	•	•	•	23
RIC2881	Gruppo scorrimenti	•	•	•	•	•	•	68
RIC2882L91	Profilo a muro s/aletta	•	•	•	•	•	•	58
RIC2882L95	Profilo a muro s/aletta	•	•	•	•	•	•	58
RIC2882L96	Profilo a muro s/aletta	•	•	•	•	•	•	58
RIC2882ULU	Profilo a muro s/aletta	•	•	•	•	•	•	58
RIC2894L91	Profilo a muro	•	•	•	•	•	•	92
RIC2894L95	Profilo a muro	•	•	•	•	•	•	92
RIC2894L96	Profilo a muro	•	•	•	•	•	•	92
RIC2894ULU	Profilo a muro	•	•	•	•	•	•	92
RIC2895L91DX	Gruppo profilo di battuta dx	•	•	•	•	•	•	92
RIC2895L95DX	Gruppo profilo di battuta dx	•	•	•	•	•	•	92
RIC2895L96DX	Gruppo profilo di battuta dx	•	•	•	•	•	•	92
RIC2895LUDX	Gruppo profilo di battuta dx	•	•	•	•	•	•	92
RIC2895L91SX	Gruppo profilo di battuta sx	•	•	•	•	•	•	92
RIC2895L95SX	Gruppo profilo di battuta sx	•	•	•	•	•	•	92
RIC2895L96SX	Gruppo profilo di battuta sx	•	•	•	•	•	•	92
RIC2895LUSX	Gruppo profilo di battuta sx	•	•	•	•	•	•	92
RIC1726L01	Gruppo profili magn 45° bco (box compl)	•	•	•	•	•	•	44
RIC1726ULU	Gruppo profili magn 45° grigio (box compl)	•	•	•	•	•	•	44
RIC2893L91	Gruppo carter profilo a muro	•	•	•	•	•	•	35
RIC2893L95	Gruppo carter profilo a muro	•	•	•	•	•	•	35
RIC2893L96	Gruppo carter profilo a muro	•	•	•	•	•	•	35
RIC2893ULU	Gruppo carter profilo a muro	•	•	•	•	•	•	35

Ricambi

Cee Art

Codice	Descrizione	Modelli							€
		B0924-29	B0916-23	B0980-30	B0944-48	B0901-04	B0930-34	B0907-11	
RIC1128	Monoadesivo	•	•	•				•	19
RIC1266	Gruppo guarnizioni verticali con aletta mm 8	•	•	•					36
RIC1364	Ric guarnizione spazzolino flex							•	23
RIC1620	Gruppo guarnizioni magn 180° (box compl)						•		48
RIC1624	Gruppo guarnizioni magnetiche (1 box completo)				•				46
RIC1626	Gruppo guarnizioni verticali con aletta mm 12							•	50
RIC1715	Gruppo scorrimento EUROPA (1 pz)	•	•	•					30
RIC1717L01	Gruppo tappi scorr EUROPA bianco (box completo)	•	•	•					23
RIC1717ULU	Gruppo tappi scorr EUROPA grigio (box completo)	•	•	•					28
RIC1718L01	Gruppo blocca anta EUROPA bianco (box completo)	•	•	•				•	19
RIC1718ULU	Gruppo blocca anta EUROPA grigio (box completo)	•	•	•				•	25
RIC1726L01	Gruppo profili magn 45° bianco (box completo)		•						44
RIC1726ULU	Gruppo profili magn 45° grigio (box completo)		•						44
RIC1729L01	Gruppo profili magn 180° bianco (box completo)					•			42
RIC1729ULU	Gruppo profili magn 180° grigio (box completo)					•			42
RIC1731	Guarn verticale labbro EUROPA (box completo)					•	•	•	21
RIC1738L01	Gruppo scorrimento tondo bianco (1 pz)							•	28
RIC1738ULU	Gruppo scorrimento tondo grigio (1 pz)							•	28
RIC1739L01	Gruppo sgancio tondo bianco (1 pz)							•	29
RIC1739ULU	Gruppo sgancio tondo grigio (1 pz)							•	29
RIC1798L01	Copriprofilo bianco mm 1950 (box completo)	•	•	•	•	•	•	•	41
RIC1798ULU	Copriprofilo grigio mm 1950 (box completo)	•	•	•	•	•	•	•	42
RIC1799	Sacchetto viti fissaggio a muro	•	•	•	•	•	•	•	31
RIC1800L01	Gruppo fine corsa bianco (4 pz)	•	•	•				•	32
RIC1800ULU	Gruppo fine corsa grigio (4 pz)	•	•	•				•	32
RIC1801L01	Gruppo sgancio bianco (4 pz)	•	•	•					45
RIC1801ULU	Gruppo sgancio grigio (4 pz)	•	•	•					45
RIC1802	Gruppo profili magnetici 45° (box completo)	•							61
RIC1803L01	Gruppo angolare bianco (box completo)	•							34
RIC1803ULU	Gruppo angolare CRO (box completo)	•							40
RIC1804L01	Gruppo snodo battenti bianco (box completo)					•	•		39
RIC1804ULU	Gruppo snodo battenti grigio (box completo)					•	•		39
RIC1805L01	Gruppo snodo soffietto bianco (box completo)							•	34
RIC1805ULU	Gruppo snodo soffietto grigio (box completo)							•	34
RIC1806L01	Gruppo scorrimento soffietto bianco (box completo)							•	42
RIC1806ULU	Gruppo scorrimento soffietto grigio (box completo)							•	42
RIC1807L01	Gruppo cremagliera bianco (box completo)							•	32
RIC1807ULU	Gruppo cremagliera grigio (box completo)							•	32
RIC1808L01	Gruppo maniglia bianco (1pz)	•	•	•	•	•	•	•	35
RIC1808ULU	Gruppo maniglia CRO (1pz)	•	•	•	•	•	•	•	44
RIC2233L01	Profilo a muro aletta CEE ART L01	•	•	•	•	•	•	•	62
RIC2233SAR	Profilo a muro aletta CEE ART SAR	•	•	•	•	•	•	•	92
RIC2233ULU	Profilo a muro aletta CEE ART ULU	•	•	•	•	•	•	•	92
RIC2234L01	Verticale di battuta CEE ART L01					•			62
RIC2234SAR	Verticale di battuta CEE ART SAR					•			92
RIC2234ULU	Verticale di battuta CEE ART ULU					•			92
RIC2235L01	Verticale di snodo CEE ART L01					•	•	•	62
RIC2235SAR	Verticale di snodo CEE ART SAR					•	•	•	92
RIC2235ULU	Verticale di snodo CEE ART ULU					•	•	•	92
RIC2268L01	Profilo a muro CEE ART L01	•							62
RIC2268SAR	Profilo a muro CEE ART SAR	•							92
RIC2268ULU	Profilo a muro CEE ART ULU	•							92
RIC2281L01	Verticale di battuta CEE ART L01		•						62
RIC2281SAR	Verticale di battuta CEE ART SAR		•						92
RIC2281ULU	Verticale di battuta CEE ART ULU		•						92
RIC2323	Guarnizione inferiore gocc (1 pz)					•	•		39

Ricambi

Alter

Codice	Descrizione					€
		B9901 - 17	B9920 - 36	B9941 - 48	B9955 - 56	
RIC871C	Gruppo cerniere CROMO (nr. Pz. 2)		•	•		95
RIC871L01	Gruppo cerniere L01 (nr. Pz. 2)		•	•		89
RIC1080	Gruppo profili magnetici (1 box completo)				•	46
RIC1093	Gruppo profili magnetici (1 box completo)	•	•			46
RIC1098	Gruppo n° 1 guarnizione a palloncino	•			•	31
RIC1102	Gruppo ang. di giunz. x guarniz. A 45°	•	•	•		19
RIC1109	Guarnizione tenuta snodo	•	•	•	•	30
RIC1113	Gruppo tappi x profili a muro	•	•	•	•	19
RIC1199C	Gruppo camme cromo per snodo	•	•	•	•	45
RIC1272C	Gruppo viti	•	•	•	•	19
RIC1353B	Gruppo guarnizione magnetica 180° nicchia bianco				•	42
RIC1353G	Gruppo guarnizione magnetica 180° nicchia grigio				•	42
RIC1354B	Zoccolo frangiflutto BIANCO				•	19
RIC1354G	Zoccolo frangiflutto GRIGIO				•	19
RIC1374L01	Profilo a muro 10446dl1900L01		•	•	•	46
RIC1374ULU	Profilo a muro 10446dp1900ULU		•	•	•	62
RIC1431	Gruppo guarnizione inferiori	•	•	•	•	32
RIC1432ULU	Gruppo frangiflutto L21	•	•	•		30
RIC1433ULU	Gruppo camma centrale	•				29
RIC1434ULU	Gruppo maniglia inferiore e superiore cromo	•				24
RIC1435L01	Gruppo maniglia soffietto bianco		•	•	•	79
RIC1435ULU	Gruppo maniglia soffietto cromo		•	•	•	79
RIC1436L01	Profilo a muro inferiore e superiore L01	•				47
RIC1436ULU	Profilo a muro inferiore e superiore ULU	•				63
RIC1437	Guarnizione con aletta soffietto		•	•		34
RIC1632L01	Profilo a muro 10446dl1875L01				•	46
RIC1632ULU	Profilo a muro 10446dl1875ULU				•	62
RIC1650L01	Cerniera penta L01 (nr. Pz.1)				•	224
RIC1650ULU	Cerniera penta CRO (nr. Pz.1)				•	224
RIC1651ULU	Gruppo frangiflutto L21 Alter penta				•	138
RIC1708L01	Profilo di battuta				•	48
RIC1708ULU	Profilo di battuta				•	53

Flex

Codice	Descrizione	Modelli				€	
		B3512 - 18	B3522 - 44	B3625 - 28	B3532 - 38		B3636 - 38
RIC877	Copri profilo a muro bianco		•	•	•	•	29
RIC1227	Gruppo viti fissaggio a muro	•	•	•	•	•	20
RIC1362	Ric guarnizione inferiore labbro FLEX	•	•	•	•	•	23
RIC1363	Ric guarnizioni primo verticale FLEX	•	•	•	•	•	30
RIC1364	Ric guarnizione spazzolino FLEX	•	•	•	•	•	23
RIC1365L01	Kit guarnizioni calamita nicchia FLEX	•					40
RIC1366L01	Kit guarnizioni calamita angolo FLEX		•	•			40
RIC1367L01	Kit guarnizioni calamita 3 lati FLEX				•	•	40
RIC1368L01	Kit maniglie FLEX	•	•		•		40
RIC1369L01	Kit snodi e camme FLEX	•	•		•		25
RIC1370L01	Kit guarnizione coprifessura FLEX			•		•	23
RIC1409L01	Profilo a muro FLEX L01		•		•		48
RIC1426L01	Profilo a muro FLEX h 100 L01			•		•	41
RIC1427L01	Profilo a muro nicchia FLEX L01	•					41
RIC1428L01	Profilo a muro battuta nicchia FLEX L01	•					40

Ricambi

America Quattro

B6472-18
B6472-79
B6482-97
B6440-54
B6401-07
B6431-37
B6461-67
B6421-29
B6470-73

Codice	Descrizione	Modelli									€
		B6472-18	B6472-79	B6482-97	B6440-54	B6401-07	B6431-37	B6461-67	B6421-29	B6470-73	
RIC2598L91	Gruppo maniglia b.Co	•	•	•	•	•	•			•	39
RIC2598ULU	Gruppo maniglia cro	•	•	•	•	•	•				39
RIC2601	Coppia guarnizioni labbro verticali	•	•	•	•					•	28
RIC627	N°1 gruppo fine corsa			•	•					•	19
RIC895	Gruppo scorrimento	•	•	•	•						19
RIC2728	Viteria di fissaggio	•	•	•	•	•	•	•	•	•	28
RIC2835ULU	Gruppo angolari cromo	•	•	•							25
RIC2835L91	Gruppo angolari bco	•	•	•							25
RIC2836ULU	Gruppo tappi traverso grigi	•	•	•	•						23
RIC2836L91	Gruppo tappi traverso bco	•	•	•	•						23
RIC2837ULU	Gruppo blocchetti ferma anta grigi	•	•	•	•					•	20
RIC2837L91	Gruppo blocchetti ferma anta bco	•	•	•	•					•	20
RIC2838ULU	Profilo a muro angolo ULU	•	•	•							58
RIC2838L91	Profilo a muro angolo L91	•	•	•							58
RIC2637ULU	Coppia magneti				•	•					40
RIC2637L91	Coppia magneti				•	•					40
RIC2850ULU	Profilo a muro ULU				•	•	•	•	•	•	58
RIC2850L91	Profilo a muro L91				•	•	•	•	•	•	58
RIC2851ULU	Prem verticale battuta calamita				•	•					78
RIC2851L91	Prem verticale battuta calamita				•	•					78
RIC1731	Guarn verticale labbro					•	•				21
RIC2860ULU	Prem verticale labbro					•	•				78
RIC2860L91	Prem verticale labbro					•	•				78
RIC2683	Gruppo guarnizione gocciolatoio					•	•				28
RIC2861ULU	Gruppo snodi grigi					•	•				36
RIC2861L91	Gruppo snodi bco					•	•				36
RIC2604	Coppia magneti							•			41
RIC2301ULU	Gruppo cremagliera soffietto grigio								•		31
RIC2301L01	Gruppo cremagliera soffietto L01								•		31
RIC2299ULU	Gruppo snodi soffietto America up grigio								•		28
RIC2299L01	Gruppo snodi soffietto America up L01								•		28
RIC2302	Guarnizione centrale verticale								•		36
RIC2300ULU	Gruppo scorrimento soffietto grigio								•		34
RIC2300L01	Gruppo scorrimento soffietto L01								•		34
RIC2295L01	N°2 fine corsa L01								•		21
RIC2295ULU	N°2 fine corsa grigi								•		21
RIC2296L01	Guarnizione calamita muro L01								•		41
RIC2296ULU	Guarnizione calamita muro grigia								•		41
RIC2297L01	Guarnizione calamita anta L01								•		36
RIC2297ULU	Guarnizione calamita anta grigia								•		36
RIC2866ULU	Prem verticale labbro ULU								•		78
RIC2867ULU	Prem verticale calamita ULU								•		78
RIC2866L91	Prem verticale labbro L91								•		78
RIC2867L91	Prem verticale calamita L91								•		78
RIC2868ULU	Prem profilo centrale								•		57
RIC2868L91	Prem profilo centrale								•		57
RIC2303	Guarnizione inferiore								•		34
RIC1652	Gruppo viti regol. Plastica scor. L01/ULU									•	20
RIC2727	Coppia magneti									•	36
RIC2873ULU	Gruppo scorrimento inf/sup grigio									•	40
RIC2873L91	Gruppo scorrimento inf/sup bco									•	40
RIC2874	Gruppo blocca magneti									•	18
RIC2298ULU	Guarnizione labbro muro grigia								•		34
RIC2298L01	Guarnizione labbro muro L01								•		34

Ricambi

America Quattro SP

Codice	Descrizione	Modelli						€
		B6372-19	B6372-78	B6382-98	B6331-37	B6340-58	B6363-69	
RIC2594ULU	Gruppo angolare cromo	•	•	•				26
RIC2594L91	Gruppo angolare bco	•	•	•				26
RIC2595ULU	Gruppo tappi binario grigio	•	•	•		•	•	21
RIC2595L91	Gruppo tappi binario bco	•	•	•		•	•	21
RIC2596	Gruppo scorrimento	•	•	•		•	•	45
RIC1800ULU	Fermo corsa in gomma grigio	•	•	•		•	•	32
RIC1800L91	Gruppo fine corsa b.Co	•	•	•		•	•	32
RIC2597ULU	Gruppo ferma anta grigio	•	•	•		•	•	20
RIC2597L91	Gruppo ferma anta b.Co	•	•	•		•	•	20
RIC2598ULU	Gruppo maniglia cro	•	•	•	•	•	•	39
RIC2598L91	Gruppo maniglia b.Co	•	•	•	•	•	•	39
RIC2599ULU	Gruppo sgancio frontale cro	•	•	•		•	•	40
RIC2599L91	Gruppo sgancio frontale b.Co	•	•	•		•	•	40
RIC2600ULU	Gruppo sgancio anta cro	•	•	•		•	•	34
RIC2600L91	Gruppo sgancio anta b.Co	•	•	•		•	•	34
RIC2601	Coppia guarnizioni labbro verticali	•	•	•		•	•	28
RIC2602	Coppia guarnizioni guida sgancio 4mm	•	•	•		•	•	36
RIC2603	Sacchetto viti di fissaggio	•	•	•	•	•	•	23
RIC2604	Coppia magneti	•	•	•	•	•	•	41
RIC2605ULU	Profilo a muro ULU					•	•	78
RIC2605L91	Profilo a muro L91					•	•	78
RIC2605SAR	Profilo a muro SAR					•	•	78
RIC2635L91	Frangiflutto L91 b6395-43			•		•		31
RIC2636L91	Frangiflutto L91 b6396-97-98	•	•	•				31
RIC2637ULU	Coppia magneti					•		40
RIC2637L91	Coppia magneti					•		40
RIC2639ULU/DX	Prem verticale chiusura p2a dx					•		78
RIC2639L91/DX	Prem verticale chiusura p2a dx					•		78
RIC2639SAR/DX	Prem verticale chiusura p2a dx					•		78
RIC2639ULU/SX	Prem verticale chiusura p2a sx					•		78
RIC2639L91/SX	Prem verticale chiusura p2a sx					•		78
RIC2639SAR/SX	Prem verticale chiusura p2a sx					•		78
RIC2680ULU	Gruppo snodi grigio					•		36
RIC2680L91	Gruppo snodi b.Co					•		36
RIC1731	Guarn verticale labbro					•		21
RIC2681ULU/SX	Prem verticale labbro sx ULU					•		78
RIC2681L91/SX	Prem verticale labbro sx L91					•		78
RIC2681SAR/SX	Prem verticale labbro sx SAR					•		78
RIC2681ULU/DX	Prem verticale labbro dx ULU					•		78
RIC2681L91/DX	Prem verticale labbro dx L91					•		78
RIC2681SAR/DX	Prem verticale labbro dx SAR					•		78
RIC2682ULU/SX	Prem verticale battuta sx ULU					•		78
RIC2682L91/SX	Prem verticale battuta sx L91					•		78
RIC2682SAR/SX	Prem verticale battuta sx SAR					•		78
RIC2682ULU/DX	Prem verticale battuta dx ULU					•		78
RIC2682L91/DX	Prem verticale battuta dx L91					•		78
RIC2682SAR/DX	Prem verticale battuta dx SAR					•		78
RIC2683	Gruppo guarnizione gocciolatoio					•		28
RIC2722ULU	Profilo a muro ULU	•	•	•				78
RIC2722L91	Profilo a muro L91	•	•	•				78
RIC2722SAR	Profilo a muro SAR	•	•	•				78

Ricambi

America

Codice		Modelli											€				
		B6816-23	B6835-37	B6830-99	B6826-29	B6831-34	B6841-08	6844-45	6870-95 TH-ST	6870-95 JUIA	B6870-72	B6893-95		6819-21			
RIC987L01	Gruppo guarnizione coprifessura	•					•	•	•								20
RIC1036L01	Gruppo guarnizioni				•												45
RIC1038	Gruppo scorrimento				•												36
RIC1039	Gruppo snodo				•												21
RIC1064L01	Gruppo pomello completo (solo vetro)								•								21
RIC1372L01	Gruppo guarnizioni tondi								•	•							71
RIC1373L01	Gruppo guarnizioni tondi								•	•							36
RIC1376L01	Gruppo cerniere				•												20
RIC1377L01	Gruppo guarnizioni verticali		•		•												30
RIC1378L01	Gruppo guarnizioni orizzontali		•		•												30
RIC1380L01	Gruppo snodo 1 anta		•		•												23
RIC1410L01	Profilo a muro	•															48
RIC1411L01	Profilo giunzione															•	71
RIC1599L01	Gruppo calamite		•		•			•									46
RIC1799	Sacchetto viti fissaggio a muro	•	•		•	•		•	•	•						•	31
RIC2225L01	Gruppo guarnizioni	•															29
RIC2816L01	N° 1 profilo a muro		•		•	•		•	•	•							62
RIC2817	Gruppo scorrimento 1 anta	•						•									55
RIC2818L01	Gruppo angolare (box completo)	•															24
RIC2819L01	Gruppo fine corsa (4 pz)	•						•	•	•							18
RIC2820L01	Gruppo guarnizioni magnetiche																35
RIC1600L01	Gruppo scorrimenti												•	•			28
RIC1630L01	Gruppo magneti		•		•												39
RIC1641L01	Gruppo sgancio anta																24
RIC1652	Gruppo viti regolazione plastica scor.												•	•			20
RIC1680L01	Tappi copri foro scorrimento	•		•				•	•								19
RIC1709L01	Profilo di battuta		•					•									60
RIC1799	Sacchetto viti fissaggio a muro							•									31
RIC2188L01	Profilo verticale nicchia 2a soffietto B6831-34							•									62
RIC2284L01	Gruppo scorrimento soffietto							•									44
RIC2285L01	Gruppo scorrimento soffietto							•									34
RIC2294L01	Gruppo guarnizioni centrali							•									39
RIC2295L01	N°2 fine corsa							•									21
RIC2296L01	Guarnizione calamita muro							•									41
RIC2297L01	Guarnizione calamita anta							•									36
RIC2298L01	Guarnizione labbro muro							•									34
RIC2299L01	Gruppo snodi soffietto							•									28
RIC2300L01	Gruppo scorrimento soffietto							•									34
RIC2301L01	Gruppo cremagliera soffietto							•									31
RIC2302	Guarnizione centrale verticale							•									36
RIC2303	Guarnizione inferiore							•									34
RIC2304L01	Profilo verticale L01 nicchia 2a soffietto B6831-34							•									62
RIC2309L01	Verticale centrale soffietto							•									62
RIC2726L01	Coppia maniglie	•		•				•	•			•	•				28
RIC2727	Coppia magneti	•		•				•	•			•	•				36
RIC2728	Viteria di fissaggio	•		•				•	•			•	•				28
RIC2729L01	Gruppo profilo di battuta P2A							•									62
RIC2730L01	Magnete battuta							•									34
RIC627	N°1 Gruppo fine corsa	•	•	•	•	•	•	•	•			•	•				19
RIC874	Gruppo guarnizioni verticali		•		•												21
RIC875	Gruppo guarnizioni orizzontali		•		•												31
RIC876	Gruppo guarnizioni calamitate							•									36
RIC877	Copriprofilo a muro		•		•	•	•	•	•							•	29
RIC878	Gruppo snodo completo (1 box completo)		•		•												20
RIC879	Tappi profilo a muro	•	•	•	•	•	•	•	•			•	•	•			19
RIC880	Sacchetto viti fissaggio a muro		•		•	•										•	14
RIC892	Gruppo guarnizioni (1 box completo)	•		•				•	•								19
RIC894	Gruppo angolare	•		•													20
RIC895	N°1 scorrimento	•		•				•	•								19
RIC896	Gruppo guarnizioni (1 box completo)											•	•				29
RIC901	Gruppo guarnizioni (1 box completo)							•									30
RIC1212	Gruppo snodo completo (1 box completo)							•									24

Ricambi

America

Codice	Descrizione	Modelli											€				
		B6816-23	B6835-37	B6830-99	B6826-29	B6831-34	B6841-08	6844-45	6870-95 TRF-ST	6870-95 JUTA	B6870-72	B6893-95		6819-21			
RIC1315G	Gruppo scorrimento					•											35
RIC1376L01	Gruppo cerniere					•											20
RIC1409L01	Profilo verticale a muro	•		•		•	•	•									48
RIC1410L01	Profilo verticale a muro	•		•								•	•				48
RIC1411L01	Profilo montante verticale di giunzione													•			71

Ciao

Codice	Descrizione	Modelli			€
		B2801-10	B2860-67	B2870-76	
RIC845	Sacchetto viti fissaggio a muro	•	•	•	20
RIC987L01	Gruppo guarnizione coprifessura	•			20
RIC988	Gruppo guarnizioni calamitate	•			31
RIC1036L01	Gruppo guarnizioni		•		45
RIC1038L01	Gruppo scorrimento		•		36
RIC1039L01	Gruppo snodo		•		28
RIC1371L01	Gruppo angolare	•			23
RIC1376L01	Gruppo cerniere		•		20
RIC1385L01	Profilo a muro h=1850	•	•	•	40
RIC1387L01	Profilo montante giunzione h=1850			•	48

Pareti Vasca

Codice	Descrizione	Modelli							€
		B1650-1660	B1670-1672	B1696-1697	B1698-1698	B1699	B1382-84-85	B1390-93	
RIC1184	Gruppo guarnizione orizzontale	•	•	•					40
RIC1186C	Gruppo camme DREAM	•	•	•	•				45
RIC1187	Gruppo guarnizione snodo	•	•	•	•				28
RIC1190	Gruppo guarnizione orizzontale		•						20
RIC1192L01	Carter di copertura viti BIANCO	•	•	•	•				30
RIC1192ULU	Carter di copertura viti ULU	•	•	•	•				41
RIC1194L01	Carter di copertura viti BIANCO					•			31
RIC1194ULU	Carter di copertura viti ULU					•			44
RIC1227	Gruppo viti fissaggio a muro						•	•	20
RIC1271C	Gruppo camme snodo		•						77
RIC1362	Guarnizione inferiore a labbro						•		23
RIC1363	Guarnizione per primo profilo verticale						•		30
RIC1369L01	Kit snodi e camme FLEX						•		25
RIC1429L01	Profilo verticale a muro						•	•	36
RIC1537L01	Maniglione per parete vasca		•						57
RIC1537ULU	Maniglione per parete vasca		•						96
RIC1696L01	Profilo a muro B1650-B1660 L01	•							52
RIC1696ULU	Profilo a muro B1650-B1660 ULU	•							63
RIC1700ULU	Profilo a muro B1670-72-89-96-97-B1480-90		•	•	•				53
RIC1911L01	Profilo a muro						•		47
RIC1911ULU	Profilo a muro						•		60

Servizi pre e post-vendita

Samo dispone in tutta Italia di una rete di Centri Assistenza a pagamento con tariffario convenzionale formata da personale specializzato per installazione, montaggio e manutenzione dei prodotti Samo.

Samo esaudisce le aspettative dei propri clienti, dei professionisti del settore, installatori e strutture di vendita e degli utenti finali, con velocità e precisione per scegliere e mantenere efficienti nel tempo i prodotti Samo e risolvere i quesiti che emergono.

Ogni Centro Assistenza può essere interpellato direttamente dal rivenditore o dall'utilizzatore finale.

Per conoscere il Centro Assistenza più vicino si può interpellare l'agente di zona, oppure consultare il sito www.samo.it.



Condizioni di fornitura

- A. Le cabine devono trovarsi all'interno del vano di installazione o nelle immediate vicinanze.
- B. Gli imballi devono essere posti all'interno dello stabile prestabilito per l'installazione.
- C. La predisposizione e l'allacciamento degli impianti idrico/elettrici sono a cura della committenza. (devono essere idonei alle cabine da installare ed in regola con le normative di legge vigenti).
- D. Eventuale posizionamento del piatto doccia dovrà essere a cura della committenza (idoneo per forma, dimensioni e posa e congruenti con il tipo di cabina da installare).
- E. La data di inizio lavori richiesta deve essere comunicata dalla committenza con 10 giorni di anticipo, previa vostra verifica delle condizioni dei locali e della disponibilità del materiale da installare.
- F. L'acquirente si impegna a garantire la continuità della fase di installazione dei prodotti a partire dalla data comunicata.
- G. I locali interessati dovranno essere accessibili e sgombri (nella zona specifica) da accessori, sanitari, mobili, torelli, etc. che impediscano l'installazione delle cabine doccia e dotati di presa funzionante da 220 V.
- H. L'acquirente si impegna a fornire la mappatura completa riguardante la suddivisione delle cabine doccia per piano/camera in fase di acquisto.
- I. L'acquirente solleva il Centro Assistenza Samo da qualsiasi responsabilità dovuta al danneggiamento di impianti presenti nelle zone di installazione se non anticipatamente comunicato tramite l'invio della mappatura impianti con 10 giorni di anticipo.
- J. A lavori di installazione ultimati verrà effettuato il controllo dal responsabile dei lavori o da un incaricato da voi scelto che si impegnerà a firmare il Rapporto di Intervento Samo.
- K. In caso di interventi straordinari non previsti e concordati preventivamente, saranno addebitati, a lavori ultimati, al costo fisso di 50 €/ora per tecnico.
- L. Le tipologie di offerta per installazione/smontaggio cabine non comprendono lo smaltimento degli imballi o delle cabine obsolete se non preventivamente concordato in fase d'offerta.
- M. Per foratura su materiali tipo Gres porcellanato, marmo, vetro, verrà applicato un aumento di € 50.
- N. Le pareti interessate al posizionamento delle cabine devono essere idonee per dimensioni e struttura per l'ancoraggio delle stesse come da istruzioni di montaggio, in caso contrario deve essere comunicato dal responsabile dei lavori con 10 giorni di anticipo.
- O. In caso di impossibilità di montaggio, verrà addebitata l'uscita di € 110.

Servizi pre e post-vendita

Codice	Operazione	Descrizione	(€)	
KU4000.01	Rilevazione misure	Uscita e rilevazione delle misure	80	
KU7000.01	Montaggio cabina doccia	Uscita e installazione 1 parete	da 0 a 100 cm	145
KU7000.11	Montaggio cabina doccia	Uscita e installazione 1 parete	da 100 a 200 cm	200
KU7000.03	Montaggio cabina doccia	Uscita e installazione 2 pareti	da 0 a 100 cm	180
KU7000.33	Montaggio cabina doccia	Uscita e installazione 2 pareti	da 100 a 200 cm	240
KU7000.10	Montaggio cabina doccia	Uscita e installazione 3 pareti	da 0 a 100 cm	250
KU7000.20	Montaggio cabina doccia	Uscita e installazione 3 pareti	da 100 a 200 cm	290
KU7000.09	Montaggio Pareti vasca, piatti doccia	Uscita e installazione		120
Servizi Omnicomprensivi nel raggio di 30 Km dalla sede del Centro Assistenza Scelto.			//	
Interventi straordinari non previsti e concordati preventivamente *K		costo fisso per 1 ora	50	
Per foratura su materiali tipo Gres porcellanato, marmo, vetro *M		aumento di	50	
Uscita a vuoto per l'impossibilità di montaggio *O		addebito dell'uscita	110	

* Vedi Condizioni di fornitura

N.B. Servizi da concordare con i Centri Assistenza (i prezzi sono netti (senza IVA) ed indicativi, espressi in €).

Servizi Erogati

Assistenza pre-installazione
 Rilevazione misure
 Personalizzazioni grafiche delle cabine doccia
 Soluzioni Speciali

Assistenza durante l'installazione
 Smontaggio cabine doccia esistenti
 Identificazione e distribuzione imballi
 Montaggio nuove cabine doccia
 Smaltimento imballi cabine doccia installate
 Smaltimento cabine doccia sostituite
 Primo avviamento

Assistenza POST-installazione
 Manutenzione ordinaria
 Manutenzione straordinaria
 Fornitura ricambi

Qualità



samo, da sempre, ha fatto proprio il concetto di Qualità, una qualità che coinvolge ogni fase del proprio processo aziendale. Prima Azienda del settore ad ottenere la certificazione ISO 9000 nel 1994, **samo** ha continuato il proprio percorso che si è arricchito via via di fondamentali passaggi all'insegna della Qualità Totale, dalla scelta dei fornitori, alla ricerca di nuove tecnologie e nuovi materiali, allo sviluppo di innovativi progetti attraverso processi produttivi all'avanguardia sino al servizio ed alla qualificata assistenza alla clientela. Il marchio di Qualità **samo** contraddistingue questi significativi passaggi e costituisce un punto fermo ed una solida garanzia nell'intera filiera, per un risultato finale affidabile e duraturo.

Brevetti

Brevetto per Modello d'utilità per Colonna PICTOR Ns. codice KR3000 (N° VR2008U000020):

domanda di brevetto per Modello d'utilità N. VR2008U000020 relativo ad una "colonna attrezzata per zona doccia o bagno" depositata in data 26.09.2008 [DOM. MOD. UT. N.VR2008U20].

Brevetto per invenzione industriale (N° VR2009A000060)

domanda di brevetto per invenzione industriale N. VR2009A000060 dep. il 29/4/2009 relativa a "Cabina doccia"

Brevetto per invenzione industriale (N° VR2009A000148)

domanda di brevetto per invenzione industriale N. VR2009A000148 dep. il 28/9/2009

relativa a "Montante di supporto per un pannello, particolarmente per pannelli di chiusura di box doccia"

Brevetto per invenzione industriale (N° VR2011A000182)

domanda di brevetto per invenzione industriale N. VR2011A000182 dep. il 20/09/2011

relativa a "Elemento allungato di supporto per un pannello di chiusura di box doccia".

Brevetto per invenzione industriale (N° VR2011A000183)

domanda di brevetto per invenzione industriale N. VR2011A000183 dep. il 20/09/2011 relativa a "Struttura di imballo".

Cabine doccia

Le cabine doccia di **samo** sono conformi alla Direttiva Europea 89/106/CEE (Prodotti da Costruzione) e successive modifiche introdotte con la Direttiva Europea 93/68/CEE. L'attuazione delle suindicate Direttive è garantita dall'applicazione da parte di SAMO della norma armonizzata EN14428:2015 (Pareti doccia – Requisiti funzionali e metodi di prova).

In particolare la norma EN14428:2015 richiede la verifica sul prodotto mediante idonee prove delle caratteristiche di pulibilità, resistenza all'urto, resistenza alla corrosione, resistenza agli agenti chimici e alle macchie, resistenza ai cicli umido / secco, durata ai cicli di apertura / chiusura ante, stabilità secondo norma ISO7892:1988 e tenuta all'acqua.

• Dichiarazione di Conformità **EN14428:2015**: disponibile nel nostro sito internet www.samo.it



Materiali

• ALLUMINIO:

ì profili di alluminio sono realizzati con materiale primario di altissima qualità. L'alluminio con elevata resistenza alla corrosione è un materiale in grado di tradurre idee e progetti grazie all'estrusione che si ottiene tramite matrici progettate dall'Area Prodotto **samo** e di proprietà esclusiva **samo**. Ogni singolo profilo è preventivamente tagliato e forato, permettendo così ai successivi trattamenti di coprire ogni parte del pezzo, garantendo una qualità duratura nel tempo. La verniciatura viene effettuata attraverso gli impianti tecnologici **samo**; ogni profilo subisce un pretrattamento di sgrassaggio e fosfocromatazione prima di essere verniciato con polveri epossidiche le quali, applicate elettrostaticamente su tutta la superficie del profilo, polimerizzano formando uno strato resistente ed inalterabile nel tempo. Brillantatura e satinatura sono ottenute a mezzo di processi chimici preceduti da accurata spazzolatura dei profili per renderli resistenti e duraturi nel tempo.

• OTTONE:

è una lega rame-zinco, che presenta notevoli caratteristiche di lavorabilità sia a caldo che a freddo. Viene infatti utilizzata per la produzione di barre e trafilati oppure per particolari lavorati. Grazie alla sua ottima predisposizione alla cromatura, garantisce un prodotto di qualità costante nel tempo.

• POLYSTYRENE:

è all'origine granulato. Scaldandosi ad alta temperatura con un impianto di estrusione si crea un pannello robusto, leggero e con un alto indice di resistenza alla flessione. L'impianto di estrusione è dotato di cilindri su cui sono incisi vari decori **samo** che s'imprimono sul pannello.

• STONEFIT-STONE:

è un materiale composito, formato da cariche minerali naturali e resina. E' rivestito da un coating ad effetto estetico opaco. Questo rivestimento abbina ottime caratteristiche di resistenza a completa ripristinabilità della superficie. Tale prodotto è realizzato con materiali tecnologicamente all'avanguardia e dall'elevato impatto estetico: l'alta capacità di resistenza ai graffi e all'abrasione ne permette l'uso quotidiano e garantisce nel tempo la finitura opaca originale, caratteristica distintiva di STONEFIT, può essere riparato da danneggiamenti superficiali, quali graffi o macchie ostinate, riportando la superficie alla bellezza originale. Si consiglia l'impiego di detergenti in gel o abrasivi e spugna abrasiva tipo Scotch Brite®. Alcune sostanze chimiche possono danneggiare la superficie del piatto doccia STONEFIT: si sconsiglia quindi l'uso di acidi e basi forti (acido cloridrico, soda caustica), chetoni (acetone), solventi clorurati (trielina) e prodotto usati nel settore della verniciatura.

• MATERIALE ACRILICO:

è leggero, con superficie sempre lucida e brillante con colori inalterati ed un altissimo grado di isolamento termico. Il materiale viene lavorato con un particolare procedimento di stampaggio a caldo per dare forma al prodotto con impianti di termoformatura all'interno degli stabilimenti **samo**. Il prodotto è poi rinforzato con una speciale resina di poliesteri e vetroresina che lo rende resistente e durevole nel tempo.

• ELEMENTI DI FISSAGGIO E RACCORDO:

sono studiati e realizzati nei materiali più adatti per garantire durata e qualità (acciaio, nylon, abs, teflon, ottone, zama). Sistemi di scorrimento e guide speciali sono garantite per una perfetta chiusura e tenuta d'acqua.

StarClean

• **VETRO TEMPRATO:** viene ottenuto per indurimento tramite trattamento termico. Il vetro, prima del processo di tempra, va tagliato rispettando le dimensioni richieste e vanno eseguite tutte le necessarie lavorazioni come la levigatura degli spigoli, le forature e le svasature.

Il vetro viene poi posto su un tavolo a rulli sui quali scorre all'interno di un forno, dove viene opportunamente portato alla temperatura di tempra di 640 °C ed eventualmente viene curvato. Immediatamente all'uscita del forno il vetro viene bruscamente raffreddato da getti di aria fredda ad alta pressione, raffreddando così gli strati superficiali causandone l'indurimento ed il conseguente irrigidimento, mentre la parte interna rimane calda più a lungo. Il successivo raffreddamento della parte interna produce uno sforzo di compressione sulla superficie del vetro, bilanciato da tensioni distensive in trazione nella parte interna. La formazione di questo stato permanente di tensione causa un assorbimento di energia elastica da parte del vetro; quando un vetro temprato si rompe, l'energia immagazzinata viene liberata sotto forma di energia superficiale e per tale motivo alla rottura si formano frammenti piccoli e non taglienti, al contrario di quanto si verifica quando si rompe di un vetro ordinario dove si formano grandi frammenti, anche lanceolati, taglienti e molto pericolosi.

Per questa ragione il vetro temprato è considerato "vetro di sicurezza" e questa caratteristica è ampiamente sfruttata nell'industria automobilistica, dove viene impiegato per realizzare i finestrini laterali delle automobili, ed in generale in tutte quelle applicazioni dove i frammenti del vetro infranto potrebbero colpire delle persone, ad esempio nelle porte in vetro nelle applicazioni strutturali e nelle zone parapetto.

In alcune situazioni però si possono riscontrare problemi di sicurezza a causa della tendenza del vetro temprato di frantumarsi completamente a seguito di urti. È pertanto necessario che la lastra in vetro venga maneggiata con molta cura.

Se dovesse essere necessario appoggiare il vetro al pavimento va fatto con molta cautela, evitando di appoggiarlo sugli spigoli, ma posandolo delicatamente su tutta la lunghezza del lato. È inoltre indispensabile interporre uno strato morbido fra il vetro ed il pavimento (per esempio il cartone dell'imbollo).

Perché scegliere il trattamento con metodo StarClean

- **StarClean è solo samo:** l'azienda ha integrato l'esclusivo trattamento nel proprio processo produttivo ottimizzando risultati in termini di qualità-prezzo.
- **StarClean è specifico per vetri di cabine doccia:** agisce sulle molecole di silicio contenute nel vetro.
- **StarClean è sicuro:** la tecnologia adottata garantisce sempre l'ottima performance del trattamento effettuato.
- **StarClean è idrorepellente:** è applicato su ambedue le superfici del pannello; l'acqua scivola via e rende le operazioni di pulizia molto più semplici ed efficaci; con una **semplice asciugatura SUBITO dopo l'utilizzo** si evitano formazioni di aloni o macchie.
- **StarClean NON è autopulente.**
- **StarClean è anticalcare:** l'acqua, scivolando via, riduce notevolmente la formazione di calcare; le eventuali tracce rimanenti sono facili da togliere poichè non riescono ad aderire alla superficie del vetro.
- **StarClean è antigraffio:** il trattamento rende le superfici del vetro più resistenti ai graffi.
- **StarClean è resistente agli urti:** il trattamento rende le superfici del vetro più resistenti agli urti.
- **StarClean è più brillante:** il trattamento rende le superfici del vetro più brillanti.
- **StarClean è standard oppure optional:** è così richiesto che è già standard su molte serie di box doccia. **samo** comunque è in grado di offrire **StarClean** come optional anche nelle altre gamme di prodotto per rendere una scelta conveniente.
- **StarClean è personalizzabile:** ha la possibilità di personalizzazione con marchio. Il marchio diventa visibile solo durante l'utilizzo del box doccia (come immagine PERSONALIZZAZIONE).

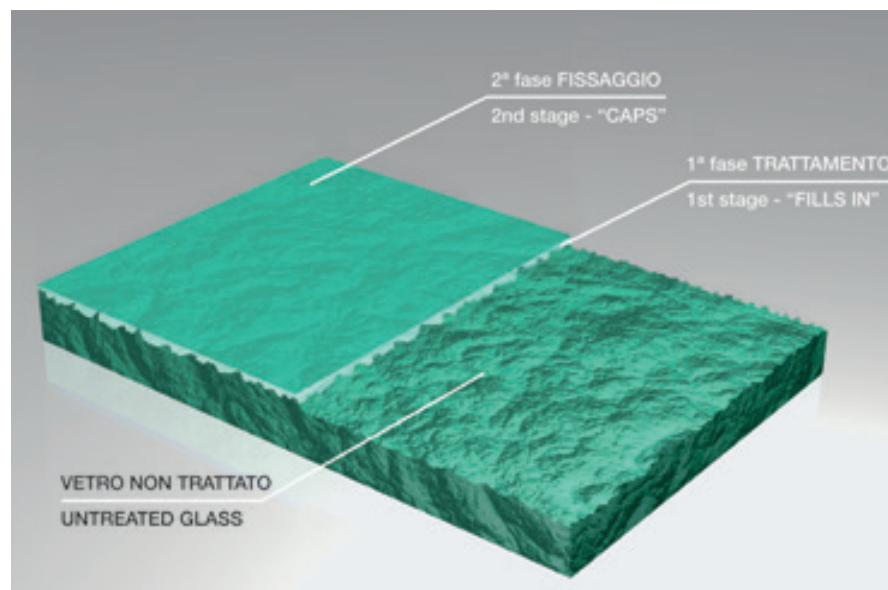

AZIONE DEL TRATTAMENTO

Sottile barriera creata con approvata azione chimica, con effetto idrorepellente.

Pulizia dei prodotti

PREMESSA

Poiché nessun materiale è perfettamente resistente a qualsiasi agente pulente che normalmente si trova in commercio, la NON OSSERVANZA delle seguenti istruzioni può essere oggetto di DECADIMENTO della GARANZIA dei Prodotti Samo.

AVVERTENZE GENERALI

- LEGGERE attentamente le etichette dei prodotti detergenti che utilizzerete per la pulizia e la cura delle cabine doccia Samo.
- NON USARE prodotti che riportano etichette non chiare o incomplete.
- CONSERVARE per qualche mese le confezioni dei prodotti che utilizzate per eventuali verifiche e/o contestazioni.

MODALITÀ DI SCELTA DEI PRODOTTI DETERGENTI

• NON USARE i prodotti di seguito indicati

- a) Prodotti Corrosivi, quali prodotti a base di Cloro (Ipocloriti e similari quali i candeggianti).
- b) Prodotti a base di Ossigeno Attivo (ad esempio i Perborati).
- c) Prodotti a base Acida (quali Acido Cloridrico (muriatico), Acido Nitrico o Nitrati, Acido Fluoridrico o Fluoruri).
- d) Prodotti a base di Soda e, in generale, prodotti caratterizzati da valori di pH inferiori a 6 e maggiori di 8.
- e) Prodotti abrasivi e/o in polvere poiché possono danneggiare meccanicamente ed irrimediabilmente la cabina doccia.

• USARE i prodotti di seguito indicati

- a) Prodotti detergenti del tipo delicato, contenenti esclusivamente tensioattivi, anche a base di Fosfati, caratterizzati da valori di pH compresi fra 6 ed 8.
- b) Nel caso di incrostazioni dovute alla presenza di acque dure, è consigliabile l'uso di prodotti a base di aceto con valori di pH vicino a 5.

In questo caso leggere attentamente le istruzioni di seguito descritte.

- Procedere alle operazioni di pulizia non appena possibile e comunque dopo l'uso della cabina doccia; ciò allo scopo di evitare il formarsi di incrostazioni ed indurimenti dello sporco.
- Utilizzare sempre acqua tiepida e spugne delicate o panni morbidi.
- Risciacquare sempre con acqua tiepida.
- Asciugare le parti metalliche sempre con un panno morbido (ad esempio in microfibra).

• NOTA IMPORTANTE

Dopo l'uso dei detergenti e l'asciugatura della cabina doccia, si raccomanda di far circolare aria fresca(*) nell'ambiente in cui è posizionata la cabina doccia, anche e soprattutto all'interno della cabina doccia stessa; ciò allo scopo di permettere al materiale di mantenere un buon grado di "autoprotezione" nei confronti di fenomeni di ossidazione. Questo è particolarmente importante nel caso di cabine doccia "chiuse".

(*) Per aria fresca non si intende aria fredda ma aria non viziata.



PULIZIA

Con una semplice asciugatura subito dopo l'utilizzo si evitano formazioni di aloni o macchie



PERSONALIZZAZIONE

e-samo

e-samo rientra nel novero dei servizi ad alto valore aggiunto che Samo offre ai propri clienti come sviluppo della partnership. In un mondo dove l'accesso istantaneo alle informazioni è diventato una variabile dominante, e-samo è lo strumento creato da Samo attraverso il quale ogni cliente ha la possibilità di accedere alle informazioni in modo tempestivo ed esaustivo, garantendo la professionalità e migliorando il servizio al consumatore finale. Grazie a questa piattaforma web, e-samo permette agli utenti di poter accedere al processo completo di gestione dei propri ordini, dall'inserimento dell'ordine d'acquisto, al controllo della disponibilità degli articoli, al monitoraggio dello stato sino all'interazione diretta con il personale interno.



web services

Il portale è il punto di partenza nel network dei servizi e-samo, una porta spalancata verso il mondo delle informazioni disponibili in Samo. Tramite un unico punto di ingresso Rivenditori, Agenti, e Centri Assistenza possono raggiungere una vasta quantità di contenuti, informazioni, servizi e applicazioni. Il portale Samo assolve tre importanti funzioni:

- * permette l'inserimento veloce degli ordini d'acquisto;
- * aggrega ed organizza l'enorme quantità di dati generati e diffusi all'interno dell'azienda presentandoli come informazioni agli utenti attraverso un'interfaccia web intuitiva.
- * Mette in contatto tutti i protagonisti della filiera permettendo loro di dialogare direttamente.

I vantaggi che Samo si propone di realizzare per tutti i clienti sono:

- * migliore capacità decisionale attraverso l'accesso a informazioni aggregate, residenti su sistemi diversi e in differenti posizioni fisiche;
- * coerente visione dell'organizzazione informativa aziendale che permette ai clienti una facile individuazione delle informazioni attraverso una singola e intuitiva interfaccia;
- * collegamenti diretti a report, analisi, query e dati relativi ad informazioni acquisite.

Per saperne di più collegati al portale: <https://portal.samospa.net:4430/SAMO>
oppure scrivi alla mail: portal@samo.it

I NOSTRI SERVIZI

Disponibilità degli articoli on-line

**Da Portale,**

questa funzione permette di controllare la disponibilità degli articoli a magazzino prima di effettuare un ordine. Per conoscere tale disponibilità, inserire il codice prodotto, meglio se seguito dal carattere jolly * (asterisco): in questo modo la ricerca verrà ampliata a tutte le varianti.

Via e-mail

Lo stesso controllo degli articoli è disponibile anche via mail: giacenza-it@samo.it
esempio di come deve essere inviata una richiesta, inserendo nel corpo della mail (non nell'oggetto) il codice richiesto come segue :B7823*; (quindi codice anche non completo + asterisco * + punto e virgola ;

Inserimento degli ordini d'acquisto

**Differenti modalità di inserimento ordini**

L'inserimento ordini può essere eseguito in due modalità principali, a seconda delle necessità dell'utente.

* Diretta: inserimento dal Portale

* EDI: scambio di file digitali tra diversi sistemi gestionali

Stato degli ordini on-line

**Da Portale in una unica pagina è possibile:**

* tenere traccia dei propri ordini in produzione/spedizione

* con un click approfondire l'analisi verificando la presenza di ritardi o blocchi

Via e-mail

Lo stesso servizio di controllo dello stato degli ordini è disponibile anche via mail.

Monitoraggio e controllo degli ordini

**Da Portale, questa funzione permette di controllare:**

* Stato dei tuoi ordini: stato generale degli articoli in produzione/spedizione

* Rintracciabilità: ricerca dettagliata all'interno dello stato

* Flusso documento: connessione tra Ordine, Bolla e Fattura e stampa del pdf relativo

* Gestione Resi: visualizzazione dei resi effettuati con tutti i riferimenti

* Ordini EDI: storico ordini trasmessi via EDI

* Analisi statistica sugli storici dell'ordinato/fatturato con confronti sino a tre anni in linea

Supporto agli utenti

**Collaboration-CHAT**

Gli utenti connessi al portale hanno la possibilità di contattare via CHAT, in tempo reale, i propri referenti tecnici e commerciali Samo.

Teleassistenza

A richiesta dell'utente, il nostro servizio tecnico interno si può collegare direttamente al vostro computer e controllare on-line il problema, dialogando tramite la CHAT.

Documenti, Manuali e Download

Tutte le informazioni tecniche e commerciali sono disponibili nella sezione dei documenti.

Condizioni generali di trasporto e vendita

- 1) I prezzi del listino sono espressi in euro, IVA esclusa, non sono impegnativi e si intendono per merce resa franco stabilimento di Bonavigo (Verona) Italia.
- 2) Qualora la merce per consegne Italia venisse spedita franco destino sarà calcolato un addebito in fattura del 3% sull'imponibile a titolo di concorso **spese trasporto**.
- 3) L'importo degli ordini minimo con consegna prevista da sede centrale di Bonavigo è di **300,00 Euro imponibile**.
In caso di deroga per ordini inferiori all'importo minimo sarà addebitato a titolo di contributo fisso forfettario per "gestione ordine minimo", l'importo di 20,00 Euro.
- 4) I **depositi regionali** permettono di effettuare consegne immediate del materiale disponibile (principalmente in fascia A).
- 5) In caso di insoluti verranno innanzitutto bloccate tutte le spedizioni e tutti gli ordini in corso verranno automaticamente sospesi: al momento del pagamento/sblocco dell'insoluto, gli ordini avranno i tempi di consegna partendo dalla data di sblocco e ricalcolati con le fasce di consegna presenti nel listino.
- 6) Il destinatario è obbligato a controllare la merce in arrivo e a contestare subito gli eventuali danni direttamente al trasportatore che ne è responsabile.
È diritto del destinatario e dovere del trasportatore controllare la spedizione (senza aprire l'imballo) e apporre le eventuali riserve specifiche sul DDT del trasportatore e quello SAMO. La sola dicitura generica: "RISERVA DI CONTROLLO" non è valida.
- 7) **Danno occulto**: nel caso di colli rovinati, solo esternamente, questi possono essere ritirati indicando sui DDT (documento di trasporto) del trasportatore e di SAMO la clausola "RISERVA CONTROLLO", specificando la motivazione per cui si è posta la riserva, come previsto dal regolamento (DPR 450 2/8/85) vigente. Nel caso di rotture accertate, il destinatario deve darne comunicazione scritta a mezzo raccomandata a SAMO e per conoscenza al trasportatore spedendola entro e non oltre 8 giorni dal ricevimento merce.
- 8) **Danno accertabile**: nel caso di danno evidente ed accertabile anche dal trasportatore, deve essere posta una riserva sul DDT del trasportatore e di SAMO indicando chiaramente quantità e codici danneggiati ed il tipo di danno esterno ed interno riscontrato.
Copia dei DDT devono essere inviati all'ufficio clienti SAMO che successivamente darà le opportune disposizioni per l'eventuale sostituzione e reso del materiale.
- 9) Diversamente da quanto previsto ai paragrafi 7 e 8, SAMO non riconoscerà alcun rimborso per danni o rotture riscontrate.
- 10) Nessun articolo può essere reso senza l'autorizzazione scritta da SAMO S.p.A.: i resi autorizzati dovranno pervenire in porto franco al ns. stabilimento utilizzando il trasportatore ed il numero di riferimento comunicati da SAMO. Il numero di riferimento deve essere riportato sul documento di trasporto.
Se nell'accurato controllo SAMO si riscontrassero incurie dell'acquirente, il materiale reso sarà gravato di un importo per la copertura delle spese generali oltre ad eventuali spese di ripristino a nuovo.
- 11a) Gli ordini sono soggetti all'approvazione di SAMO S.p.A.
Nessun ordine potrà essere annullato o modificato senza il consenso di SAMO S.p.A., che si riserva la facoltà di addebitare eventuali oneri e spese che ne derivano.
La conferma dell'avvenuto annullamento o modifica, come anche dell'importo addebitato, sarà effettuata unicamente da SAMO S.p.A. in forma scritta.
- 11b) Il cliente-mittente referente della spedizione del reso deve rendere il materiale autorizzato disponibile ed imballato idoneamente per il trasporto alla data di ritiro indicata nell'autorizzazione concordata. In caso contrario, SAMO SpA si riserva la facoltà di addebitare al cliente-mittente i costi di competenza conseguenti al mancato ritiro.
- 12) I prezzi di questo listino non sono contrattuali: gli ordini vengono accettati a prezzi e condizioni in vigore alla data di spedizione.
- 13) Per fatture inferiori a 300,00 Euro di imponibile, SAMO si riserva la facoltà di modificare le condizioni di pagamento.
- 14) L'imballo normale è gratuito, eventuali imballi rinforzati saranno addebitati al costo.
- 15) **FASCE DI CONSEGNA INDICATIVE:**
tutti i prodotti SAMO sono selezionati per fasce (A-B-C) in funzione della disponibilità media di magazzino e dei tempi di preparazione e spedizione.
La fascia A (con più alto indice di rotazione) è evidenziata con il carattere del prezzo su sfondo azzurro e indica una consegna indicativa di 1-2 settimane dal momento della conferma ordine.
La fascia B è evidenziata con prezzo su sfondo rosa e indica una consegna indicativa di 2-3 settimane dalla conferma ordine.
La fascia C (basso indice di rotazione) è evidenziata con carattere del prezzo su sfondo grigio e indica una consegna indicativa di 3-4 settimane.
"Per la consegna dei prodotti con trattamento StarClean bisogna calcolare una settimana in più rispetto alla fascia di appartenenza del codice articolo".
La disponibilità immediata dei prodotti a magazzino può anche essere richiesta inviando una e-mail all'indirizzo: giacenza-it@samo.it
- 16) I termini fissati per la spedizione non sono tassativi e in nessun caso possono costituire pretesto per ritardati pagamenti o richieste di risarcimento danni. Gli ordini possono essere anche evasi parzialmente.
- 17) In caso di particolari esigenze logistiche/operative, è possibile richiedere consegne e spedizioni personalizzate (pallettizzate, su ceste di ferro, con linea diretta, etc.) inviando una e-mail all'indirizzo servizioclienti@samo.it in modo da concordare tipologia, tempistiche ed eventuale maggiorazione per spese di trasporto e/o per spese di realizzo imballo.
- 18) Le spedizioni vengono eseguite con il mezzo giudicato più idoneo da SAMO S.p.A. e la merce viaggia a rischio e pericolo del committente, anche se spedita per speciali accordi, franco destino.

- 19) I prodotti non a catalogo e/o fabbricati su specifica richiesta del committente non possono essere restituiti.
- 20) I pagamenti dovranno essere effettuati puntualmente al domicilio di Bonavigo e secondo le condizioni stabilite: qualsiasi contestazione non darà diritto all'acquirente di trattenere somme dovute per fatture in essere e/o scadute.
- 21) In mancanza di speciali pattuizioni il pagamento si intende alla consegna.
- 22) I termini di pagamento dovranno essere tassativamente osservati. Sui ritardati pagamenti decorreranno gli interessi legali aggiornati al momento (DL 9/10/2002 n° 231), salvo il diritto di SAMO di sospendere o annullare ogni altra consegna senza pregiudizio di ogni altra azione o diritto.
- 23) I prodotti forniti rimangono di proprietà di SAMO S.p.A. fino ad integrale pagamento del prezzo, come previsto dal C.C. art. 1523 e segg.
- 24) **Garanzia.** SAMO SpA garantisce i propri prodotti per **24 mesi a decorrere dalla data d'acquisto** e comunque entro i limiti del DPR 224 24/05/88 e secondo le direttive Europee.
La garanzia copre esclusivamente vizi e difetti di fabbricazione o assemblaggio.
Difetti estetici o strutturali devono essere comunicati per iscritto a SAMO SpA solo ed esclusivamente prima dell'installazione, allegando i documenti di acquisto e di prodotto.
- 25) La garanzia impegna SAMO SpA solo alla riparazione e/o alla sostituzione degli elementi difettosi: sono pertanto escluse ulteriori pretese da parte dell'acquirente, ed esclude qualsiasi indennizzo derivato dal disagio, od onere o costo relativo accessorio.
La non conformità dovrà essere riconosciuta solo da parte di personale autorizzato da SAMO SpA.
- 26) Sono comunque esclusi dalla garanzia i seguenti casi:
- Se il difetto è riconducibile al trasporto.
 - Rotture di tutte le parti in vetro temperato, in particolare causate da impatto, urti durante il trasporto, movimentazione manuale degli elementi in fase di installazione e impatti accidentali durante l'utilizzo.
 - Se l'installazione non è stata eseguita dettagliatamente secondo istruzioni SAMO.
 - Se il vizio di funzionamento è conseguente ad un intervento sul prodotto non autorizzato.
 - Se il funzionamento difettoso è conseguente alla normale usura del prodotto, alla negligenza o incuranza da parte dell'acquirente nel rispetto delle indicazioni allegate al prodotto.
 - Se il difetto è riconducibile all'utilizzo di detersivi abrasivi, a base acida, o prodotti non adatti alla pulizia di superfici laccate, verniciate, anodizzate e vetrose.
Si consiglia l'utilizzo di articoli per la cura del prodotto a marchio SAMO.
 - Se il funzionamento difettoso è conseguente a forze maggiori.
 - Manomissione del prodotto da parte dell'acquirente.
- 27) SAMO SpA declina qualsiasi responsabilità per eventuali danni a persone, animali o cose causati da errori di installazione, di regolazione, imperfetto utilizzo o la mancata osservanza di tutte le prescrizioni indicate nella documentazione allegata al prodotto.
- 28) SAMO si riserva il diritto di apportare modifiche tecniche ed estetiche ai propri prodotti in qualsiasi momento senza preavviso, ivi comprese modifiche a volume e peso.
- 29) Ogni eventuale pattuizione che possa derogare, in tutto o in parte, alle presenti condizioni generali, deve risultare da espresso accordo scritto.
- 30) Il presente listino prezzi annulla tutti i precedenti ed è valido solo per vendite a ditte italiane.
- 31) Per ogni controversia è competente unicamente il Foro di VERONA - ITALIA.
- 32) Ai sensi della legge DL 196/2003 SAMO S.p.A. dichiara che i dati messi a disposizione dal committente verranno elaborati in rispetto della legge sulla tutela della privacy.
- 33) Tutte le suddette condizioni di vendita si intendono integralmente accettate con il conferimento dell'ordine.

Contatti commerciali di riferimento



l'esperienza italiana della doccia

SAMO S.P.A.
Via Cav. Orvile Venturato, 1
37040 BONAVIGO (VR) – ITALY
Tel. +39 (0) 442 73018
Fax +39 (0) 442 670033
www.samo.it - samo@samo.it
e-mail: samo@samo.it

Legenda simboli

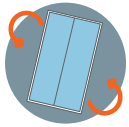

Reversibile per lato apertura



Abbinabile a parete fissa



Estesibilità e regolazione fuorisquadra



Profilo di compensazione

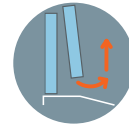

Sganciamento anta

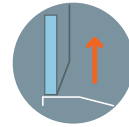

Sollevamento anta in apertura/chiusura



Chiusura magnetica



Frangiflutto o profilo di base



Guarnizione inferiore di tenuta con gocciolatoio



Guarnizione inferiore con gocciolatoio



Guarnizione fermavetro

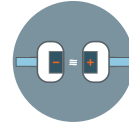

Chiusura magnetica ammortizzata

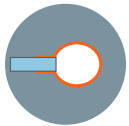

Guarnizione a palloncino

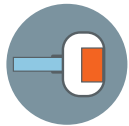

Profilo magnetico ammortizzato



Scorrimento a rotellina



Scorrimento a cuscinetto



Regolazione eccentrico

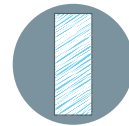

Pannelli in polystyrene

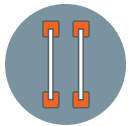

Maniglia



Pomello



Cerniera

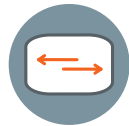

Cerniera estensibile



Cerniera sollevabile



Zanca di sostegno



Chiusura magnetica a scomparsa



Piletta di serie ispezionabile



Chiusura ammortizzata Soft Closing



Adatto a apertori di handicap



NON reversibile



NON abbinabile a parete fissa



Prestazione tenuta d'acqua Ottimale



Prestazione tenuta d'acqua Buona



Prestazione tenuta d'acqua Non garantita



Volume imballo





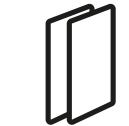





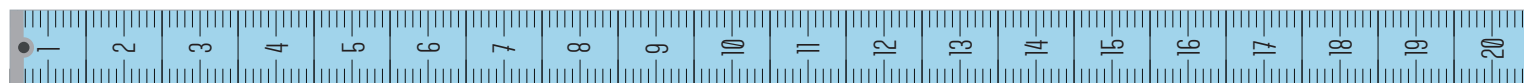



Peso imballo



Colli imballo

Prodotti speciali su misura



Standard	Tipo (Livello)	Forme SPECIALI			
 <p>ALTEZZA standard e LARGHEZZA standard di riferimento</p>	I	 ALTEZZA inferiore	 ALTEZZA superiore	 LARGHEZZA inferiore	 LARGHEZZA superiore
	II	 ALTEZZA inferiore LARGHEZZA inferiore	 ALTEZZA superiore LARGHEZZA inferiore	 ALTEZZA inferiore LARGHEZZA superiore	 ALTEZZA superiore LARGHEZZA superiore
	III	 VETRO ritagliato	 VETRO sopra muretto	 VETRO sagomato	 LARGHEZZA anta personalizzata
	IIII	SOLUZIONI DIVERSE da quelle contemplate nei livelli I, II, III: si veda la sezione dedicata da pag. 352 a pag. 363 CONTATTARE UFFICIO CLIENTI per avere la fattibilità e il prezzo			
	LARGHEZZE INTERMEDIE: sommare al prezzo della misura superiore.				

Stampa digitale per le serie Pyxis, Open, Zenith, Grand Polaris, Acrux, Cee Art e Cee Art SP.

Codice	Modelli	Descrizione	(€)
DD-DG-DH-DI-DK-DM-DN	Solo per lato angolo, porte battenti e pareti fisse	Considerare un aumento del prezzo rispetto alla finitura TR	175
DD-DG-DH-DI-DK-DM-DN	Open. Restanti modelli delle altre serie	Considerare un aumento del prezzo rispetto alla finitura TR	300

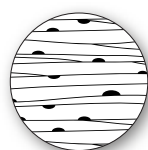

DD Brezza

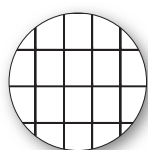

DG Griglia

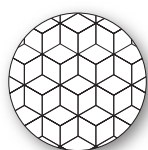

DH Cubix



DI Fronda



DK Exagon

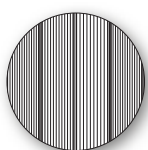

DM Wave



DN Rombi

Servizi PRE e POST vendita

Codice	Installazione cabina doccia	Descrizione	(€) prezzi netti	
KU7000.01	Montaggio cabina doccia	Uscita e installazione 1 parete	da 0 - 100 cm	145
KU7000.11			da 101 - 200 cm	200
KU7000.03	Montaggio cabina doccia	Uscita e installazione 2 pareti	da 0 - 100 cm	180
KU7000.33			da 101 - 200 cm	240
KU7000.10	Montaggio cabina doccia	Uscita e installazione 3 pareti	da 0 - 100 cm	250
KU7000.20			da 101 - 200 cm	290
KU7000.09	Montaggio pareti vasca, piatti doccia	Uscita installazione	120	
KU4000.01	Rilevazione misure	Uscita e rilevazione delle misure	80	

**SIAMO SOSTENIBILI.
SIAMO RESPONSABILI.**

Questo catalogo è Be Emission Free:
le emissioni di Co2 dell'intero processo
produttivo sono state compensate,
così da portare avanti il percorso sostenibile
intrapreso in questi anni da SAMO.





SAMO S.P.A. Via Cav. Orvile Venturato, 1 - 37040 BONAVIGO (VR) – ITALY
Tel. +39 (0) 442 73018 Fax +39 (0) 442 670033

www.samo.it